



Ethiopia France Germany Georgia Greece Hungary Iran Iraq Israel Italy Jordan



Romania Russia Saudi Arabia Senegal Sudan Syria Thailand Tunisia Turkmenistan Ukraine United Kingdom Uzbekistan



# SERTİFİKALAR

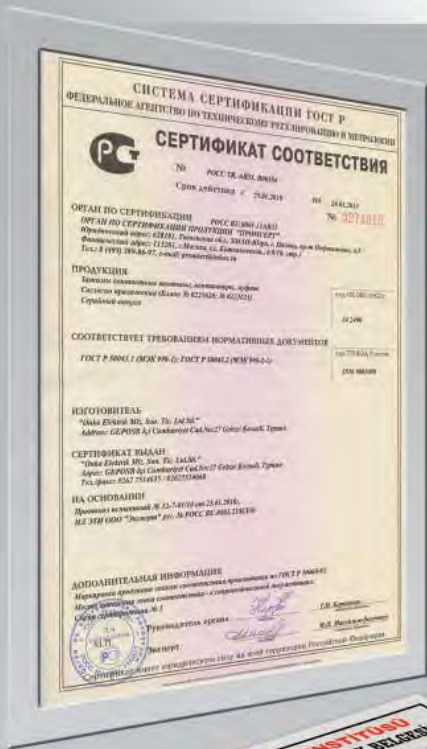

## İNDEKS

Alcu Branşman ve Durdurucu Klemensler	35
Bakır Bara ve Bağlantı Aparatları	21 - 24
Bant Armatür, Ralina Duy ve Şarjlı Işıldaklar	143
Bantlar	143
Buat İçi Klemens ve Aksesuarları	40 - 43
Cam Elyaf Makoronlar, Kablo Toplama Çorapları	142
Dağıtıcı Üniteler	17 - 20
Ek Muflar (Vidalı ve Sıkmalı)	32 - 33
Elektronik Kartlar ve Klemensler	73 - 86
Fanlar ve Aksesuarları	139
Güç Dağıtım Blokları ve Aksesuarları	91-97
Güç Klemensleri	23
Kablo Bağları	66 - 69
Kablo Etiketleri ve Aksesuarları	44 - 45
Kablo Uçları	51 - 65
Kablo Tutucuları ve Taşıyıcıları	70 - 72
Kondansatörler	106
Kumanda Kutuları, Limit Switchler, Anahtar Kontaktları	128
Makoronlar	141 - 142
Otomatik Sigorta ve Kontaktörler	129 - 130
Pano İçi Aksesuarları ve Ekranlama Klemensleri	140
Pano Kilitleri ve Aksesuarları	131 - 138
Pano Prizleri, Termostat ve Isıtıcılar	50
Pano Topraklama Klemensleri	16
Pano ve Kablo Toplama Spiralleri	142
Ray Klemensler MRK Serisi (Vidalı)	7 - 10
Ray Klemensler MPK Serisi (Push-in Sistem)	15
Ray Klemensler OPK Serisi (Push-in Sistem)	11-14
Raylar ve Aksesuarları	25 - 27
Rekorlar ve Aksesuarları	46 - 49
Röleler	87 - 90
Sıra Klemensler	37
Sinyal Lambaları ve Butonlar	129
SKP Papuçlar	28 - 31
Soket Klemensler	38
Sprey Çeşitleri	144
Tarak İzolatörler ve Mesnet İzolatörler	98 - 105
Tırnaklı Kroşe ve Sıra Klemens Aksesuarları	39
Trafo, Modül ve Porselen Klemensler	36
U, Tırnaklı, H ve C Klemensler	34
Yazıcılar ve Etiketler	107 - 127



AKIM TRAFOLARI



KONNEKTÖRLER



SİGORTALAR



FİŞ PRİZLER



İKAZ LAMBALARI VE SİRENLER

## TEDARİK EDİLEBİLİR ÜRÜNLER



GÜÇ RÖLELERİ VE ÖLÇÜM CİHAZLARI



OTOMASYON ÜRÜNLERİ



KUMANDA BUTONLARI VE PEDALLAR



PAKO ŞALTERLER



ŞALT GRUBU



SWITCHLER VE ANAHTARLAR



GÜÇ KAYNAKLARI VE TRAFOLAR



PİLLER VE JENERATÖRLER

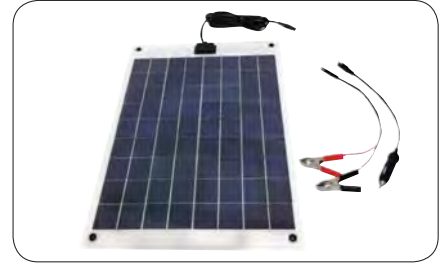

GÜNEŞ PANELLERİ



GRUP PRİZLER



BUATLAR



SOLİT STATE RÖLELER VE SOĞUTUCULAR



ÖLÇÜ ALETLERİ



EK MUFLAR VE BAŞLIKLAR

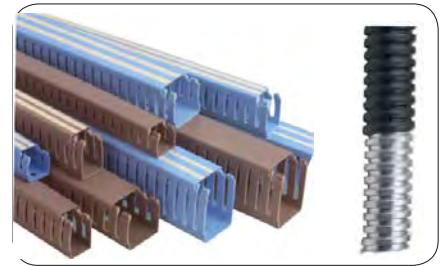

KABLO KANALLARI VE SİRALLER



Saygıdeğer Müşterimiz;

1986 yılından beri edinmiş olduğumuz deneyim ve bilgi birikimimiz sonucu "Onka Elektrik Malzemeleri Sanayi ve Ticaret Limited Şirketi" olarak üretim kalite, ekonomi ve hizmeti temel ilke olarak kabul etmiş olup, hergün portföyümüze yeni ürünler ekleyerek bu günkü ürün yelpazemize ulaşmış bulunmaktayız. Bunu daima sizin arzu ve istekleriniz doğrultusunda artırmayı kendimize hedef kabul ettik.

Pazarlama ve tedarikçilik konusunda edindiğimiz bilgi ve birikimlerimizi "Elektrokar Elektrik Malzemeleri Pazarlama Sanayi ve Ticaret Limited Şirketi" olarak sizlerle paylaşmaktayız. Her sene yenileyerek hazırladığımız katalog ve fiyat listemize göstermiş olduğunuz ilgiden dolayı bu çalışmalar geliştirerek sürdürmekteyiz.

Bizlere bu konuda yardımcı olan, çözüm ortaklarımız ve bayiliğini yaptığımız firmalara teşekkür ederiz.

Sizlere gerek yurtiçi gerekse yurtdışı ürün tedarikçiliği görevini sürdürmekteyiz. Bu konuda çalışmalarımız devam etmektedir.

Tedarikçiniz olarak bizleri seçmiş olmanızdan dolayı teşekkür eder mutluluk ve başarılar dileriz.

Yönetim Kurulu Başkanı  
Makine Mühendisi

**Kamil KARACA**



# VİDALI SİSTEM

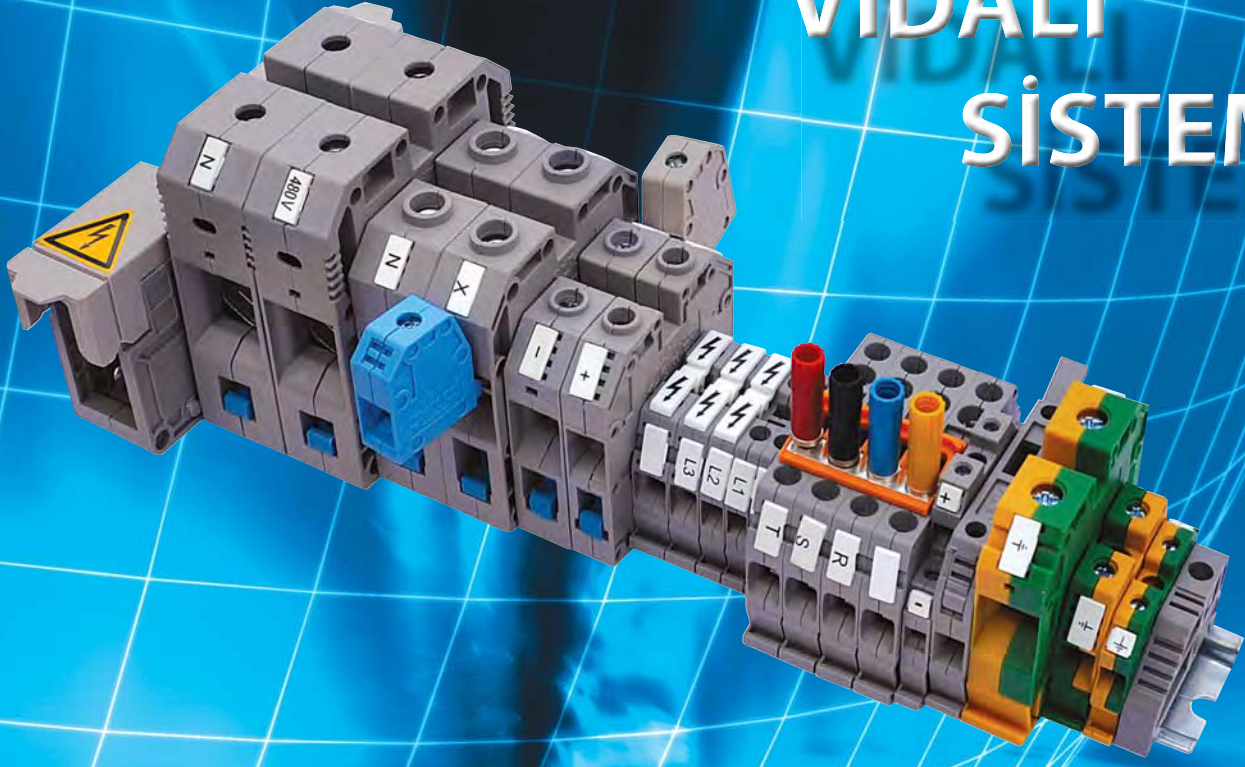

ONKA yeni MRK serisinde 1,5 mm<sup>2</sup> den 240 mm<sup>2</sup> ye kadar tüm kesitler mevcuttur. Yeni MRK serisinde 2,5 mm<sup>2</sup> den 10 mm<sup>2</sup> ye kadar klemensler yanyana dizdiğinizde aynı ebattadır. Sadece kablo kesitine göre klemensin kalınlığı değişmektedir.

ONKA Ray Klemenslerin tümünde polyamid 66 plastik hammaddesi kullanılmaktadır. V2 yanmazlık standartına sahiptir.

Yeni MRK serisinde 2,5 mm<sup>2</sup> den 10 mm<sup>2</sup> ye kadar izoleli tarak köprü kullanılmaktadır. 4 ve 10 mm<sup>2</sup> lik topraklama klemensinin devamında 16 ve 35 mm<sup>2</sup> lik Topraklama klemensi üretilmiştir.

Yeni MRK serisinde bir diğer yeni ürün de "MRK TEST-10" ölçme ve ayırma (Test) klemensi. Sürgülü köprü ile rahatlıkla köprülenebilmektedir. Üzerine takılabilen test kovanları sayesinde ölçü aletinin test propları test kovanlarına saplanıp rahatlıkla ölçüm alınabilir. Ölçme ve ayırma klemensinin iç yapısında hareketli aksamın fazla olması sebebi ile ONKA ile özdeşleşmiş bir özellik olan, klemensin her iki tarafının kapalı olması ölçme ve ayırma klemensinde önemini bir kat daha arttırmaktadır. Tek tarafı açık olan diğer markalarda klemensin içindeki hareketli aksamın dağılıp döküldüğünü görmekteyiz. Fakat ONKA da böyle bir durumun yaşanması mümkün değildir.

## Teknik özellikler:

- Nihayet plakası gerektirmez (Her iki tarafı kapalı) Maliyet tasarrufu ve daha iyi bir izolasyon sağlar.
- Simetrik tir (Her iki yönde raya monte edilebilir)
- 0,06 mm<sup>2</sup> den 240 mm<sup>2</sup> lik kablo kesitine kadar montaj imkanı sağlar.
- Markalama tırnak yapısında Grafoplast ve diğer markalara uygun tırnak yapısı.
- Şerit markalamaya uygun etiketleme sistemi.
- Çift yönlü köprüleme imkanı.
- 2,5 mm<sup>2</sup> den 10 mm<sup>2</sup> ye kadar izoleli tarak köprü kullanılabilir.
- Renk alternatiflerinin çok hızlı bir şekilde teslim edilmesi.
- Çift renk yapılabilme özelliği.
- Vida sistemi 1,5 mm<sup>2</sup> den 35 mm<sup>2</sup> ye kadar düz başlıdır.
- Vida sistemi 50 mm<sup>2</sup> ve sonraki kesitlerde alyan başlıdır.
- MRK Serisi durdurucu hem grup etiketi hemde durdurucu olarak kullanılabilir.

## TAKILABİLEN RAY ÇEŞİTLERİ

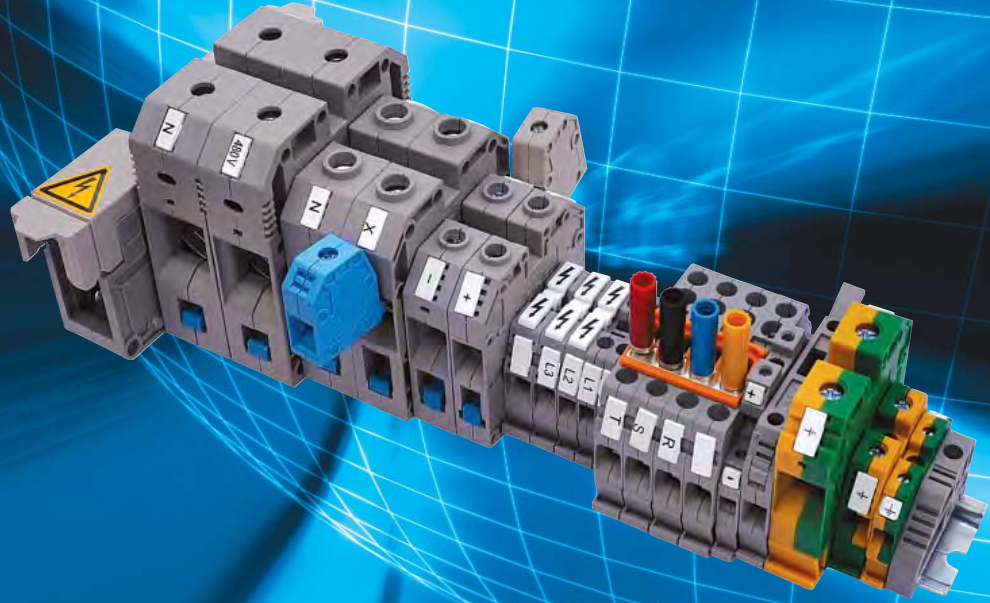
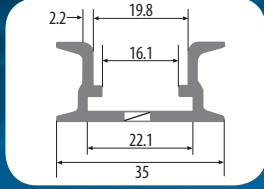
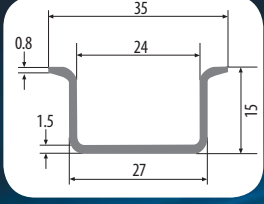
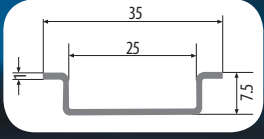

11 mm KAĞIT ETİKET TAKILABİLİR.

## MRK SERİSİ VİDALI RAY KLEMENSLER (KAPALI SİSTEM)

KOD	CİNSİ	KABLO KESİTİ	VOLTAJ (V)	AMPER (A)	AD. / ʘ	K. ADEDİ
ONKA-1001	MRK - 1,5 mm <sup>2</sup>	1,5 mm <sup>2</sup>	750V	17.5 A	0.65	100
ONKA-1011	MRK - 2,5 mm <sup>2</sup>	2,5 mm <sup>2</sup>	750V	24 A	0.66	100
ONKA-1021	MRK - 4 mm <sup>2</sup>	4 mm <sup>2</sup>	750V	32 A	0.80	100
ONKA-1031	MRK - 6 mm <sup>2</sup>	6 mm <sup>2</sup>	750V	41 A	1.30	100
ONKA-1041	MRK - 10 mm <sup>2</sup>	10 mm <sup>2</sup>	750V	57A	1.75	100
ONKA-1051	MRK - 16 mm <sup>2</sup>	16 mm <sup>2</sup>	750V	76 A	2.60	50
ONKA-1061	MRK - 35 mm <sup>2</sup>	35 mm <sup>2</sup>	750V	125 A	4.50	30
ONKA-1071	MRK - 50 mm <sup>2</sup>	50 mm <sup>2</sup>	750V	150 A	16.00	20
ONKA-1081	MRK - 70 mm <sup>2</sup>	70 mm <sup>2</sup>	750V	192 A	19.50	20
ONKA-1091	MRK - 95 mm <sup>2</sup>	95 mm <sup>2</sup>	1000V	232 A	26.00	10
ONKA-1101	MRK - 120 mm <sup>2</sup>	120 mm <sup>2</sup>	1000V	269 A	29.00	10
ONKA-1111	MRK - 150 mm <sup>2</sup>	150 mm <sup>2</sup>	1000V	309 A	32.00	10
ONKA-1121	MRK - 185 mm <sup>2</sup>	185 mm <sup>2</sup>	1000V	353 A	35.00	10
ONKA-1131	MRK - 240 mm <sup>2</sup>	240 mm <sup>2</sup>	1000V	415 A	38.00	10

## MRK RAY KLEMENS RENK KODLARI

GİRİ	KREM	SİYAH	MAVİ	KAHVERENGİ	KIRMIZI	SARI	YEŞİL
02	03	04	05	06	07	08	09

Çift Renk Klemens Üretilir.







**MRK SERİSİ PAPUÇ BAĞLANTILI BARALI RAY KLEMENSLER (KAPAKSIZ)**

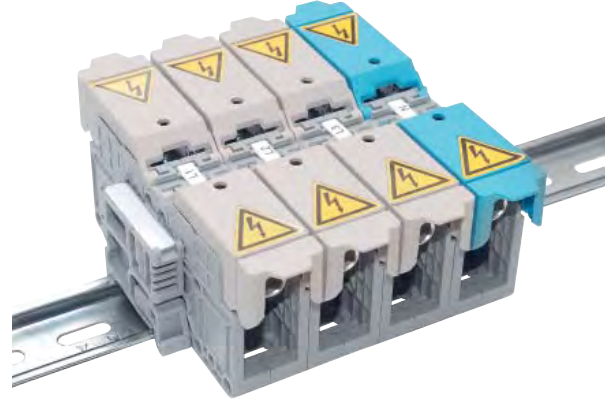

**MRK SERİSİ PAPUÇ BAĞLANTILI BARALI RAY KLEMENSLER (KAPAKLI)**



KOD	CİNSİ	AD. / ʘ	K. ADEDİ
ONKA-2311	25 mm <sup>2</sup>	12.75	10
ONKA-2331	35 mm <sup>2</sup>	13.50	10
ONKA-2351	50 mm <sup>2</sup>	14.50	10
ONKA-2371	70 mm <sup>2</sup>	19.25	10
ONKA-2391	95 mm <sup>2</sup>	21.25	10
ONKA-2411	120 mm <sup>2</sup>	23.00	10
ONKA-2431	150 mm <sup>2</sup>	25.00	10
ONKA-2451	185 mm <sup>2</sup>	31.00	10
ONKA-2471	240 mm <sup>2</sup>	36.00	10

KOD	CİNSİ	AD. / ʘ	K. ADEDİ
ONKA-2301	25 mm <sup>2</sup>	15.50	10
ONKA-2321	35 mm <sup>2</sup>	16.25	10
ONKA-2341	50 mm <sup>2</sup>	17.50	10
ONKA-2361	70 mm <sup>2</sup>	24.00	10
ONKA-2381	95 mm <sup>2</sup>	26.25	10
ONKA-2401	120 mm <sup>2</sup>	28.00	10
ONKA-2421	150 mm <sup>2</sup>	30.00	10
ONKA-2441	185 mm <sup>2</sup>	38.00	10
ONKA-2461	240 mm <sup>2</sup>	44.00	10

**MRK TEST KLEMENS 6'LIK (Bıçaklı Kapalı Sistem)**

**MRK TEST KLEMENSİ ÜST KÖPRÜ VE TEST KOVANI**



KOD	CİNSİ	AD. / ʘ	K. AD.
ONKA-1317	Bıçaklı Sistem Çift Kovanlı	4.00	100



KOD	CİNSİ	AD. / ʘ	K. AD.
ONKA-1318	4'lü Üst Köprü	1.50	50
ONKA-1319	Test Kovanı	1.00	50

**MRK TEST KLEMENS 10'LUK**

**MRK TEST KLEM. 10'LUK TEST KOVANI VE ÜST KÖP.**



KOD	CİNSİ	AD. / ʘ	K. AD.
ONKA-1313	Kovansız	4.60	75
ONKA-1314	Tek Kovanlı	5.20	75
ONKA-1315	Çift Kovanlı	5.90	75



KOD	CİNSİ	AD. / ʘ	K. AD.
ONKA-1324	4'lü Set Çift Kovanlı 4'lü Set Köprülü Test Kovanlı	27.00	100

## MRK SERİSİ EK KLEMENS



KOD	CİNSİ	AD. / ʘ	K. AD.
ONKA-1161	Maksimum 16 mm <sup>2</sup> Köprü Boyu 18 mm 35-50 mm Klemens	1.85	100
ONKA-1171	Maksimum 16 mm <sup>2</sup> Köprü Boyu 23 mm 70-95-120 mm Klemens	1.95	100

## MRK SERİSİ EK TOPRAKLAMA KLEMENSLERİ



KOD	CİNSİ	AD. / ʘ	K. AD.
ONKA-1293	MTK 4 mm <sup>2</sup>	3.46	100
ONKA-1294	MTK 10 mm <sup>2</sup>	4.10	100
ONKA-1295	MTK 16 mm <sup>2</sup>	6.95	50
ONKA-1296	MTK 35 mm <sup>2</sup>	7.95	30

## MRK SERİSİ ÇİFT KATLI RAY KLEMENSLER



KOD	CİNSİ	KABLO KESİTİ	VOLTAJ (V)	AMPER (A)	AD. / ʘ	K. ADEDİ
ONKA-1611	MRK -Ç 2,5 mm <sup>2</sup>	2,5 mm <sup>2</sup>	500 V	24 A	2.10	50
ONKA-1621	MRK -Ç 2,5 mm <sup>2</sup> Köprülü	2,5 mm <sup>2</sup>	500 V	24 A	4.70	50
ONKA-1631	MRK -Ç 2,5 mm <sup>2</sup> Diyotlu	2,5 mm <sup>2</sup>	500 V	24 A	3.90	50
ONKA-1641	MRK -Ç 2,5 mm <sup>2</sup> Ledli AC/DC	2,5 mm <sup>2</sup>	500 V	24 A	5.60	50
ONKA-1651	MRK -Ç 4 mm <sup>2</sup>	4 mm <sup>2</sup>	500 V	32 A	2.60	50
ONKA-1661	MRK -Ç 4 mm <sup>2</sup> Köprülü	4 mm <sup>2</sup>	500 V	32 A	5.20	50
ONKA-1671	MRK -Ç 4 mm <sup>2</sup> Diyotlu	4 mm <sup>2</sup>	500 V	32 A	4.40	50
ONKA-1681	MRK -Ç 4 mm <sup>2</sup> Ledli AC/DC	4 mm <sup>2</sup>	500 V	32 A	6.10	50
ONKA-1691	MRK -Ç 6 mm <sup>2</sup>	6 mm <sup>2</sup>	500 V	41 A	3.60	50
ONKA-1701	MRK -Ç 6 mm <sup>2</sup> Köprülü	6 mm <sup>2</sup>	500 V	41 A	6.20	50
ONKA-1711	MRK -Ç 6 mm <sup>2</sup> Diyotlu	6 mm <sup>2</sup>	500 V	41 A	5.40	50
ONKA-1911	MRK -Ç 6 mm <sup>2</sup> Ledli AC/DC	6 mm <sup>2</sup>	500 V	41 A	7.10	50

## MRK-S SERİSİ SİĞORTALI RAY KLEMENSLER BARALI VE LEDLİ



KOD	CİNSİ	KABLO KESİTİ	VOLTAJ (V)	AMPER (A)	AD. / ʘ	K. ADEDİ
ONKA-1272	MRK-S 6 mm <sup>2</sup>	6 mm <sup>2</sup>	Boş	6.3 A	3.45	100
ONKA-1273	MRK-S 6 mm <sup>2</sup>	6 mm <sup>2</sup>	Baralı	6.3 A	4.00	100
ONKA-1274	MRK-S 6 mm <sup>2</sup>	6 mm <sup>2</sup>	24 V AC LED	6.3 A	6.50	100
ONKA-1275	MRK-S 6 mm <sup>2</sup>	6 mm <sup>2</sup>	24 V DC LED	6.3 A	6.50	100
ONKA-1276	MRK-S 6 mm <sup>2</sup>	6 mm <sup>2</sup>	48 V AC LED	6.3 A	6.50	100
ONKA-1277	MRK-S 6 mm <sup>2</sup>	6 mm <sup>2</sup>	48 V DC LED	6.3 A	6.50	100
ONKA-1278	MRK-S 6 mm <sup>2</sup>	6 mm <sup>2</sup>	110 V AC LED	6.3 A	6.50	100
ONKA-1279	MRK-S 6 mm <sup>2</sup>	6 mm <sup>2</sup>	110 V DC LED	6.3 A	6.50	100
ONKA-1280	MRK-S 6 mm <sup>2</sup>	6 mm <sup>2</sup>	220 V AC LED	6.3 A	6.50	100
ONKA-1281	MRK-S 6 mm <sup>2</sup>	6 mm <sup>2</sup>	220 V DC LED	6.3 A	6.50	100

# YAYLI SİSTEM

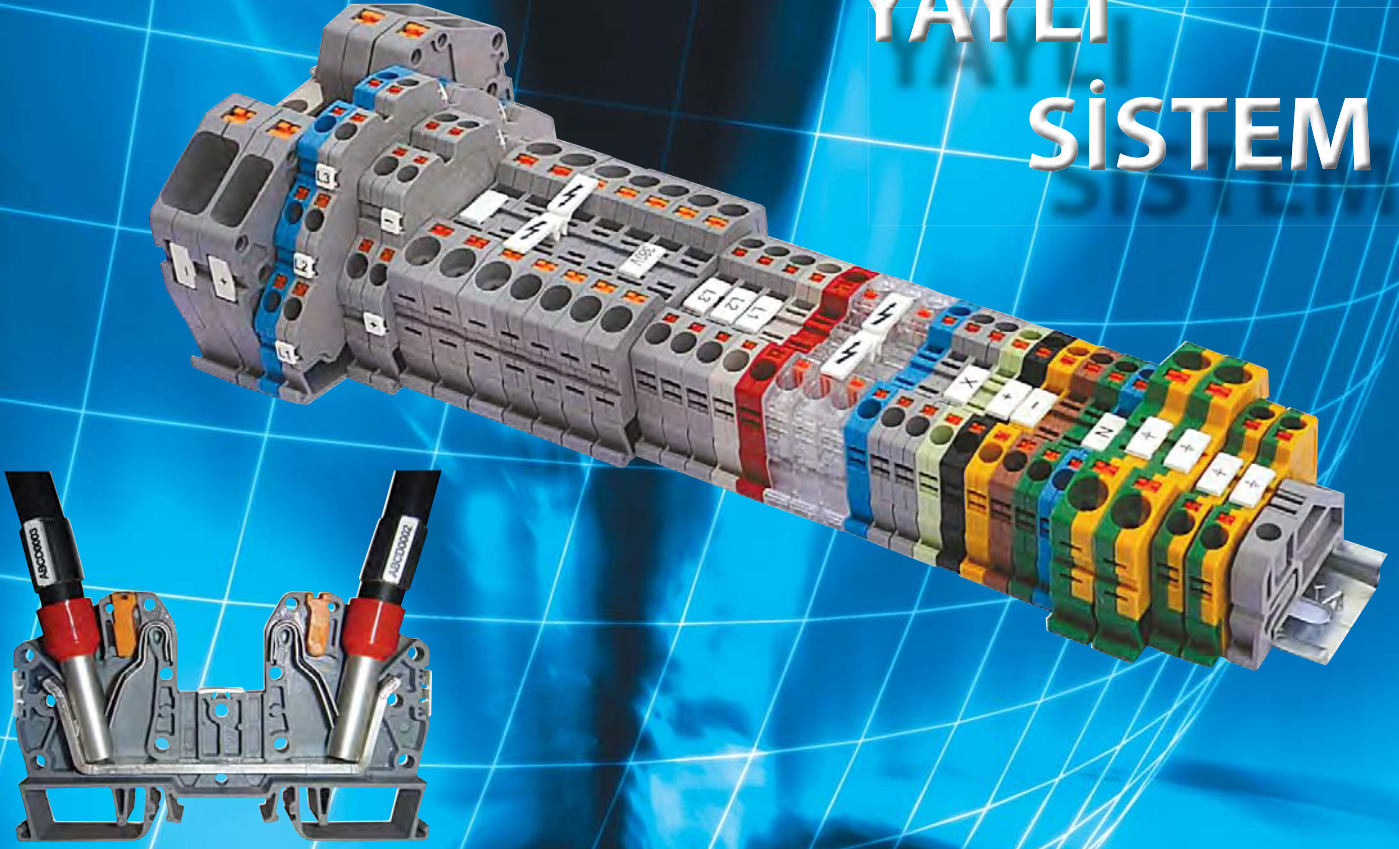

ONKA Yeni ürettiği OPK (Push-in) yay baskılı klemensler de serisini tamamlayarak, 2,5-4-6-10-16-35 mm<sup>2</sup> lik Klemensleri, 2,5-4 mm<sup>2</sup> lik iki katlı Klemensler ve 4-10 mm<sup>2</sup> Raydan Topraklamalı Topraklama Klemensini ürün gamına eklemiştir.

ONKA Ray Klemenslerin tümünde polyamid 66 plastik hammaddesi kullanılmaktadır. V2 yanmazlık standartına sahiptir.

ONKA yeni ürettiği 16 mm<sup>2</sup> ve 35 mm<sup>2</sup> OPK (Push-in) yay baskılı klemensler de daha önce hiçbir markanın yapmadığı bir sistemi uygulayarak çift yay sistemini geliştirmiştir. Bu sayede montajı tamamlanan kabloyu geri çekmek istediğinizde iki katı mukavemet ile karşılaşacaksınız. Buda yüksek kesitlerde yay baskılı klemense olan güveni daha da arttırmaktadır.

ONKA yeni OPK (Push-in) serisinde diğer markalarda olmayan diğer bir özellik de 2,5 mm<sup>2</sup> den 35 mm<sup>2</sup> lik kablo kesitine kadar serinin tamamlanmış olmasıdır.

OPK yay baskılı Klemensler sürekli gelişen ve yenilenen günümüz teknoloji çağında Teknik Kadronun işini kolaylaştıracak, daha hızlı ve kolay montaj yapabileceği uzun ömürlü bir bağlantı teknolojisidir

Teknik özellikler:

- Push-in Sistem.
- Nihayet plakası gerektirmez (Her iki tarafı kapalı) Maliyet tasarrufu ve daha iyi bir izolasyon sağlar.
- Simetrik (Her iki yönde raya monte edilebilir)
- Daha düşük kablo itme kuvveti.
- Zaman ve maliyet tasarrufu.
- Turuncu butonlar sayesinde montaj esnasında iletken kısma sıfır temas.
- Yaylar paslanmaz çelik.
- 0,50 mm<sup>2</sup> den 35 mm<sup>2</sup> ye kadar yüksüklü kablolarda hiçbir el aleti gerektirmeden montaj imkanı.
- Markalama tırnak yapısında Grafoplast ve diğer markalara uygun tırnak yapısı.
- Şerit markalamaya uygun etiketleme sistemi.
- Çift yönlü köprüleme imkanı.
- İzoleli tarak köprü
- Renk alternatiflerinin çok hızlı bir şekilde teslim edilmesi.
- Çift renk yapılabilmek özelliği.

## TAKILABİLEN RAY ÇEŞİTLERİ

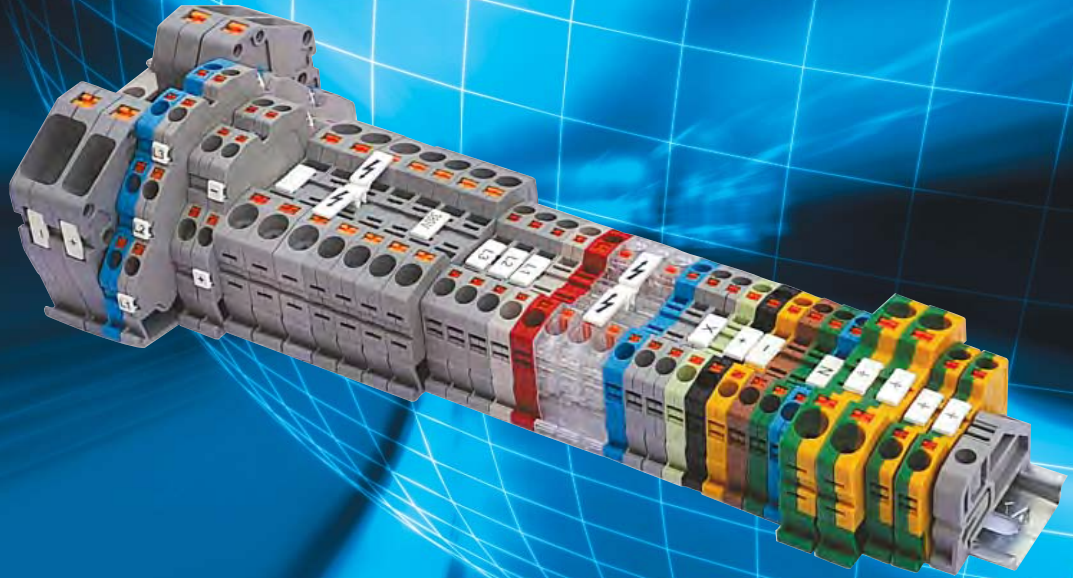
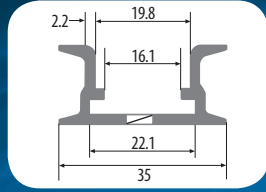
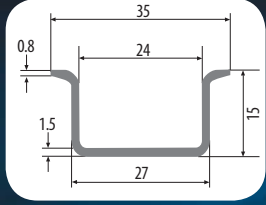
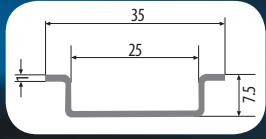

11 mm KAĞIT ETİKET TAKILABİLİR.

## OPK SERİSİ YAY BASKILI RAY KLEMENSLER (PUSH-IN SİSTEM)

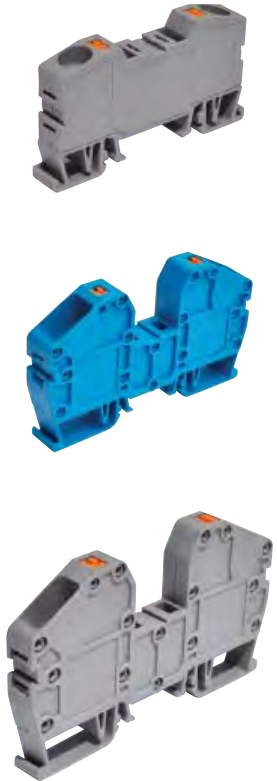

KOD	CİNSİ	KABLO KESİTİ	VOLTAJ (V)	AMPER (A)	AD. / ʈ	K. ADEDİ
ONKA-1180	OPK - 1,5 mm <sup>2</sup>	1,5 mm <sup>2</sup>	750V	17 A	0.67	100
ONKA-1501	OPK - 2,5 mm <sup>2</sup>	2,5 mm <sup>2</sup>	750V	24 A	0.68	100
ONKA-1511	OPK - 4 mm <sup>2</sup>	4 mm <sup>2</sup>	750V	32 A	0.84	100
ONKA-1521	OPK - 6 mm <sup>2</sup>	6 mm <sup>2</sup>	750V	41 A	1.44	100
ONKA-1531	OPK - 10 mm <sup>2</sup>	10 mm <sup>2</sup>	750V	57A	2.00	100
ONKA-1541	OPK - 16 mm <sup>2</sup>	16 mm <sup>2</sup>	750V	76 A	4.68	30
ONKA-1551	ORK - 35 mm <sup>2</sup>	35 mm <sup>2</sup>	750V	125 A	5.80	20

## OPK SERİSİ YAY BASKILI RAY KLEMENSLER RENK KODLARI

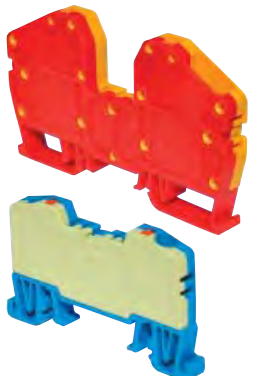

GRI	KREM	SİYAH	MAVİ	KAHVERENGİ	KIRMIZI	SARI	YEŞİL
02	03	04	05	06	07	08	09

Çift Renk Klemens Üretilir.



## OPK SERİSİ YAY BASKILI İKİ KATLI KLEMENSLER



KOD	CİNSİ	KABLO KESİTİ	VOLTAJ (V)	AMPER (A)	AD. / ʘ	K. ADEDİ
ONKA-1721	OPK -Ç 2,5 mm <sup>2</sup>	2,5 mm <sup>2</sup>	500 V	24 A	2.10	50
ONKA-1731	OPK - 2,5 mm <sup>2</sup> Köprülü	2,5 mm <sup>2</sup>	500 V	24 A	4.15	50
ONKA-1741	OPK - 2.5 mm <sup>2</sup> ↓ Diyotlu Yönlü ↑	2,5 mm <sup>2</sup>	500 V	24 A	3.48	50
ONKA-1751	OPK - 4 mm <sup>2</sup>	4 mm <sup>2</sup>	500 V	32 A	2.23	50
ONKA-1761	OPK - 4 mm <sup>2</sup> Köprülü	4 mm <sup>2</sup>	500 V	32 A	4.53	50
ONKA-1771	OPK - 4 mm <sup>2</sup> Diyetolu Yönlü	4 mm <sup>2</sup>	500 V	32 A	3.89	50

## OPK SERİSİ YAY BASKILI ÜÇ KATLI KLEMENSLER



KOD	CİNSİ	KABLO KESİTİ	VOLTAJ (V)	AMPER (A)	AD. / ʘ	K. ADEDİ
ONKA-1851	OPK - 3 2,5 mm <sup>2</sup>	2,5 mm <sup>2</sup>	500 V	24 A	3.80	50
ONKA-1861	OPK - 3 2,5 mm <sup>2</sup> Köprülü	2,5 mm <sup>2</sup>	500 V	24 A	5.20	50
ONKA-1871	OPK - 3 2.5 mm <sup>2</sup> Topraklı	2,5 mm <sup>2</sup>	500 V	24 A	6.90	50
ONKA-1881	OPK - 3 4 mm <sup>2</sup>	4 mm <sup>2</sup>	500 V	32 A	4.30	50
ONKA-1891	OPK - 3 4 mm <sup>2</sup> Köprülü	4 mm <sup>2</sup>	500 V	32 A	5.70	50
ONKA-1901	OPK - 3 4 mm <sup>2</sup> Topraklı	4 mm <sup>2</sup>	500 V	32 A	7.40	50

## OPK SERİSİ YAY BASKILI TOPRAKLAMA KLEMENSLERİ

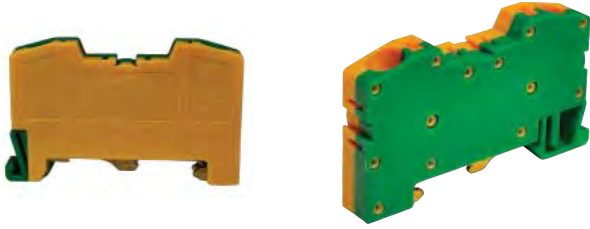

KOD	CİNSİ	KABLO KESİTİ	VOLTAJ (V)	AMPER (A)	AD. / ʘ	K. AD.
ONKA-1199	OPK - T 4 mm <sup>2</sup>	4 mm <sup>2</sup>	750 V	32 A	2.95	100
ONKA-1200	OPK - T 10 mm <sup>2</sup>	10 mm <sup>2</sup>	750 V	57 A	5.10	100

## MRK VE OPK SERİSİ DURDURUCU KÜÇÜK BOY



KOD	CİNSİ	AD. / ʘ	K. AD.
ONKA-1221	Küçük Durdurucu	0.73	100

## MRK VE OPK SERİSİ DURDURUCU BÜYÜK BOY



KOD	CİNSİ	AD. / ʘ	K. AD.
ONKA-1211	Büyük Durdurucu	1.20	100

## MRK VE OPK SERİSİ GRUP ETİKETLİ DURDURUCU



KOD	CİNSİ	AD. / ʘ	K. AD.
ONKA-1231	Grup Etiketli	1.25	100

## RAY MONTE KORUMA TUTUCU AYAĞI VE KAPAĞI



KOD	CİNSİ	AD. / ʘ	K. AD.
ONKA-1205	35'lik Tutucu Ayağı	ʘ	20
ONKA-1206	Koruma Kapağı	ʘ	mt.

## OPK SERİSİ YAY BASKILI RAY KLEMENSLER RENK KODLARI

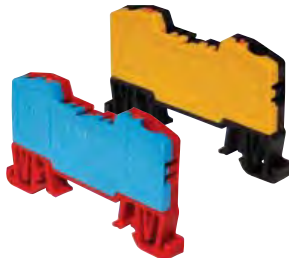

GRİ	KREM	SİYAH	MAVİ	KAHVERENGİ	KIRMIZI	SARI	YEŞİL
02	03	04	05	06	07	08	09

Çift Renk Klemens Üretilir.



## DEKAFİKSLER (MRK ve OPK SERİSİ)

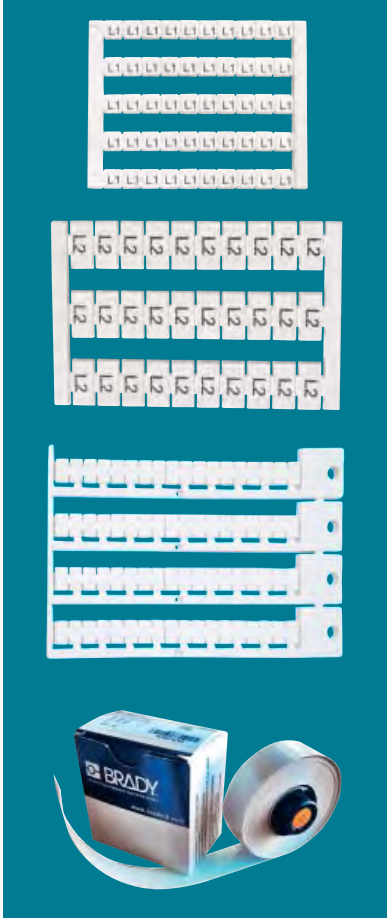

KOD	CİNSİ	AD. / ʈ	K. AD.
ONKA-9540	OD5-5 Baskısız	0.030	500
ONKA-9541	OD5-5B Baskılı	0.055	500
ONKA-9770	OD10-6 Baskısız	0.066	300
ONKA-9771	OD10-6B Baskılı	0.085	300
ONKA-4441	OD10-6P Baskısız - Baskılı	Ⓢ	720
BRAD-TLS-B7696	11 mm Şerit Etiket	Ⓢ	10 m

## RAY KLEMENS İŞARETLERİ VE ETİKET YUVASI

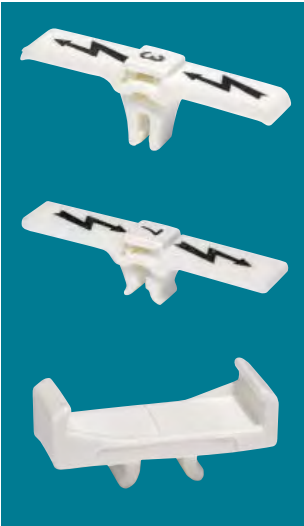

KOD	CİNSİ	AD. / ʈ	K. AD.
ONKA-1287	MRK Ray Klemens İşaretleme	0.750	1000
ONKA-1288	OPK Ray Klemens İşaretleme	0.750	1000
ONKA-1289	Ray Klemens 11-12 mm Etiket Yuvası	0.045	1000

# YAYLI SİSTEM

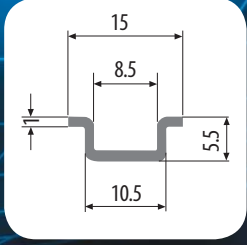

## MPK SERİSİ MİNİ YAY BASKILI KLEMENSLER (PUSH-IN SİSTEM)



KOD	CİNSİ	KABLO KESİTİ	VOLTAJ (V)	AD. / ʘ	K. AD.
ONKA-1421	MPK - 2,5 mm <sup>2</sup> 24 A	2,5 mm <sup>2</sup>	750V	0.65	100

## MPK SERİSİ MİNİ YAY BASKILI KLEMENSLER (İÇTEN KÖPRÜLÜ)

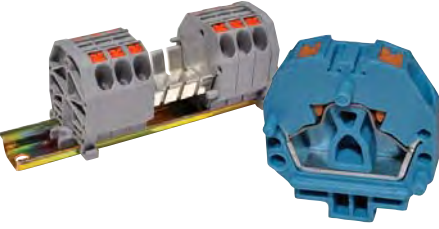

KOD	CİNSİ	KABLO KESİTİ	VOLTAJ (V)	AD. / ʘ	K. AD.
ONKA-1431	MPK - 2,5 mm <sup>2</sup> 24 A	2,5 mm <sup>2</sup>	750V	0.70	100

## MPK SERİSİ MİNİ YAY BASKILI KLEMENSLER (DURDURUCU VE SONLANDIRICI)



KOD	CİNSİ	AD. / ʘ	K. AD.
ONKA-1441	Durdurucu ve Sonlandırıcı Raya takılabilir ve zemine vidalanabilir.	0.26	100

## MPK SERİSİ MİNİ YAY BASKILI KLEMENSLER (DURDURUCU VE SONLANDIRICI)



KOD	CİNSİ	AD. / ʘ	K. AD.
ONKA-1451	Durdurucu ve Sonlandırıcı Zemine geçmeli.	0.26	100

## MPK RAY KLEMENS RENK KODLARI

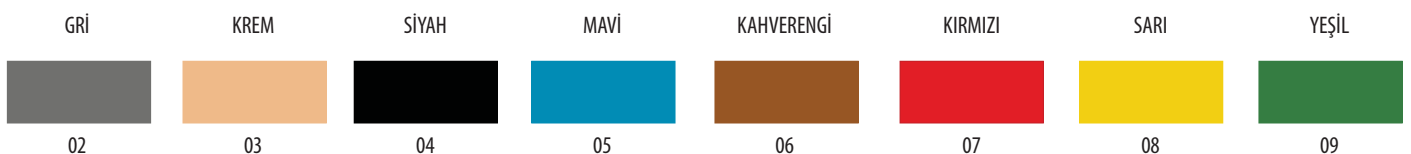

GRİ

KREM

SİYAH

MAVİ

KAHVERENGİ

KIRMIZI

SARI

YEŞİL

02

03

04

05

06

07

08

09

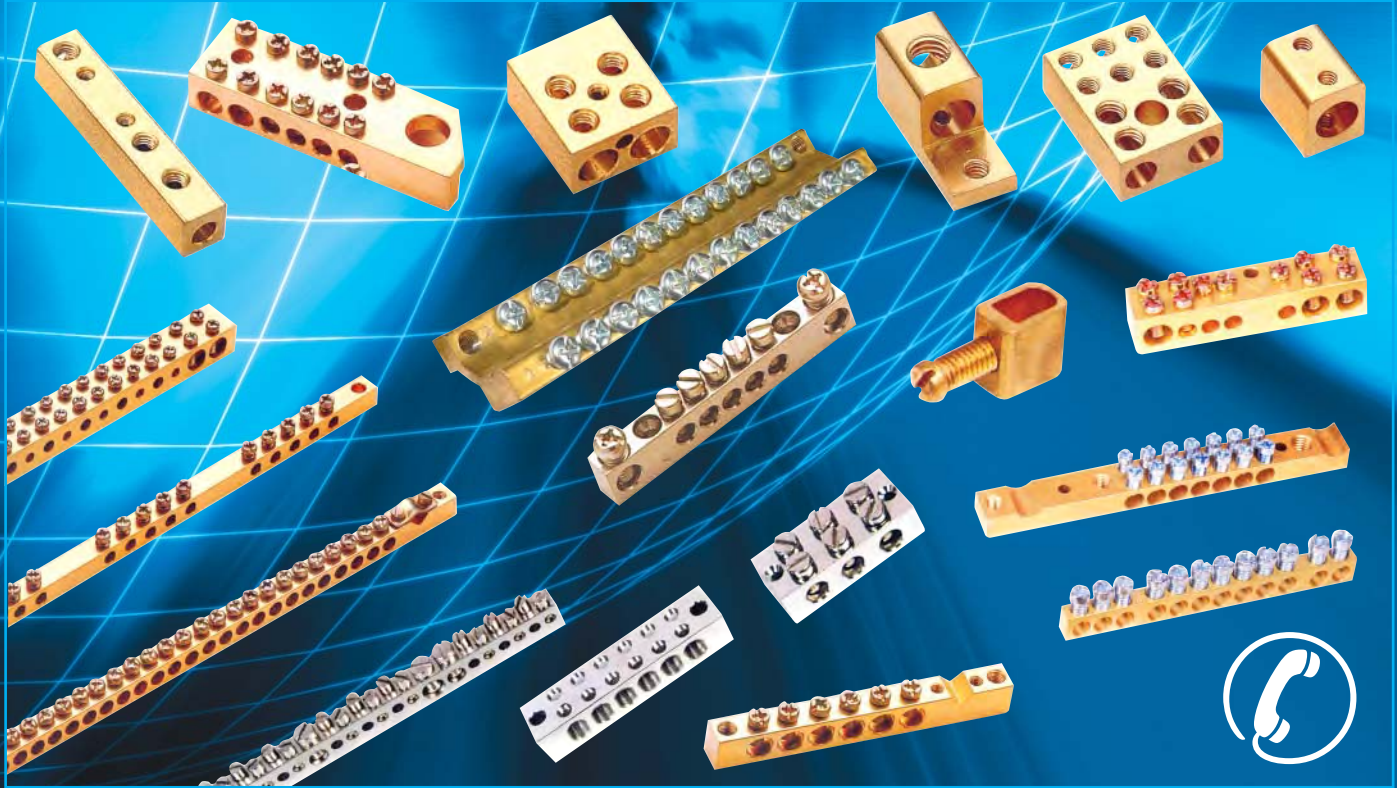

### PANO TOPRAKLAMA KLEMENSLERİ (6.5 x 9 mm KESİT) 80 AMPER

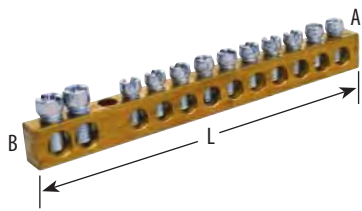

Kablo kesiti max. 10 mm<sup>2</sup>

KOD	cinsi	A	B	L	AD. / ʘ	K. ADEDİ
ONKA - 2001	2/3 = 5 Delikli Pano Top. Klemensi	6,5	9	42	1.65	50
ONKA - 2002	2/5 = 7 Delikli Pano Top. Klemensi	6,5	9	54	2.10	50
ONKA - 2003	2/8 = 10 Delikli Pano Top. Klemensi	6,5	9	73	2.75	50
ONKA - 2004	2/10 = 12 Delikli Pano Top. Klemensi	6,5	9	86	3.15	50
ONKA - 2005	2/13 = 15 Delikli Pano Top. Klemensi	6,5	9	105	3.80	50
ONKA - 2006	2/20 = 22 Delikli Pano Top. Klemensi	6,5	9	148	5.30	50
ONKA - 2007	2/40 = 42 Delikli Pano Top. Klemensi	6,5	9	285	9.90	50
ONKA - 2008	2/60 = 62 Delikli Pano Top. Klemensi	6,5	9	410	14.00	50
ONKA - 2009	2/80 = 82 Delikli Pano Top. Klemensi	6,5	9	535	18.50	50

### PANO TOPRAKLAMA KLEMENSLERİ (7 x 12 mm KESİT) 125 AMPER

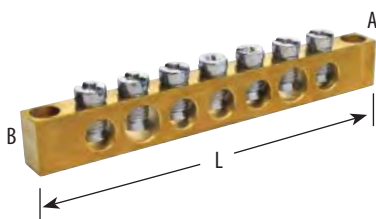

Kablo kesiti max. 25 mm<sup>2</sup>

KOD	cinsi	A	B	L	AD. / ʘ	K. ADEDİ
ONKA - 2021	2/5 = 7 Delikli Pano Top. Klemensi	7	12	69	2.90	50
ONKA - 2022	2/8 = 10 Delikli Pano Top. Klemensi	7	12	93	4.00	50
ONKA - 2023	2/10 = 12 Delikli Pano Top. Klemensi	7	12	119	4.75	50
ONKA - 2024	2/13 = 15 Delikli Pano Top. Klemensi	7	12	133	5.65	50
ONKA - 2025	2/20 = 22 Delikli Pano Top. Klemensi	7	12	188	8.00	50

### PANO TOPRAKLAMA KLEMENSLERİ (10 x 15 mm KESİT) 250 AMPER

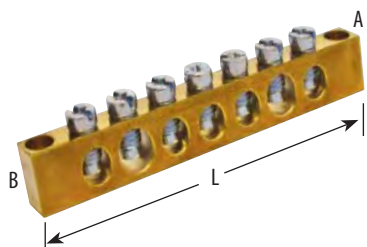

Kablo kesiti max. 50 mm<sup>2</sup>

KOD	cinsi	A	B	L	AD. / ʘ	K. ADEDİ
ONKA - 2041	2/5 = 7 Delikli Pano Top. Klemensi	10	15	124	7.60	50
ONKA - 2042	2/8 = 10 Delikli Pano Top. Klemensi	10	15	149	10.15	50
ONKA - 2043	2/10 = 12 Delikli Pano Top. Klemensi	10	15	173	12.35	50
ONKA - 2044	2/13 = 15 Delikli Pano Top. Klemensi	10	15	211	15.35	50
ONKA - 2045	2/20 = 22 Delikli Pano Top. Klemensi	10	15	308	22.40	50

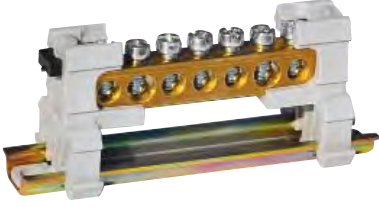

## 1 KUTUPLU DAĞITICI ÜNİTELER (6.5 x 9 mm) 80 AMPER

Kablo kesiti max. 10 mm<sup>2</sup> (Yüksüklü) - 16 mm<sup>2</sup> (Yüksüksüz)

KOD	CİNSİ	L	A	B	C	AD. / Ɔ	K. AD.
ONKA - 2051	2 / 5 7 Delikli	55.5	35.8	40.3	21.2	3.13	32
ONKA - 2052	2 / 8 10 Delikli	74.3	35.8	40.3	21.2	3.83	24
ONKA - 2053	2 / 10 12 Delikli	86.8	35.8	40.3	21.2	4.33	18
ONKA - 2054	2 / 13 15 Delikli	105.5	35.8	40.3	21.2	5.05	16
ONKA - 2055	2 / 20 22 Delikli	149.3	35.8	40.3	21.2	6.77	12

## 1 KUTUPLU DAĞITICI ÜNİTELER (6.5 x 9 mm) 80 AMPER (Kapaklı Sistem)

Kablo kesiti max. 10 mm<sup>2</sup> (Yüksüklü) - 16 mm<sup>2</sup> (Yüksüksüz)

KOD	CİNSİ	L	A	B	C	AD. / Ɔ	K. AD.
ONKA - 2061	2 / 5 7 Delikli	55.5	35.8	40.3	21.2	5.50	32
ONKA - 2062	2 / 8 10 Delikli	74.3	35.8	40.3	21.2	6.79	24
ONKA - 2063	2 / 10 12 Delikli	86.8	35.8	40.3	21.2	7.68	18
ONKA - 2064	2 / 13 15 Delikli	105.5	35.8	40.3	21.2	9.10	16
ONKA - 2065	2 / 20 22 Delikli	149.3	35.8	40.3	21.2	12.10	12

## 1 KUTUPLU DAĞITICI ÜNİTELER (7 x 12 mm) 125 AMPER

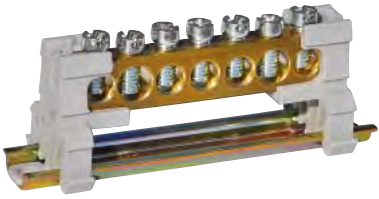
Kablo kesiti max. 25 mm<sup>2</sup> (Yüksüklü) - 35 mm<sup>2</sup> (Yüksüksüz)

KOD	CİNSİ	L	A	B	C	AD. / Ɔ	K. AD.
ONKA - 2056	2 / 5 7 Delikli	68	35.8	40.3	21.2	3.92	32
ONKA - 2057	2 / 8 10 Delikli	91.5	35.8	40.3	21.2	5.05	24
ONKA - 2058	2 / 10 12 Delikli	107	35.8	40.3	21.2	5.80	18
ONKA - 2059	2 / 13 15 Delikli	130	35.8	40.3	21.2	6.70	16
ONKA - 2060	2 / 20 22 Delikli	185	35.8	40.3	21.2	9.10	12

## 1 KUTUPLU DAĞITICI ÜNİTELER (7 x 12 mm) 125 AMPER (Kapaklı Sistem)

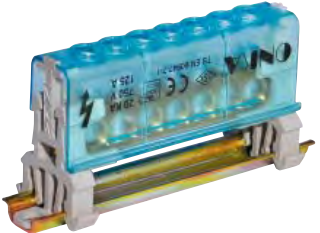
Kablo kesiti max. 25 mm<sup>2</sup> (Yüksüklü) - 35 mm<sup>2</sup> (Yüksüksüz)

KOD	CİNSİ	L	A	B	C	AD. / Ɔ	K. AD.
ONKA - 2071	2 / 5 7 Delikli	68	35.8	40.3	21.2	6.79	32
ONKA - 2072	2 / 8 10 Delikli	91.5	35.8	40.3	21.2	8.73	24
ONKA - 2073	2 / 10 12 Delikli	107	35.8	40.3	21.2	10.05	18
ONKA - 2074	2 / 13 15 Delikli	130	35.8	40.3	21.2	11.75	16
ONKA - 2075	2 / 20 22 Delikli	185	35.8	40.3	21.2	15.90	12

## 1 KUTUPLU DAĞITICI ÜNİTELER (10 x 15 mm) 250 AMPER

Kablo kesiti max. 50 mm<sup>2</sup> (Yüksüklü) - 70 mm<sup>2</sup> (Yüksüksüz)

KOD	CİNSİ	L	A	B	C	AD. / Ɔ	K. AD.
ONKA - 2066	2 / 5 7 Delikli	108	32	38	43	8.75	32
ONKA - 2067	2 / 8 10 Delikli	146	32	38	43	11.30	24
ONKA - 2068	2 / 10 12 Delikli	171	32	38	43	13.55	18
ONKA - 2069	2 / 13 15 Delikli	208	32	38	43	16.55	16
ONKA - 2070	2 / 20 22 Delikli	296	32	38	43	23.55	12

## 1 KUTUPLU DAĞITICI ÜNİTELER (10 x 15 mm) 250 AMPER (Kapaklı Sistem)

Kablo kesiti max. 50 mm<sup>2</sup> (Yüksüklü) - 70 mm<sup>2</sup> (Yüksüksüz)

KOD	CİNSİ	L	A	B	C	AD. / Ɔ	K. AD.
ONKA - 2076	2 / 5 7 Delikli	108	32	38	43	14.90	32
ONKA - 2077	2 / 8 10 Delikli	146	32	38	43	19.35	24
ONKA - 2078	2 / 10 12 Delikli	171	32	38	43	23.15	18
ONKA - 2079	2 / 13 15 Delikli	208	32	38	43	28.15	16
ONKA - 2080	2 / 20 22 Delikli	296	32	38	43	40.10	12

## 2 KUTUPLU DAĞITICI ÜNİTELER (6.5 x 9 mm) 80 AMPER



KOD	CİNSİ	L	A	B	C	AD. / ʘ	K. AD.
ONKA - 2081	2 / 5 7 Delikli	67.5	45.5	52	42	11.00	24
ONKA - 2082	2 / 8 10 Delikli	86.3	45.5	52	42	13.80	20
ONKA - 2083	2 / 10 12 Delikli	98.8	45.5	52	42	15.70	16
ONKA - 2084	2 / 13 15 Delikli	117.5	45.5	52	42	18.80	14
ONKA - 2085	2 / 20 22 Delikli	161.3	45.5	50	42	25.35	8

Kablo kesiti max. 10 mm<sup>2</sup> (Yüksüklü) - 16 mm<sup>2</sup> (Yüksüksüz)

## 2 KUTUPLU DAĞITICI ÜNİTELER (7 x 12 mm) 125 AMPER

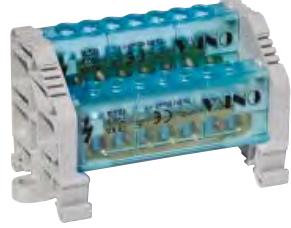

KOD	CİNSİ	L	A	B	C	AD. / ʘ	K. AD.
ONKA - 2091	2 / 5 7 Delikli	80	45.5	52	42	13.50	20
ONKA - 2092	2 / 8 10 Delikli	103.5	45.5	52	42	17.65	16
ONKA - 2093	2 / 10 12 Delikli	119	45.5	52	42	20.45	14
ONKA - 2094	2 / 13 15 Delikli	142	45.5	52	42	24.15	12
ONKA - 2095	2 / 20 22 Delikli	197	45.5	52	42	33.10	8

Kablo kesiti max. 25 mm<sup>2</sup> (Yüksüklü) - 35 mm<sup>2</sup> (Yüksüksüz)

## 3 KUTUPLU DAĞITICI ÜNİTELER (7 x 12 mm) 125 AMPER (Alçak Model)



KOD	CİNSİ	L	A	B	C	AD. / ʘ	K. AD.
ONKA - 2151	2 / 5 7 Delikli	80	45.5	52	42	14.75	12
ONKA - 2152	2 / 8 10 Delikli	103.5	45.5	52	42	19.30	10
ONKA - 2153	2 / 10 12 Delikli	119	45.5	52	42	22.30	10
ONKA - 2154	2 / 13 15 Delikli	142	45.5	52	42	25.75	7
ONKA - 2155	2 / 20 22 Delikli	197	45.5	52	42	35.25	5

Kablo kesiti max. 25 mm<sup>2</sup> (Yüksüklü) - 35 mm<sup>2</sup> (Yüksüksüz)

## 3 KUTUPLU DAĞITICI ÜNİTELER (7 x 12 mm) 125 AMPER (Yüksek Model)

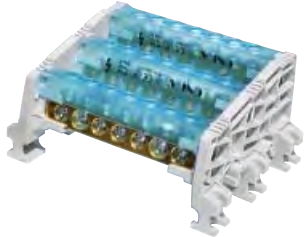

KOD	CİNSİ	L	A	B	C	AD. / ʘ	K. AD.
ONKA - 2171	2 / 5 7 Delikli	80	45.5	52	42	17.75	12
ONKA - 2172	2 / 8 10 Delikli	103.5	45.5	52	42	22.30	10
ONKA - 2173	2 / 10 12 Delikli	119	45.5	52	42	25.30	10
ONKA - 2174	2 / 13 15 Delikli	142	45.5	52	42	28.75	7
ONKA - 2175	2 / 20 22 Delikli	197	45.5	52	42	38.25	5

Kablo kesiti max. 25 mm<sup>2</sup> (Yüksüklü) - 35 mm<sup>2</sup> (Yüksüksüz)

## 3 KUTUPLU DAĞITICI ÜNİTELER (10 x 15 mm) 250 AMPER (Alçak Model)

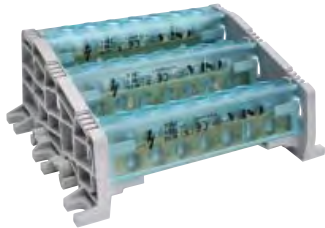

KOD	CİNSİ	L	A	B	C	AD. / ʘ	K. AD.
ONKA - 2181	2 / 5 7 Delikli	117	43.5	50	95	23.90	10
ONKA - 2182	2 / 8 10 Delikli	154.5	43.5	50	95	31.30	7
ONKA - 2183	2 / 10 12 Delikli	179	43.5	50	95	37.75	6
ONKA - 2184	2 / 13 15 Delikli	217	43.5	50	95	46.25	5
ONKA - 2185	2 / 20 22 Delikli	304.5	43.5	50	95	66.00	2

Kablo kesiti max. 50 mm<sup>2</sup> (Yüksüklü) - 70 mm<sup>2</sup> (Yüksüksüz)

## 3 KUTUPLU DAĞITICI ÜNİTELER (10 x 15 mm) 250 AMPER (Yüksek Model)



KOD	CİNSİ	L	A	B	C	AD. / ʘ	K. AD.
ONKA - 2186	2 / 5 7 Delikli	117	43.5	50	95	26.90	10
ONKA - 2187	2 / 8 10 Delikli	154.5	43.5	50	95	34.30	7
ONKA - 2188	2 / 10 12 Delikli	179	43.5	50	95	41.75	6
ONKA - 2189	2 / 13 15 Delikli	217	43.5	50	95	49.25	5
ONKA - 2190	2 / 20 22 Delikli	304.5	43.5	50	95	69.00	2

Kablo kesiti max. 50 mm<sup>2</sup> (Yüksüklü) - 70 mm<sup>2</sup> (Yüksüksüz)

### 4 KUTUPLU DAĞITICI ÜNİTELER (6.5 x 9 mm) 80 AMPER (Alçak Model)

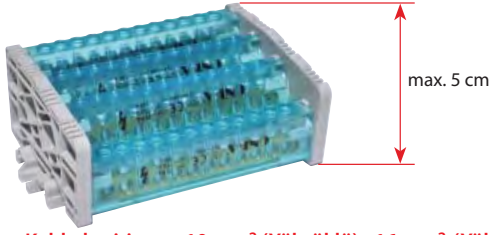

Kablo kesiti max. 10 mm<sup>2</sup> (Yüksüklü) - 16 mm<sup>2</sup> (Yüksüksüz)

KOD	CİNSİ	L	A	B	C	AD. / ƒ	K. AD.
ONKA - 2201	2 / 5 7 Delikli	80	77.2	83.8	87.2	14.00	12
ONKA - 2202	2 / 8 10 Delikli	103.5	77.2	83.8	87.2	18.35	10
ONKA - 2203	2 / 10 12 Delikli	119	77.2	83.8	87.2	21.25	10
ONKA - 2204	2 / 13 15 Delikli	142	77.2	83.8	87.2	26.00	7
ONKA - 2205	2 / 20 22 Delikli	197	77.2	83.8	87.2	36.25	5

### 4 KUTUPLU DAĞITICI ÜNİTELER (7 x 12 mm) 125 AMPER (Alçak Model)

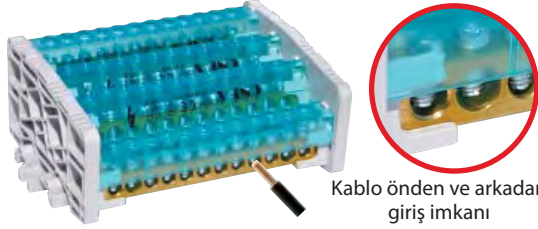

Kablo kesiti max. 25 mm<sup>2</sup> (Yüksüklü) - 35 mm<sup>2</sup> (Yüksüksüz)

KOD	CİNSİ	L	A	B	C	AD. / ƒ	K. AD.
ONKA - 2211	2 / 5 7 Delikli	80	77.2	83.8	87.2	18.45	12
ONKA - 2212	2 / 8 10 Delikli	103.5	77.2	83.8	87.2	25.00	10
ONKA - 2213	2 / 10 12 Delikli	119	77.2	83.8	87.2	29.45	10
ONKA - 2214	2 / 13 15 Delikli	142	77.2	83.8	87.2	35.25	7
ONKA - 2215	2 / 20 22 Delikli	197	77.2	83.8	87.2	49.40	5

### 4 KUTUPLU DAĞITICI ÜNİTELER (6.5 x 9 mm) 80 AMPER (Yüksek Model)



Kablo kesiti max.  
10 mm<sup>2</sup> (Yüksüklü)  
16 mm<sup>2</sup> (Yüksüksüz)

KOD	CİNSİ	L	A	B	C	AD. / ƒ	K. AD.
ONKA - 2101	2 / 5 7 Delikli	80	77.2	83.8	87.2	20.10	8
ONKA - 2102	2 / 8 10 Delikli	103.5	77.2	83.8	87.2	26.00	6
ONKA - 2103	2 / 10 12 Delikli	119	77.2	83.8	87.2	30.00	6
ONKA - 2104	2 / 13 15 Delikli	142	77.2	83.8	87.2	36.60	4
ONKA - 2105	2 / 20 22 Delikli	197	77.2	83.8	87.2	50.50	3

### 4 KUTUPLU DAĞITICI ÜNİTELER (7 x 12 mm) 125 AMPER (Yüksek Model)

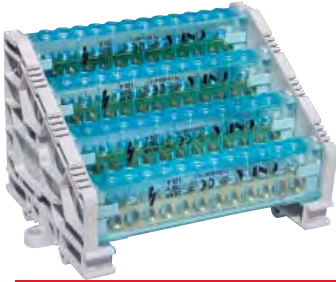

Kablo kesiti max.  
25 mm<sup>2</sup> (Yüksüklü)  
35 mm<sup>2</sup> (Yüksüksüz)

KOD	CİNSİ	L	A	B	C	AD. / ƒ	K. AD.
ONKA - 2111	2 / 5 7 Delikli	80	77.2	83.8	87.2	22.45	8
ONKA - 2112	2 / 8 10 Delikli	103.5	77.2	83.8	87.2	30.25	6
ONKA - 2113	2 / 10 12 Delikli	119	77.2	83.8	87.2	35.45	6
ONKA - 2114	2 / 13 15 Delikli	142	77.2	83.8	87.2	42.35	4
ONKA - 2115	2 / 20 22 Delikli	197	77.2	83.8	87.2	59.00	3

### 5 KUTUPLU DAĞITICI ÜNİTELER (10 x 15 mm) 250 AMPER

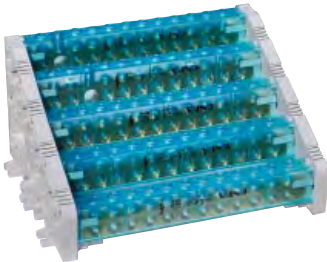

Kablo kesiti max.  
50 mm<sup>2</sup> (Yüksüklü)  
70 mm<sup>2</sup> (Yüksüksüz)

KOD	CİNSİ	L	A	B	C	AD. / ƒ	K. AD.
ONKA - 2191	2 / 5 7 Delikli	124.5	90	96	150	40.25	1
ONKA - 2192	2 / 8 10 Delikli	162	90	96	150	52.40	1
ONKA - 2193	2 / 10 12 Delikli	187	90	96	150	62.75	1
ONKA - 2194	2 / 13 15 Delikli	224.5	90	96	150	76.50	1
ONKA - 2195	2 / 20 22 Delikli	312	90	96	150	109.00	1

### 5 KUTUPLU DAĞITICI ÜNİTELER (10 x 15 mm) 250 AMPER (YÜKSEK MODEL)

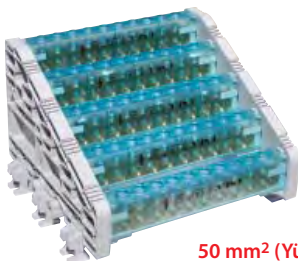

Kablo kesiti max.  
50 mm<sup>2</sup> (Yüksüklü) - 70 mm<sup>2</sup> (Yüksüksüz)

KOD	CİNSİ	L	A	B	C	AD. / ƒ	K. AD.
ONKA - 2216	2 / 5 7 Delikli	124.5	90	96	150	43.25	1
ONKA - 2217	2 / 8 10 Delikli	162	90	96	150	55.40	1
ONKA - 2218	2 / 10 12 Delikli	187	90	96	150	65.75	1
ONKA - 2219	2 / 13 15 Delikli	224.5	90	96	150	79.50	1
ONKA - 2220	2 / 20 22 Delikli	312	90	96	150	112.00	1

## 5 KADEMELİ BARALI DAĞITICI ÜNİTE (10 x 15 mm) 250 AMPER

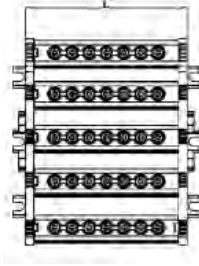
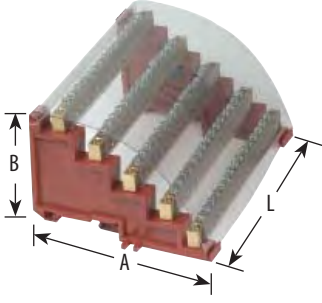
Kablo kesiti max. 50 mm<sup>2</sup>

KOD	CİNSİ	L	A	B	AD. / ʘ	K. AD.
ONKA - 2121	2 / 5 7 Delikli	124.5	90	96	45.00	1
ONKA - 2122	2 / 8 10 Delikli	162	90	96	57.00	1
ONKA - 2123	2 / 10 12 Delikli	187	90	96	67.00	1
ONKA - 2124	2 / 13 15 Delikli	224.5	90	96	81.00	1
ONKA - 2125	2 / 20 22 Delikli	312	90	96	113.00	1

## 5 KADEMELİ 30 x 5 BAKIR BARALI DAĞITICI ÜNİTE

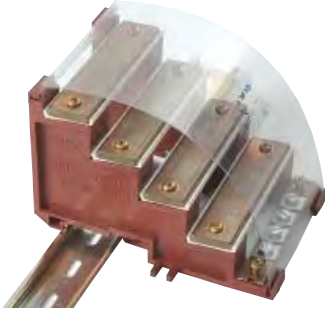

30 x 5 bakır bara yatağı

KOD	CİNSİ	AD. / ʘ	K. AD.
ONKA-2135	Max. 30 x 5 Bakır Baralı istenilen uzunlukta üretilir.	ʘ	1

## 5 KADEMELİ 30 x 5 BAKIR BARA DAĞITICI ÜNİTELER VE AKSESUARI



KOD	CİNSİ	AD. / ʘ	K. AD.
ONKA-2131	5 Katlı Dağıtıcı Ünite (Max. 30x5) Yatak	12.50	10
ONKA-2132	İzasyon Separatörü	ʘ	1 mt.
ONKA-2133	Üst İzasyon Kapak	ʘ	1

## DAĞITICI ÜNİTE YÜKSELTİCİ AYAKLARI



KOD	CİNSİ	AD. / ʘ	K. AD.
ONKA-2134	1 - 3 - 5'li dağıtıcı üniteler için yükseltme ayakları	0.50	100

## DAĞITICI ÜNİTE AKSESUAR SEÇENEKLERİ



CİNSİ	AD. / ʘ
Ünite Kutupları Renk Seçenekleri	ʘ
Ünite Kutup İzasyon Tapaları	ʘ

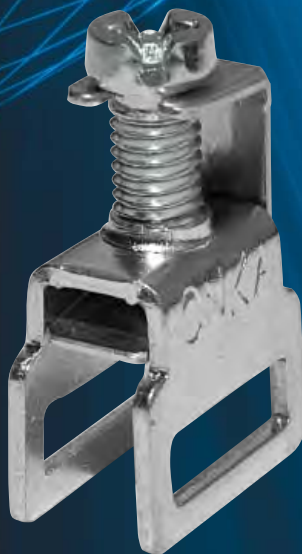

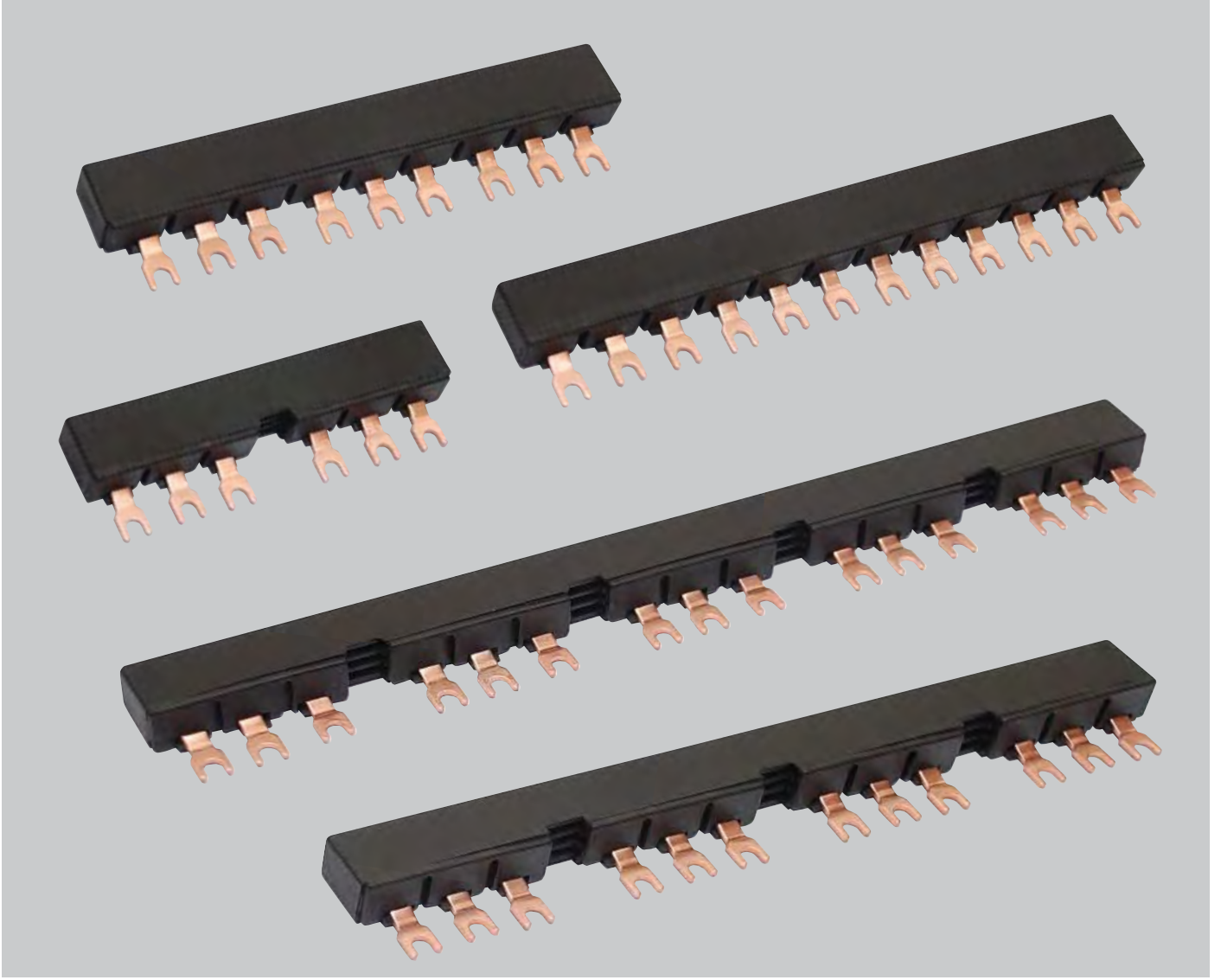

### İZOLASYONLU MOTOR KORUMA BARALARI

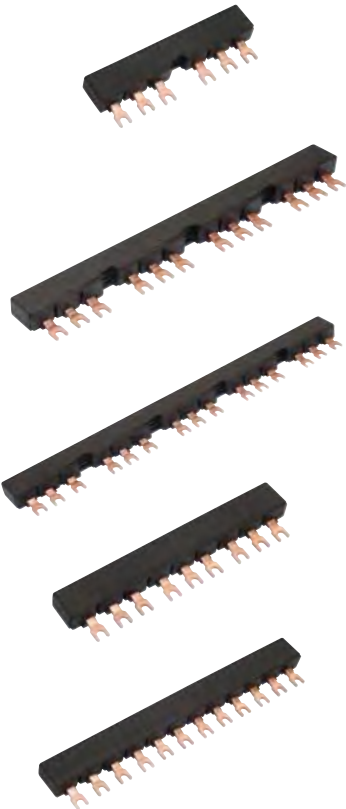

KOD	CİNSİ	AD. / ʈ	K. AD.
ONKA-MSVG54-14-2	Motor Koruma Barası, İkili Modül, Adım Genişliği 45 + 9 = 54 mm	16.50	1

KOD	CİNSİ	AD. / ʈ	K. AD.
ONKA-MSVG54-14-4	Motor Koruma Barası, Dörtlü Modül, Adım Genişliği 45 + 9 = 54 mm	19.00	1

KOD	CİNSİ	AD. / ʈ	K. AD.
ONKA-MSVG54-14-5	Motor Koruma Barası, Beşli Modül, Adım Genişliği 45 + 9 = 54 mm	24.00	1

KOD	CİNSİ	AD. / ʈ	K. AD.
ONKA-MSVG45-14-3	Motor Koruma Barası, Üçlü Mod, boşluk yok, Adım Gen. 45 mm	16.25	1

KOD	CİNSİ	AD. / ʈ	K. AD.
ONKA-MSVG45-14-4	Motor Koruma Barası, Dörtlü Mod, boşluk yok, Adım Gen. 45 mm	19.25	1

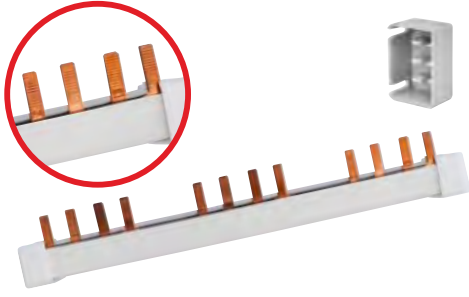

### 3 FAZ + NÖTR MÜŞTEREK W OTOMAT BARALARI (İĞNE TİP)

KOD	1.5 mm 80 A AD. / ʘ	KOD	2 mm 100 A AD. / ʘ	MODÜL AD.	K. AD.
ONKA-3058	27.00	ONKA-3072	36.00	4	16
ONKA-3059	54.00	ONKA-3073	72.00	8	16
ONKA-3060	94.00	ONKA-3074	125.00	14	16
ONKA-3057	0.15	3 Faz + Nötr Müşterek W Oto. Barası Yan Kapak			100



### TRIFAZE MÜŞTEREK W OTOMAT BARALARI (İĞNE TİP)

KOD	1 mm 63 A AD. / ʘ	KOD	1.5 mm 80 A AD. / ʘ	KOD	2 mm 100 A AD. / ʘ	MODÜL AD.	K. AD.
ONKA-3041	10.45	ONKA-3051	14.25	ONKA-3066	19.00	4	30
ONKA-3042	15.50	ONKA-3052	21.15	ONKA-3067	28.00	6	30
ONKA-3043	20.55	ONKA-3053	28.15	ONKA-3068	37.50	8	30
ONKA-3044	25.60	ONKA-3054	35.00	ONKA-3069	46.50	10	30
ONKA-3045	42.00	ONKA-3055	69.00	ONKA-3070	92.00	20 (1 m)	25
ONKA-3056	0.10	Trifaze Bara Yan Kapak					100

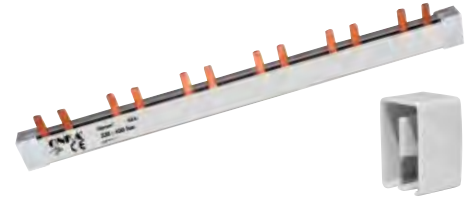

### 2 FAZLI MÜŞTEREK W OTOMAT BARALARI

KOD	1 mm 63 A AD. / ʘ	KOD	1.5 mm 80 A AD. / ʘ	CİNSİ	MODÜL AD.	K. AD.
ONKA - 3021	7.45	ONKA - 3031	9.75	İğne Tip	6	30
ONKA - 3022	11.00	ONKA - 3032	14.45	İğne Tip	9	30
ONKA - 3023	14.55	ONKA - 3033	19.15	İğne Tip	12	30
ONKA - 3024	18.10	ONKA - 3034	23.85	İğne Tip	15	30
ONKA - 3025	33.50	ONKA - 3035	44.25	İğne Tip	28	30
ONKA - 3026	0.09	İki Fazlı Müşterek W Otomat Barası Yan Kapak				100

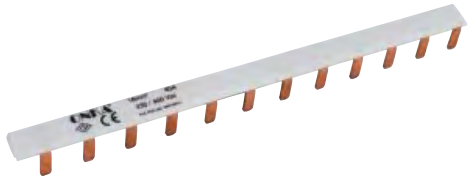

### MONOFAZE MÜŞTEREK W OTOMAT BARALARI

KOD	1.5 mm 80 A AD. / ʘ	KOD	2 mm 100 A AD. / ʘ	CİNSİ	MODÜL AD.	K. AD.
ONKA - 3001	5.25	ONKA - 3011	7.00	İğne Tip	12	50
ONKA - 3002	7.70	ONKA - 3012	10.30	İğne Tip	18	50
ONKA - 3003	10.15	ONKA - 3013	13.65	İğne Tip	24	50
ONKA - 3004	12.60	ONKA - 3014	16.95	İğne Tip	30	50
ONKA - 3005	23.25	ONKA - 3015	31.30	İğne Tip	56 (1 m)	50

### MODÜLER GÜÇ KLEMENSLERİ (Trifaze-Monofaze-Difaze Bağlantı Klemensi)

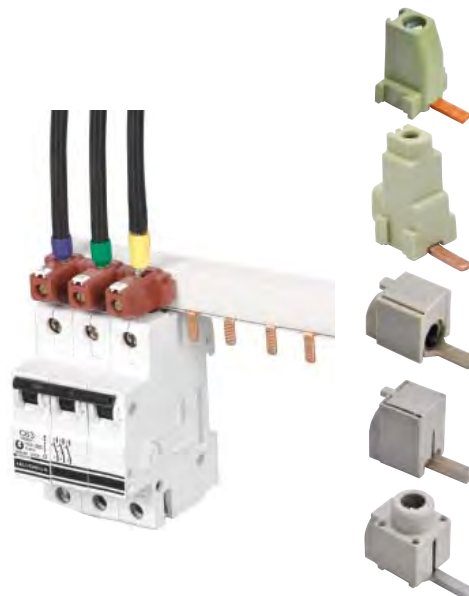

KOD	CİNSİ	AD. / ʘ	K. AD.
ONKA-3061	No.1 (2.5 - 10 mm <sup>2</sup> )	0.78	150
ONKA-3065	No.2 (16 - 25 mm <sup>2</sup> )	1.35	100
POLL-2010201	No.2 (6 - 25 mm <sup>2</sup> )	3.50	30
POLL-2010235	No.3 (6 - 50 mm <sup>2</sup> )	7.25	25
FTG-802/215 S	No.3 (6 - 50 mm <sup>2</sup> )	5.50	25

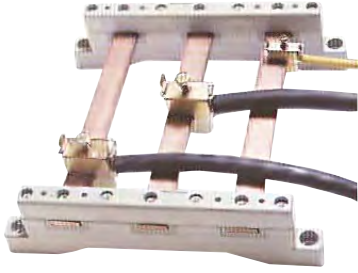

### BAKIR BARA BAĞLANTI KLEMENSİ (YAY BASKILI) 16 mm<sup>2</sup>

KOD	CİNSİ	AD. / ʈ	K. AD.
ONKA-2140	SK16 F5 Bakır Bara Klemensi 1.5 - 16 mm <sup>2</sup>	2.10	100
ONKA-2141	SK16F10 Bakır Bara Klemensi 1.5 - 16 mm <sup>2</sup>	2.31	100



### BAKIR BARA BAĞLANTI KLEMENSİ (YAY BASKILI) 35 mm<sup>2</sup>

KOD	CİNSİ	AD. / ʈ	K. AD.
ONKA-2142	SK35 F5 Bakır Bara Klemensi 1.5 - 35 mm <sup>2</sup>	3.64	50
ONKA-2143	SK35F10 Bakır Bara Klemensi 1.5 - 35 mm <sup>2</sup>	4.04	50



### BAKIR BARA BAĞLANTI KLEMENSİ (YAY BASKILI) 70 mm<sup>2</sup>

KOD	CİNSİ	AD. / ʈ	K. AD.
ONKA-2144	SK70 F5 Bakır Bara Klemensi 16 - 70 mm <sup>2</sup>	5.00	25
ONKA-2145	SK70F10 Bakır Bara Klemensi 16 - 70 mm <sup>2</sup>	6.00	25



### BAKIR BARA BAĞLANTI KLEMENSİ (YAY BASKILI) 120 mm<sup>2</sup>

KOD	CİNSİ	AD. / ʈ	K. AD.
ONKA-2146	SK120 F5 Bakır Bara Klemensi 16 - 120 mm <sup>2</sup>	8.50	25
ONKA-2147	SK120F10 Bakır Bara Klemensi 16 - 120 mm <sup>2</sup>	9.00	25

### BAKIR BARA BAĞLANTI KLEMENSLERİ

KOD	CİNSİ	AD. / ʈ	K. AD.
ONKA-2165	25 x 5 Bakır Bara Klemensi 1.5 - 6 mm <sup>2</sup>	3.00	100
ONKA-2166	30 x 5 Bakır Bara Klemensi 6 - 35 mm <sup>2</sup>	3.50	100
ONKA-2167	30 x 10 Bakır Bara Klemensi 6 - 35 mm <sup>2</sup>	4.00	100
ONKA-2168	40 x 5 Bakır Bara Klemensi 6 - 35 mm <sup>2</sup>	4.50	100
ONKA-2169	40 x 10 Bakır Bara Klemensi 6 - 35 mm <sup>2</sup>	5.00	100



### GEÇMELİ BAKIR BARA BAĞLANTI KLEMENSLERİ (PALETLİ SİSTEM)

KOD	CİNSİ	AD. / ʈ	K. AD.
ONKA-2160	SK12 F3 Bakır Bara Klemensi 16 mm <sup>2</sup>	0.97	300
ONKA-2161	SK12 F3 Bakır Bara Klemensi 35 mm <sup>2</sup>	1.20	250
ONKA-2162	12 x 3 mm Elektrolitik Bakır Bara 1 mt.	25.00	1 mt.



### (NÖTR) VİDALI TOPRAKLAMA BARALARI

KOD	CİNSİ	AD. / ʈ	KOD	AD. / ʈ	KOD	AD. / ʈ	K. AD.
ONKA-3075	31 Vida	23.40	ONKA-3080	29.25	ONKA-3088	40.60	25
ONKA-3076	62 Vida	26.10	ONKA-3087	32.00	ONKA-3086	43.50	25



### (NÖTR) VİDALI TOPRAKLAMA BARA MESNEDİ

KOD	CİNSİ	AD. / ʈ	K. AD.
ONKA-3091	Kumanda Bara Mesnedi	0.75	100





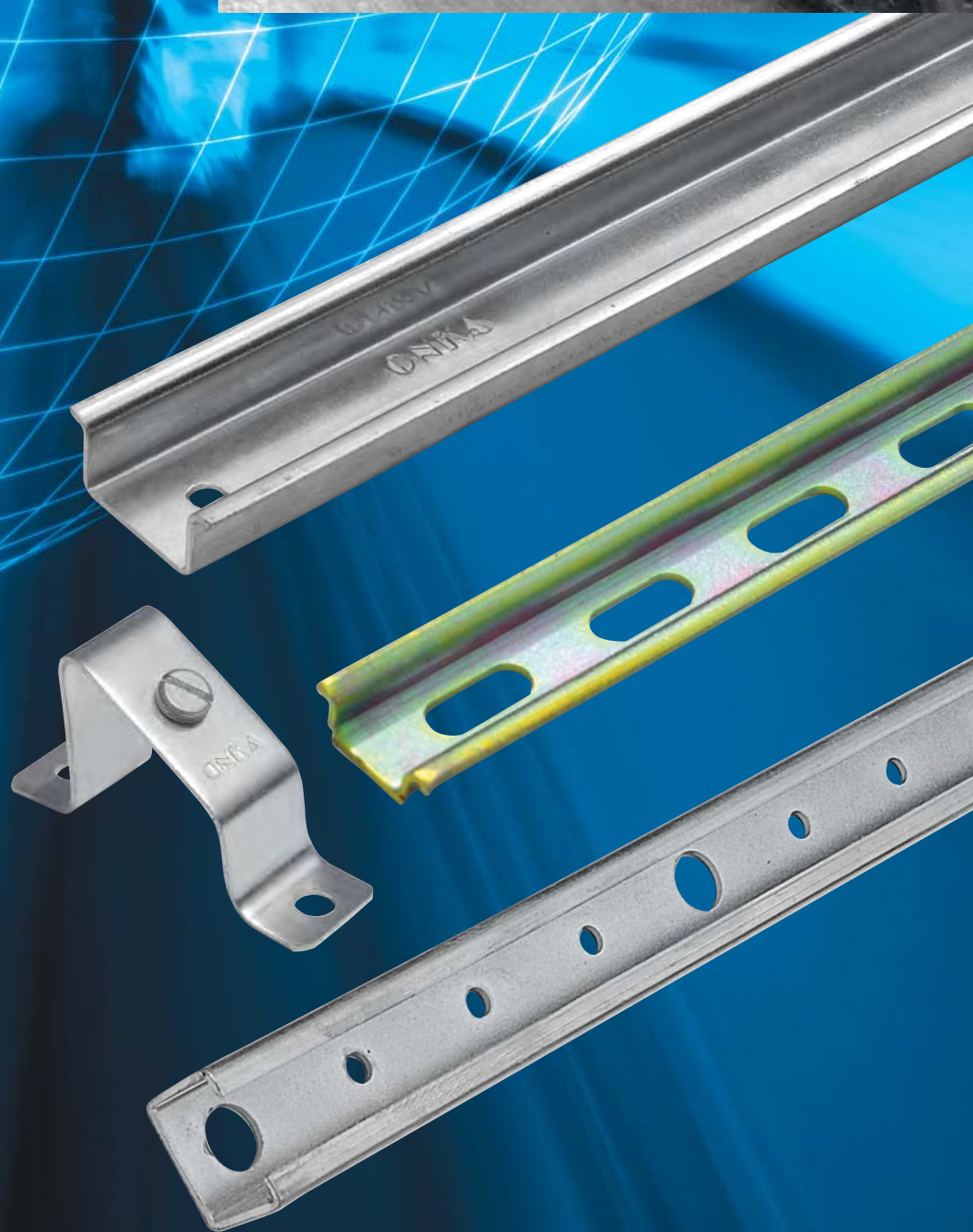
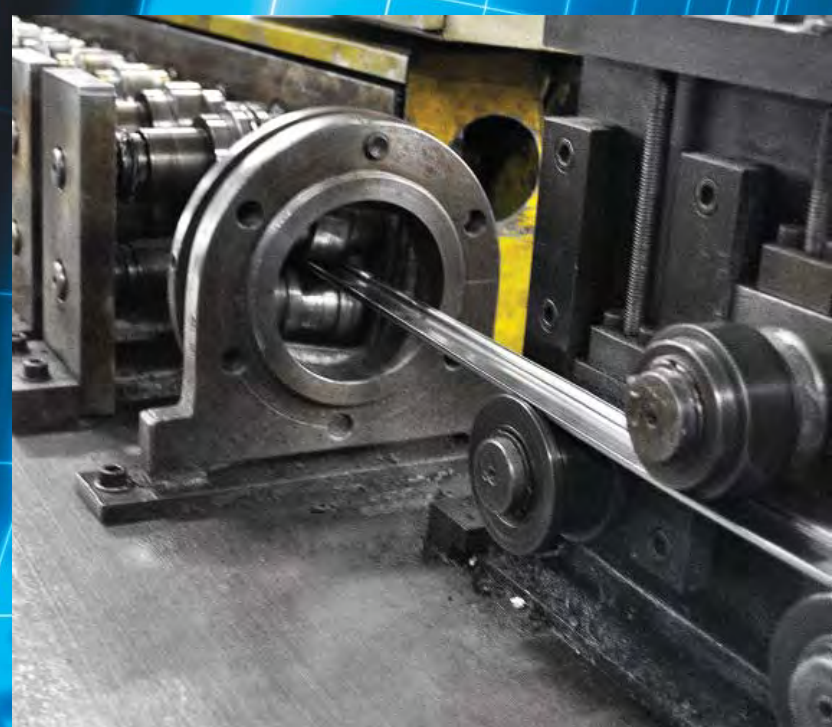



**0 FİRE + 0 KOROZYON + 0 İŞÇİLİK = MALİYET KAZANCI**

İSTENİLEN  
ÖLÇÜDE KESİM  
FİREDE KAZANÇ

KESİMDEN SONRA  
KAPLAMA  
KALİTEDE KAZANÇ

ZAMAN  
KAYBINDAN  
KAZANÇ

CM FİYATI



### 35 x 7,5 DÜZ SAC MONTAJ RAYLARI (CR 3 ve CR 6 KAP.)



KOD CR + 3	KOD CR + 6	CİNSİ	AD. / ʘ	K. AD.
ONKA-4021	ONKA-4001	30 cm	1.60	100
ONKA-4022	ONKA-4002	1 m	4.70	50
ONKA-4023	ONKA-4003	2 m	9.50	50
ONKA-4024	ONKA-4004	3 m	14.00	25

### 35 x 7,5 DELİKLİ SAC MONTAJ RAYLARI (CR 3 ve CR 6 KAP.)



KOD CR + 3	KOD CR + 6	CİNSİ	AD. / ʘ	K. AD.
ONKA-4031	ONKA-4011	30 cm	1.90	100
ONKA-4032	ONKA-4012	1 m	5.00	50
ONKA-4033	ONKA-4013	2 m	10.00	50
ONKA-4034	ONKA-4014	3 m	15.00	25

### 35 x 15 DÜZ SAC MONTAJ RAYLARI (CR 3 ve CR 6 KAP.)



KOD CR + 3	KOD CR + 6	CİNSİ	AD. / ʘ	K. AD.
ONKA-4061	ONKA-4041	30 cm	3.00	100
ONKA-4062	ONKA-4042	1 m	9.00	25
ONKA-4063	ONKA-4043	2 m	18.00	25
ONKA-4064	ONKA-4044	3 m	27.00	25

### 35 x 15 DELİKLİ SAC MONTAJ RAYLARI (CR 3 ve CR 6 KAP.)



KOD CR + 3	KOD CR + 6	CİNSİ	AD. / ʘ	K. AD.
ONKA-4071	ONKA-4051	30 cm	3.50	100
ONKA-4072	ONKA-4052	1 m	9.50	25
ONKA-4073	ONKA-4053	2 m	19.00	25
ONKA-4074	ONKA-4054	3 m	28.50	25

### 15 x 5,5 DÜZ SAC MONTAJ RAYLARI (CR 3 ve CR 6 KAP.)



KOD CR + 3	KOD CR + 6	CİNSİ	AD. / ʘ	K. AD.
ONKA-4101	ONKA-4081	30 cm	0.95	100
ONKA-4102	ONKA-4082	1 m	2.30	100
ONKA-4103	ONKA-4083	2 m	4.60	100
ONKA-4104	ONKA-4084	3 m	6.90	100

### 15 x 5,5 DELİKLİ SAC MONTAJ RAYLARI (CR 3 ve CR 6 KAP.)



KOD CR + 3	KOD CR + 6	CİNSİ	AD. / ʘ	K. AD.
ONKA - 4111	ONKA-4091	30 cm	1.25	100
ONKA - 4112	ONKA-4092	1 m	2.60	100
ONKA - 4113	ONKA-4093	2 m	5.20	100
ONKA - 4114	ONKA-4094	3 m	7.80	100

### DÜZ ALÜMİNYUM MONTAJ RAYLARI



KOD	CİNSİ	AD. / ʘ	K. AD.
ONKA - 4121	30 cm	3.00	100
ONKA - 4122	1 m	8.50	35
ONKA - 4123	2 m	17.00	25
ONKA - 4124	3 m	25.00	100

### DELİKLİ ALÜMİNYUM MONTAJ RAYLARI



KOD	CİNSİ	AD. / ʘ	K. AD.
ONKA - 4131	30 cm	3.25	100
ONKA - 4132	1 m	8.75	35
ONKA - 4133	2 m	17.50	25
ONKA - 4134	3 m	26.00	100

### MG TİPİ DÜZ ALÜMİNYUM MONTAJ RAYLARI



KOD	CİNSİ	AD. / ʘ	K. AD.
ONKA - 4141	30 cm	4.50	25
ONKA - 4142	1 m	14.00	50
ONKA - 4143	2 m	28.00	50
ONKA - 4144	3 m	42.00	50

### MG TİPİ DELİKLİ ALÜMİNYUM MONTAJ RAYLARI



KOD	CİNSİ	AD. / ʘ	K. AD.
ONKA - 4146	30 cm	5.00	25
ONKA - 4147	1 m	14.50	50
ONKA - 4148	2 m	29.00	50
ONKA - 4149	3 m	43.50	50

## RAY TAŞIYICILAR ( SAC CR + 3 )



KOD	CİNSİ	AD./ ʘ	K. AD.
ONKA - 4172	Ray Taşıyıcı Sac Krom	0.70	100

## RAY TAŞIYICILAR ( SAC CR + 6 )



KOD	CİNSİ	AD./ ʘ	K. AD.
ONKA - 4171	Ray Taşıyıcı Sac Nikel	0.70	100

## RAY TAŞIYICILAR ALÜMİNYUM



KOD	CİNSİ	AD./ ʘ	K. AD.
ONKA - 4161	Ray Taşıyıcı Alüminyum	0.95	100

## RAY TAŞIYICILAR ALÜMİNYUM (Yüksek Tip)

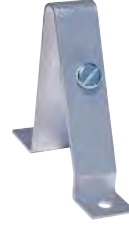

KOD	CİNSİ	AD./ ʘ	K. AD.
ONKA - 4162	Ray Taşıyıcı Sac Nikel	1.10	60



## U PROFİL DESTEK RAYI ve KÖŞE APARATI (PANO KAPAKLARI İÇİN)

KOD	CİNSİ	AD. / TL	K. AD.
ONKA- 4191	1 Metre U Profil	ʘ	50
ONKA- 4192	2 Metre U Profil	ʘ	50
ONKA- 4193	3 Metre U Profil	ʘ	50
ONKA- 4195	Sağ Sol Köşe Aparatı	ʘ	100

## MG TİP CİHAZ BAĞLAMA APARATI



KOD	CİNSİ	CİVATA	AD./ ʘ	K. AD.
ONKA - 4151	MG Tip Cihaz Bağlama Aparatı Kompak Şalterler için	M4	0.40	250
ONKA - 4152	MG Tip Cihaz Bağlama Aparatı Kompak Şalterler için	M5	0.40	250
ONKA - 4153	MG Tip Cihaz Bağlama Aparatı Kompak Şalterler için	M6	0.40	250
ONKA - 4154	MG Tip Cihaz Bağlama Aparatı Kompak Şalterler için	M8	0.40	250



## W OTOMAT RAYI KLİPSLERİ

KOD	CİNSİ	AD. / ʘ	K. AD.
ONKA - 4175	M4 - M5	ʘ	100



## METAL RAY YÜKSELTME APARATI

KOD	CİNSİ	AD. / ʘ	K. AD.
ONKA- 4180	Metrik ve Uzunluk istenilen ölçüde	ʘ	100

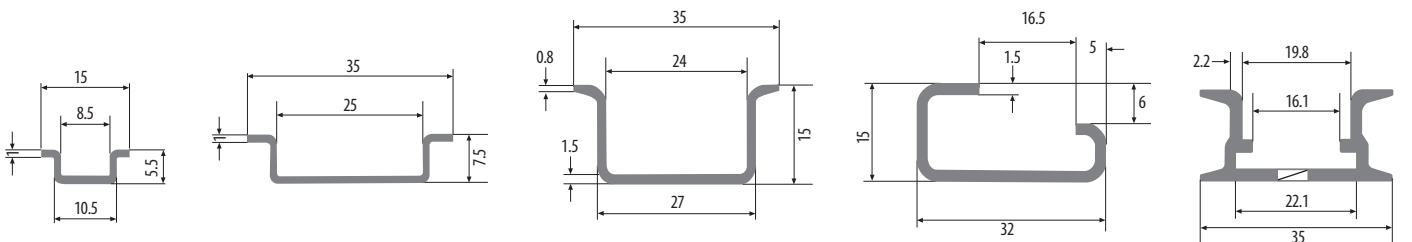

Bütün Ürünler 'a uyumlu CR-3 olarak kaplanabilir.



## DIN NORMU 46235 TİP SKP SIKMALI KABLO PAPUÇLARI (BAKIR)

KOD	REF. NO	KABLO KESİTİ mm <sup>2</sup>	MET.	ØE	Øİ	L	ØT	A	L1	C	AĞIR. (gr)	AD./ç	K. AD.
ONKA-6050	DSKP-6-5	6	M5	5.5	4	33.5	5.3	8.5	13	6	2,254	0.44	1000
ONKA-6051	DSKP-6-6	6	M6	5.5	4	33.5	6.4	8.5	13	6	2,254	0.44	1000
ONKA-6052	DSKP-10-5	10	M5	6.5	5	37.5	5.3	10	14	6.5	3,714	0.62	800
ONKA-6053	DSKP-10-6	10	M6	6.5	5	37.5	6.4	10	14	6.5	3,714	0.62	800
ONKA-6054	DSKP-16-6	16	M6	8.5	6	49	6.4	13	15	7.5	3,741	1.26	300
ONKA-6055	DSKP-16-8	16	M8	8.5	6	49	8.4	13	15	7.5	3,741	1.26	300
ONKA-6056	DSKP-16-10	16	M10	8.5	6	49	10.5	13	15	7.5	3,741	1.26	300
ONKA-6057	DSKP-25-6	25	M6	10	7.5	51	6.4	14.5	16.5	9	4,191	1.72	250
ONKA-6058	DSKP-25-8	25	M10	10	7.5	51	8.4	14.5	16.5	9	4,191	1.72	250
ONKA-6059	DSKP-25-10	25	M12	10	7.5	51	10.5	14.5	16.5	9	4,191	1.72	250
ONKA-6060	DSKP-35-6	35	M14	12.5	8.5	57	6.4	17.5	20.5	10	3,867	2.51	150
ONKA-6061	DSKP-35-8	35	M8	12.5	8.5	57	8.4	17.5	20.5	10	3,867	2.51	150
ONKA-6062	DSKP-35-10	35	M10	12.5	8.5	57	10.5	17.5	20.5	10	3,867	2.51	150
ONKA-6063	DSKP-35-12	35	M12	12.5	8.5	57	12.5	17.5	20.5	10	3,867	2.51	150
ONKA-6064	DSKP-50-8	50	M8	14.5	10	67	8.4	20.5	23	11	4,299	4.90	100
ONKA-6065	DSKP-50-10	50	M8	14.5	10	67	10.5	20.5	23	11	4,299	4.90	100
ONKA-6066	DSKP-50-12	50	M10	14.5	10	67	12.5	20.5	23	11	4,299	4.90	100
ONKA-6067	DSKP-50-14	50	M12	14.5	10	67	15	20.5	23	11	4,299	4.90	100
ONKA-6068	DSKP-70-8	70	M8	16.5	12	70	8.4	23.5	26	12.5	4,313	5.98	75
ONKA-6069	DSKP-70-10	70	M10	16.5	12	70	10.5	23.5	26	12.5	4,313	5.98	75
ONKA-6070	DSKP-70-12	70	M12	16.5	12	70	12.5	23.5	26	12.5	4,313	5.98	75
ONKA-6071	DSKP-70-14	70	M14	16.5	12	70	15	23.5	26	12.5	4,313	5.98	75
ONKA-6072	DSKP-70-16	70	M16	16.5	12	70	17	23.5	26	12.5	4,313	5.98	75
ONKA-6073	DSKP-95-8	95	M8	19	13.5	81	8.4	27.5	28	13.5	3,885	9.66	40
ONKA-6074	DSKP-95-10	95	M10	19	13.5	81	10.5	27.5	28	13.5	3,885	9.66	40
ONKA-6075	DSKP-95-12	95	M12	19	13.5	81	12.5	27.5	28	13.5	3,885	9.66	40
ONKA-6076	DSKP-95-14	95	M14	19	13.5	81	15	27.5	28	13.5	3,885	9.66	40
ONKA-6077	DSKP-95-16	95	M16	19	13.5	81	17	27.5	28	13.5	3,885	9.66	40
ONKA-6078	DSKP-120-10	120	M10	21	15.5	86	10.5	30	33	13.5	4,207	12.40	40
ONKA-6079	DSKP-120-12	120	M12	21	15.5	86	12.5	30	33	13.5	4,207	12.40	40
ONKA-6080	DSKP-120-14	120	M14	21	15.5	86	15	30	33	13.5	4,207	12.40	40
ONKA-6081	DSKP-120-16	120	M16	21	15.5	86	17	30	33	13.5	4,207	12.40	40
ONKA-6082	DSKP-120-20	120	M20	21	15.5	86	21	30	33	13.5	4,207	12.40	40
ONKA-6083	DSKP-150-10	150	M10	23	17	97	10.5	32.5	35.5	18	3,741	17.75	25
ONKA-6084	DSKP-150-12	150	M12	23	17	97	12.5	32.5	35.5	18	3,741	17.75	25
ONKA-6085	DSKP-150-14	150	M14	23	17	97	15	32.5	35.5	18	3,741	17.75	25
ONKA-6086	DSKP-150-16	150	M16	23	17	97	17	32.5	35.5	18	3,741	17.75	25
ONKA-6087	DSKP-150-20	150	M20	23	17	97	21	32.5	35.5	18	3,741	17.75	25
ONKA-6088	DSKP-185-10	185	M10	25.5	18	101	10.5	36	39	19	2,678	20.25	20
ONKA-6089	DSKP-185-12	185	M12	25.5	18	101	12.5	36	39	19	2,678	20.25	20
ONKA-6090	DSKP-185-14	185	M14	25.5	18	101	15	36	39	19	2,678	20.25	20
ONKA-6091	DSKP-185-16	185	M16	25.5	18	101	17	36	39	19	2,678	20.25	20
ONKA-6092	DSKP-185-20	185	M20	25.5	18	101	21	36	39	19	2,678	20.25	20
ONKA-6093	DSKP-240-10	240	M10	28	22	111	10.5	40	41	19	3,062	24.60	15
ONKA-6094	DSKP-240-12	240	M12	28	22	111	12.5	40	41	19	3,062	24.60	15
ONKA-6095	DSKP-240-14	240	M14	28	22	111	15	40	41	19	3,062	24.60	15
ONKA-6096	DSKP-240-16	240	M16	28	22	111	17	40	41	19	3,062	24.60	15
ONKA-6097	DSKP-240-20	240	M20	28	22	111	21	40	41	19	3,062	24.60	15
ONKA-6098	DSKP-300-14	300	M14	32	24.5	119	15	48	41	19	2,550	26.00	10
ONKA-6099	DSKP-300-16	300	M16	32	24.5	119	17	48	41	19	2,550	26.00	10
ONKA-6100	DSKP-300-20	300	M20	32	24.5	119	21	48	41	19	2,550	26.00	10
ONKA-6101	DSKP-400-14	400	M14	38.5	27.5	140	15	55	41	19	2,500	71.25	10
ONKA-6102	DSKP-400-16	400	M16	38.5	27.5	140	17	55	41	19	2,500	71.25	10
ONKA-6103	DSKP-400-20	400	M20	38.5	27.5	140	21	55	41	19	2,500	71.25	10
ONKA-6104	DSKP-500-20	500	M20									☎	10
ONKA-6105	DSKP-625-20	625	M20									☎	10

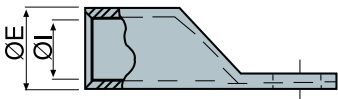
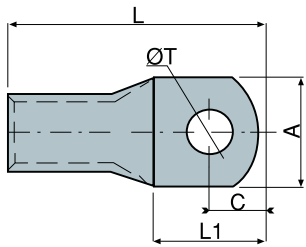



### 90° SKP (BAKIR)

6 mm<sup>2</sup>'den 400 mm<sup>2</sup>'ye kadar



### 45° SKP (BAKIR)

6 mm<sup>2</sup>'den 400 mm<sup>2</sup>'ye kadar



### VİDALI SKP (ALÜMİNYUM)

16 mm<sup>2</sup>'den 300 mm<sup>2</sup>'ye kadar

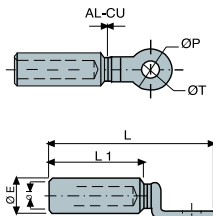
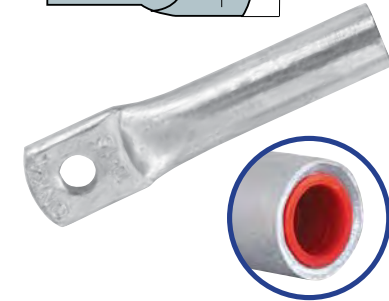
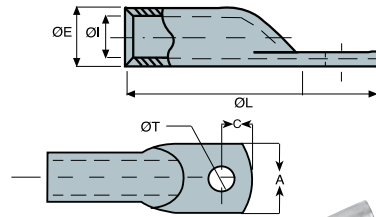
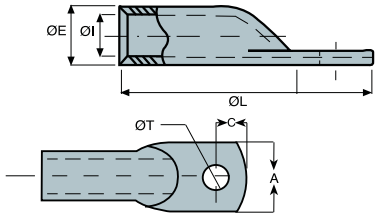

### ALÜMİNYUM DIN NORMU SKP SIKMALI KABLO PAPUÇLARI

KOD	REF. NO	K. KESİTİ mm <sup>2</sup>	ÇİVATA	ØE	ØI	ØL	ØT	A	L1	C	AĞIRLIK	AD. / ʘ	K. AD.
ONKA-6122	DSKP-10	10	M6	8	5	50	6.4	9	14	7	0,88	0.60	300
ONKA-6123	DSKP-16	16	M6	10	6	56	6.4	13	15	7.5	1,3	0.72	200
ONKA-6124	DSKP-25	25	M8	12	7	62	8.4	16	18	9	1,7	0.96	100
ONKA-6125	DSKP-35	35	M10	14	8.2	73	10.5	19	20	10	2,5	1.36	75
ONKA-6126	DSKP-50	50	M10	16	10	80	10.5	22	23	11.5	3,4	1.90	70
ONKA-6127	DSKP-70	70	M10	18	12	94	10.5	24	25	12.5	5,4	2.41	40
ONKA-6128	DSKP-95	95	M12	22	13.4	102	13	28	27	13.5	8,66	3.97	25
ONKA-6129	DSKP-120	120	M12	23	16	112	13	32	32	16	11	4.10	25
ONKA-6130	DSKP-150	150	M14	26	17	114	15	34	35	17.5	16,4	5.60	15
ONKA-6131	DSKP-185	185	M14	28	18.5	125	15	37	38	19	18	6.99	10
ONKA-6132	DSKP-240	240	M14	32	22	141.5	17	42	40	20		9.53	8

### ALÜMİNYUM DIN NORMU SKP SIKMALI KABLO PAPUÇLARI (KALAY KAPLI, TAPALI, YAĞLI)

KOD	REF. NO	K. KESİTİ mm <sup>2</sup>	ÇİVATA	ØE	ØI	ØL	ØT	A	L1	C	AĞIRLIK	AD. / ʘ	K. AD.
ONKA-6237	DSKP-10	10	M6	8	5	50	6.4	9	14	7	0,88	0.67	300
ONKA-6238	DSKP-16	16	M6	10	6	56	6.4	13	15	7.5	1,3	1.08	200
ONKA-6239	DSKP-25	25	M8	12	7	62	8.4	16	18	9	1,7	1.50	100
ONKA-6240	DSKP-35	35	M10	14	8.2	73	10.5	19	20	10	2,5	2.07	75
ONKA-6241	DSKP-50	50	M10	16	10	80	10.5	22	23	11.5	3,4	2.90	70
ONKA-6242	DSKP-70	70	M10	18	12	94	10.5	24	25	12.5	5,4	3.75	40
ONKA-6243	DSKP-95	95	M12	22	13.4	102	13	28	27	13.5	8,66	7.58	25
ONKA-6244	DSKP-120	120	M12	23	16	112	13	32	32	16	11	8.50	25
ONKA-6245	DSKP-150	150	M14	26	17	114	15	34	35	17.5	16,4	9.75	15
ONKA-6246	DSKP-185	185	M14	28	18.5	125	15	37	38	19	18	10.85	10
ONKA-6247	DSKP-240	240	M14	32	22	141.5	17	42	40	20		16.20	8

### BAKIR ALÜMİNYUMLU SKP (Bimetalik)

KOD	REF. NO	K. KESİTİ mm <sup>2</sup>	ØE	ØI	L	ØT	L1	AĞIRLIK	AD. / ʘ	K. AD.
ONKA - 6108	TBF-16	16	20	6,5	84	12,8	46	7,2	8.00	30
ONKA - 6109	TBF-25	25	20	6,5	84	12,8	46	7,2	8.50	30
ONKA - 6110	TBF-35	35	20	8	84	12,8	46	7,2	8.50	30
ONKA - 6111	TBF-50	50	20	9	84	12,8	46	7	13.00	30
ONKA - 6112	TBF-70	70	20	11	84	12,8	46	7	13.50	30
ONKA - 6113	TBF-95	95	20	12,5	84	12,8	46	6,3	14.00	30
ONKA - 6114	TBF-120	120	25	13,7	107	12,8	62,5	13,5	21.50	30
ONKA - 6115	TBF-150	150	25	15,5	107	12,8	62,5	12,2	22.00	30
ONKA - 6116	TBF-185	185	32	17	117	14,5	64	20,1	36.00	30
ONKA - 6117	TBF-240	240	32	19,5	117	14,5	64	22,6	37.00	15
ONKA - 6118	TBF-300	300	36	23,3	157	16,3	90	33,4	49.00	15
ONKA - 6119	TBF-400	400	36	26	157	16,3	90	30,2	59.00	10

KAYNAKLI TİP SKP

DIN 46234 Standartı, Bakır Malzemeden Kalay Kaplı



KOD	KABLO KESİTİ	METRİK ÖLÇÜSÜ (d2)	d <sub>1</sub>	l <sub>1</sub>	b	l <sub>2</sub>	d <sub>2</sub>	AD. / ̸	K. AD.
ONKA-102000	0.5 - 1	M2.5	1.6	10.8	6.0	4.8	2,2	0.117	1000
ONKA-102002	0.5 - 1	M3	1.6	10.8	6.0	4.8	3,2	0.119	1000
ONKA-102004	0.5 - 1	M3.5	1.6	10.8	6.0	4.8	3,7	0.123	1000
ONKA-102006	0.5 - 1	M4	1.6	11.8	8.0	4.8	4,3	0.136	1000
ONKA-102008	0.5 - 1	M5	1.6	12.8	10.0	4.8	5,3	0.169	1000
ONKA-102010	0.5 - 1	M6	1.6	14.8	11.0	4.8	6,5	0.175	1000
ONKA-102011	0.5 - 1	M8	1.6	17.0	14.0	4.8	8,4	0.208	1000
ONKA-102012	1.5 - 2.5	M3	2.3	10.8	6.0	4.8	3,2	0.119	1000
ONKA-102014	1.5 - 2.5	M3.5	2.3	10.8	6.0	4.8	3,7	0.119	1000
ONKA-102016	1.5 - 2.5	M4	2.3	11.8	8.0	4.8	4,3	0.131	1000
ONKA-102018	1.5 - 2.5	M5	2.3	13.8	10.0	4.8	5,3	0.143	1000
ONKA-102020	1.5 - 2.5	M6	2.3	15.8	11.0	4.8	6,5	0.179	1000
ONKA-102022	1.5 - 2.5	M8	2.3	16.8	14.0	4.8	8,4	0.239	1000
ONKA-102023	1.5 - 2.5	M10	2.3	17.0	15.0	4.8	10,5	0.262	1000
ONKA-102024	4 - 6	M4	3.6	14.0	8.0	6.0	4,3	0.266	100
ONKA-102026	4 - 6	M5	3.6	15.0	10.0	6.0	5,3	0.266	100
ONKA-102028	4 - 6	M6	3.6	16.0	11.0	6.0	6,5	0.266	100
ONKA-102030	4 - 6	M8	3.6	19.0	14.0	6.0	8,4	0.358	100
ONKA-102032	4 - 6	M10	3.6	21.0	18.0	6.0	10,5	0.418	100
ONKA-102033	4 - 6	M12	3.6	21.0	18.0	6.0	13,0	0.478	100
ONKA-102034	10	M4	4.5	16.0	10.0	8.0	4,3	0.418	100
ONKA-102036	10	M5	4.5	16.0	10.0	8.0	5,3	0.429	100
ONKA-102038	10	M6	4.5	17.0	11.0	8.0	6,5	0.442	100
ONKA-102040	10	M8	4.5	20.0	14.0	8.0	8,4	0.514	100
ONKA-102042	10	M10	4.5	21.0	18.0	8.0	10,5	0.598	100
ONKA-102044	10	M12	4.5	23.0	22.0	8.0	13,0	0.741	100
ONKA-102046	16	M5	5.8	20.0	11.0	10.0	5,3	0.682	100
ONKA-102048	16	M6	5.8	20.0	11.0	10.0	6,5	0.694	100
ONKA-102050	16	M8	5.8	22.0	14.0	10.0	8,4	0.741	100
ONKA-102052	16	M10	5.8	24.0	18.0	10.0	10,5	0.860	100
ONKA-102054	16	M12	5.8	26.0	22.0	10.0	13,0	1.005	100
ONKA-102056	25	M5	7.5	25.0	12.0	11.0	5,3	1.124	100
ONKA-102058	25	M6	7.5	25.0	12.0	11.0	6,5	1.124	100
ONKA-102060	25	M8	7.5	25.0	16.0	11.0	8,4	1.124	100
ONKA-102062	25	M10	7.5	26.0	18.0	11.0	10,5	1.196	100
ONKA-102064	25	M12	7.5	31.0	22.0	11.0	13,0	1.820	100
ONKA-102066	25	M14	7.5	31.0	22.0	11.0	15,0	1.885	100
ONKA-102068	25	M16	7.5	35.0	28.0	11.0	17,0	1.913	100
ONKA-102070	35	M6	9.0	26.0	15.0	12.0	6,5	1.521	100
ONKA-102072	35	M8	9.0	26.0	16.0	12.0	8,4	1.547	100
ONKA-102074	35	M10	9.0	27.0	18.0	12.0	10,5	1.674	100
ONKA-102076	35	M12	9.0	31.0	22.0	12.0	13,0	2.033	100
ONKA-102078	35	M14	9.0	31.0	22.0	12.0	15,0	2.405	100
ONKA-102080	35	M16	9.0	35.0	28.0	12.0	17,0	2.631	100
ONKA-102082	50	M6	11.0	34.0	18.0	16.0	6,5	2.631	100
ONKA-102084	50	M8	11.0	34.0	18.0	16.0	8,4	2.631	100
ONKA-102086	50	M10	11.0	34.0	18.0	16.0	10,5	2.750	100
ONKA-102088	50	M12	11.0	36.0	22.0	16.0	13,0	2.893	100
ONKA-102090	50	M14	11.0	36.0	22.0	16.0	15,0	3.827	100
ONKA-102092	50	M16	11.0	40.0	22.0	16.0	17,0	4.066	100
ONKA-102093	70	M6	15.0	38.0	22.0	18.0	6,5	3.946	100
ONKA-102094	70	M8	15.0	38.0	22.0	18.0	8,4	3.946	100
ONKA-102096	70	M10	15.0	38.0	22.0	18.0	10,5	3.946	100
ONKA-102098	70	M12	15.0	38.0	22.0	18.0	13,0	3.946	100
ONKA-102100	70	M14	15.0	38.0	22.0	18.0	15,0	4.066	100
ONKA-102102	70	M16	15.0	42.0	28.0	18.0	17,0	4.186	100
ONKA-102103	95	M8	15.0	42.0	24.0	20.0	8,4	5.740	100
ONKA-102104	95	M10	15.0	42.0	24.0	20.0	10,5	5.740	100
ONKA-102106	95	M12	15.0	42.0	24.0	20.0	13,0	5.740	100
ONKA-102108	95	M14	15.0	42.0	24.0	20.0	15,0	5.860	100
ONKA-102110	95	M16	15.0	44.0	28.0	20.0	17,0	5.980	100
ONKA-102111	120	M8	16.5	44.0	24.0	22.0	8,4	7.893	50
ONKA-102112	120	M10	16.5	44.0	24.0	22.0	10,5	7.893	50
ONKA-102114	120	M12	16.5	44.0	24.0	22.0	13,0	7.893	50
ONKA-102116	120	M14	16.5	44.0	24.0	22.0	15,0	9.568	50
ONKA-102118	120	M16	16.5	48.0	28.0	22.0	17,0	10.524	50
ONKA-102120	150	M10	19.0	50.0	30.0	24.0	10,5	13.754	50
ONKA-102123	150	M12	19.0	50.0	30.0	24.0	13,0	13.754	50
ONKA-102124	150	M14	19.0	50.0	30.0	24.0	15,0	14.300	50
ONKA-102126	150	M16	19.0	50.0	30.0	24.0	17,0	14.350	50
ONKA-102127	185	M10	21.0	50.0	36.0	28.0	10,5	19.136	50
ONKA-102128	185	M12	21.0	50.0	36.0	28.0	13,0	19.032	50
ONKA-102130	185	M14	21.0	50.0	36.0	28.0	15,0	20.098	50
ONKA-102132	185	M16	21.0	50.0	36.0	28.0	17,0	20.098	50
ONKA-102133	240	M10	23.5	56.0	38.0	32.0	10,5	26.312	50
ONKA-102134	240	M12	23.5	56.0	38.0	32.0	13,0	27.508	50
ONKA-102136	240	M14	23.5	56.0	38.0	32.0	15,0	27.508	50
ONKA-102138	240	M16	23.5	56.0	38.0	32.0	17,0	27.508	50

## SKP İZOLASYON KILIFI



KOD	KESİT (mm <sup>2</sup> )	RENK	CİVATA	AD./ ʘ	K. AD.
SKP-PK10	10	■ ■ ■ ■ ■ ■	10'luk SKP İzolasyon Kılıfı	0.03	600
SKP-PK16	16	■ ■ ■ ■ ■ ■	16'lık SKP İzolasyon Kılıfı	0.05	300
SKP-PK25	25	■ ■ ■ ■ ■ ■	25'lik SKP İzolasyon Kılıfı	0.09	200
SKP-PK35	35	■ ■ ■ ■ ■ ■	35'lik SKP İzolasyon Kılıfı	0.12	150
SKP-PK50	50	■ ■ ■ ■ ■ ■	50'lik SKP İzolasyon Kılıfı	0.16	125
SKP-PK70	70	■ ■ ■ ■ ■ ■	70'lik SKP İzolasyon Kılıfı	0.25	80
SKP-PK95	95	■ ■ ■ ■ ■ ■	95'lik SKP İzolasyon Kılıfı	0.37	60
SKP-PK120	120	■ ■ ■ ■ ■ ■	120'lik SKP İzolasyon Kılıfı	0.40	40
SKP-PK150	150	■ ■ ■ ■ ■ ■	150'lik SKP İzolasyon Kılıfı	0.53	30
SKP-PK185	185	■ ■ ■ ■ ■ ■	185'lik SKP İzolasyon Kılıfı	0.76	20
SKP-PK240	240	■ ■ ■ ■ ■ ■	240'lik SKP İzolasyon Kılıfı	0.96	15

ALÜMİNYUM-BAKIR  
EK MUFU (PİNLİ)25-16 mm<sup>2</sup>'den 300-240 mm<sup>2</sup>'ye kadarALÜMİNYUM-BAKIR  
EK MUFU25-16 mm<sup>2</sup>'den 300-240 mm<sup>2</sup>'ye kadarALÜMİNYUM VİDALI  
EK MUFU16-35 mm<sup>2</sup>'den 120-240 mm<sup>2</sup>'ye kadar

## BAKIR STANDART SIKMALI EK MUFLAR



KOD	CİNSİ	K. KESİTİ	ØE	Øİ	L	AD. / ʘ	K. AD.
ONKA - 6140	SEM-6	6 mm <sup>2</sup>	5.5	4	26	0.42	1000
ONKA - 6141	SEM-10	10 mm <sup>2</sup>	6.5	5	28.5	0.46	750
ONKA - 6142	SEM-16	16 mm <sup>2</sup>	7.5	6	31.25	0.58	500
ONKA - 6143	SEM-25	25 mm <sup>2</sup>	9	7.5	40	0.82	300
ONKA - 6144	SEM-35	35 mm <sup>2</sup>	10.5	8.5	43	1.37	300
ONKA - 6145	SEM-50	50 mm <sup>2</sup>	12.5	10	53	2.41	150
ONKA - 6146	SEM-70	70 mm <sup>2</sup>	14.5	12	54	2.66	100
ONKA - 6147	SEM-95	95 mm <sup>2</sup>	17	14	58	4.20	75

## EKSTRA STANDART UZUN ve KALIN TİP SIKMALI EK MUFLAR (BAKIR)



KOD	REF. NO	KABLO KESİTİ (mm <sup>2</sup> )	ØE	Øİ	L	AĞIRLIK	AD. / ʘ	K. AD.
ONKA - 6160	SEM-6	6	5.5	4	31.5	0.322	0.42	1000
ONKA - 6161	SEM-10	10	6.5	5	31.5	0.440	0.55	750
ONKA - 6162	SEM-16	16	8	6	34	0.640	0.87	500
ONKA - 6163	SEM-25	25	9	7	42	1.13	1.10	400
ONKA - 6164	SEM-35	35	11	8.5	48	1.57	1.83	250
ONKA - 6165	SEM-50	50	13	10	56	2.51	3.00	150
ONKA - 6166	SEM-70	70	15	12	59	3.24	3.55	100
ONKA - 6167	SEM-95	95	17	14	65	4.07	5.45	75
ONKA - 6168	SEM-120	120	19	15	76	5.80	7.55	50
ONKA - 6169	SEM-150	150	21	17	82	9.32	10.00	35
ONKA - 6170	SEM-185	185	23	19	93.5	11.32	14.30	25
ONKA - 6171	SEM-240	240	25	21	103	15.80	14.95	20
ONKA - 6172	SEM-300	300	29	24	112	18.62	21.60	15
ONKA - 6173	SEM-400	400	32	27	129	27.12	27.25	10
ONKA - 6174	SEM-500	500					ʘ	10
ONKA - 6175	SEM-600	600					ʘ	10

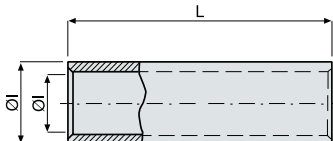



## DIN NORMU 46235 TİP SIKMALI EK MUFLAR (BAKIR)

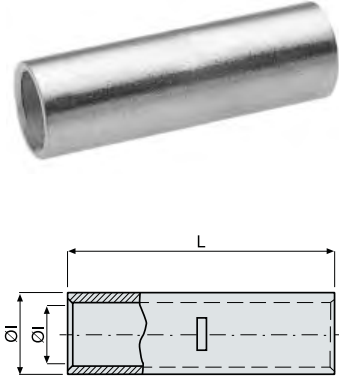

KOD	REF. NO	KABLO KESİTİ (mm <sup>2</sup> )	ØE	Øİ	L	AĞIRLIK	AD. / ʘ	K. AD.
ONKA - 6180	SEM-6	6	6	4	36	0.290	0.47	500
ONKA - 6181	SEM-10	10	6	5	39	0.410	0.57	400
ONKA - 6182	SEM-16	16	6.5	5	53	1.450	1.27	250
ONKA - 6183	SEM-25	25	10	7.5	54	1.830	1.73	250
ONKA - 6184	SEM-35	35	12.5	8.5	60	3.550	3.40	100
ONKA - 6185	SEM-50	50	14.5	10	70	5.300	4.85	100
ONKA - 6186	SEM-70	70	16.5	12	74	7.020	6.25	50
ONKA - 6187	SEM-95	95	19	13.5	84	10.300	10.35	50
ONKA - 6188	SEM-120	120	21	15.5	91	12.900	12.85	50
ONKA - 6189	SEM-150	150	23	17	100	18.400	18.70	20
ONKA - 6190	SEM-185	185	25.5	18	103	21.000	21.75	20
ONKA - 6191	SEM-240	240	28	22	113	36.500	24.90	10
ONKA - 6192	SEM-300	300	32	24.5	122	36.500	34.50	10
ONKA - 6193	SEM-400	400	38.5	27.5	145	36.500	76.50	10
ONKA - 6194	SEM-500	500					ʘ	10
ONKA - 6195	SEM-600	600					ʘ	10

## ALÜMİNYUM DIN NORMU SIKMALI EK MUFLAR



KOD	K. KESİTİ	ØE	Øİ	L	AD. / ʘ	K. AD.
ONKA - 6270	10 mm <sup>2</sup>	8	5	52	0.60	300
ONKA - 6271	16 mm <sup>2</sup>	10	6	58	0.73	250
ONKA - 6272	25 mm <sup>2</sup>	12	7	64	1.00	150
ONKA - 6273	35 mm <sup>2</sup>	14	8.2	75	1.41	100
ONKA - 6274	50 mm <sup>2</sup>	16	10	82	1.94	75
ONKA - 6275	70 mm <sup>2</sup>	18	12	96	2.47	40
ONKA - 6276	95 mm <sup>2</sup>	22	13.4	104	4.00	20
ONKA - 6277	120 mm <sup>2</sup>	22	16	114	4.30	15
ONKA - 6278	150 mm <sup>2</sup>	26	17	116	5.65	8
ONKA - 6279	185 mm <sup>2</sup>	28	18.5	127	7.05	7
ONKA - 6280	240 mm <sup>2</sup>	32	22	143.5	9.65	5

## VİDALI EK MUFLAR (MS 58) PRİNÇ



KOD	CİNSİ	AD. / ʘ	K. AD.
ONKA - 6200	6'lık Vidalı Ek Muf	0.50	400
ONKA - 6201	10'luk Vidalı Ek Muf	0.55	300
ONKA - 6202	16'lık Vidalı Ek Muf	0.97	250
ONKA - 6203	25'lik Vidalı Ek Muf	1.50	200
ONKA - 6204	35'lik Vidalı Ek Muf	1.70	200
ONKA - 6205	50'lik Vidalı Ek Muf	1.90	150
ONKA - 6206	70'lik Vidalı Ek Muf	3.55	100
ONKA - 6207	95'lik Vidalı Ek Muf	6.65	50
ONKA - 6208	120'lik Vidalı Ek Muf	7.50	30

## VİDALI KLEMENS İÇİLERİ (MS 58) PRİNÇ



KOD	CİNSİ	AD. / ʘ	K. AD.
ONKA - 6220	1'lik Klemens İçi - 2,5 - 4 mm <sup>2</sup>	0.19	1000
ONKA - 6221	2'lik Klemens İçi - 4 - 6 mm <sup>2</sup>	0.26	1000
ONKA - 6222	3'lik Klemens İçi - 6 - 10 mm <sup>2</sup>	0.34	1000
ONKA - 6223	4'lik Klemens İçi - 10 - 16 mm <sup>2</sup>	0.61	1000
ONKA - 6224	5'lik Klemens İçi - 16 - 25 mm <sup>2</sup>	0.76	1000

## U KLEMENSLER

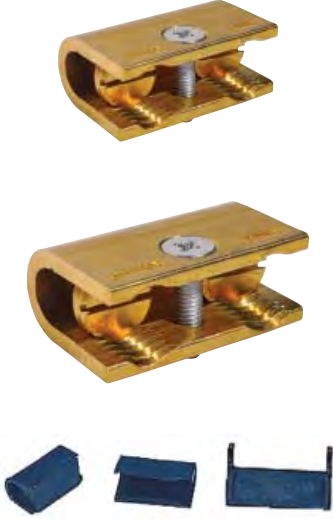

KOD	CİNSİ	AD. / ʘ	K. AD.
ONKA - 7050	6'lık U Klemens	1.46	300
ONKA - 7051	10'luk U Klemens	1.83	300
ONKA - 7052	16'lık U Klemens	2.50	200
ONKA - 7053	25'lik U Klemens	3.58	100
ONKA - 7054	35'lik U Klemens	4.23	75
ONKA - 7055	50'lik U Klemens	7.50	50
ONKA - 7056	70'lik U Klemens	9.00	40
ONKA - 7057	95'lik U Klemens	10.50	30
ONKA - 7058	120'lik U Klemens	12.00	20
ONKA - 7059	150'lik U Klemens	17.10	10
ONKA - 7060	U Klemens Kayığı	1.70	100

## TIRNAKLI KLEMENSLER



KOD	CİNSİ	AD. / ʘ	K. AD.
ONKA - 7070	No. 1 16 mm <sup>2</sup>	1.40	500
ONKA - 7071	No. 2 25 mm <sup>2</sup>	1.90	250
ONKA - 7072	No. 3 35 mm <sup>2</sup>	2.85	100
ONKA - 7073	No. 4 50 mm <sup>2</sup>	4.25	100
ONKA - 7074	No. 5 70 mm <sup>2</sup>	6.65	100
ONKA - 7075	No. 6-7 120 mm <sup>2</sup>	11.20	50

## KONDANSATÖR KLEMENSLERİ



KOD	CİNSİ	AD. / ʘ	K. AD.
ONKA - 7094	Kondansatör Klemensi M12	Ⓛ	100
ONKA - 7095	Kondansatör Klemensi M14	Ⓛ	100
ONKA - 7096	Kondansatör Klemensi M16	Ⓛ	100

## H KLEMENSLER

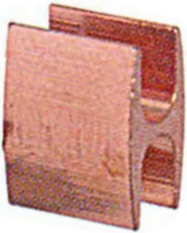

KOD	CİNSİ	SIKMA SAHASI (mm <sup>2</sup> )	KULLANILACAĞI İLETKENLER	AD. / ʘ	K. AD.
ONKA - 7068	H16-25-35-50-70-95-120	30	22	Ⓛ	50

## C KLEMENSLER



KOD	CİNSİ	SIKMA SAHASI (mm <sup>2</sup> )	KULLANILACAĞI İLETKENLER	AD. / ʘ	K. AD.
ONKA - 7061	CK01 16 - 25	18	16	4.95	50
ONKA - 7062	CK02 25 - 35	27	20	6.80	50
ONKA - 7063	CK03 35 - 50	32	25	8.80	50
ONKA - 7064	CK04 50 - 70	41	30	10.90	50
ONKA - 7065	CK05 70 - 95	45	35	17.50	50
ONKA - 7066	CK06 95 - 120	60	40	21.50	50
ONKA - 7067	CK07 120 - 150	65	45	35.50	50

## AL - CU KLEMENSLER



KOD	CİNSİ	SIKMA SAHASI (mm <sup>2</sup> )	KULLANILACAĞI İLETKENLER	AD. / ʘ	K. AD.
ONKA - 7001	A 25 - B 16 AL-CU Kl.m.	6 - 25 Al / 25 - 16 Cu	Rose	2.76	100
ONKA - 7002	A 40 - B 25 AL-CU Kl.m.	16 - 40 Al / 10 - 25 Cu	Rose, Lily, Swallow, Sparrov	3.17	100
ONKA - 7003	A 70 - B 50 AL-CU Kl.m.	16 - 70 Al / 10 - 50 Cu	Rose, Lily, Swallow, Sparrov	5.60	50
ONKA - 7004	A 120 - B 50 AL-CU Kl.m.	70 - 120 Al / 10 - 50 Cu	Pannsey, Aster, Pholx, Oxlip Raven, Pigeon	9.20	50
ONKA - 7005	A 120 - B 70 AL-CU Kl.m.	70 - 120 Al / 10 - 70 Cu	Pannsey, Aster, Pholx, Oxlip Raven, Pigeon	9.55	50
ONKA - 7006	A 240 - B 120 AL-CU Kl.m.	70 - 240 Al / 50 - 120 Cu	Daisy, Peony, Tulip, Canna Patridge, Ostrich, Hawk	27.55	25
ONKA - 7007	A 240 - B 240 AL-CU Kl.m.	240 Al / 240 Cu	Daisy, Peony, Tulip, Canna Patridge, Ostrich, Hawk	31.00	25

## BRANŞMAN KLEMENSLER



KOD	CİNSİ	SIKMA SAHASI (mm <sup>2</sup> )	KULLANILACAĞI İLETKENLER	AD. / ʘ	K. AD.
ONKA - 7020	A16-16 Braşman Kl.m.	6 - 16 Al	Rose	1.40	100
ONKA - 7021	A25-25 Braşman Kl.m.	6 - 25 Al	Rose	1.60	100
ONKA - 7022	A40-40 Braşman Kl.m.	16 - 40 Al	Rose, Lily, Swallow, Sparrov	2.20	100
ONKA - 7023	A70-70 Braşman Kl.m.	16 - 70 Al	Rose, Lily, Pansy, Swallow, Sparrov	3.85	50
ONKA - 7024	A95-95 Braşman Kl.m.	25 - 95 Al	Lily, Pansy, Swallow, Aster, Rawen	6.00	50
ONKA - 7025	A120-120 Braşman Kl.m.	40 - 120 Al	Pannsey, Aster, Pholx, Oxlip Swallow, robinone, Rawen	6.20	50
ONKA - 7026	A150-150 Braşman Kl.m.	40 - 150 Al	Pannsey, Aster, Pholx, Oxlip Swallow, robinone, Rawen	13.15	25
ONKA - 7027	A240-240 Braşman Kl.m.	40 - 240 Al	Daisy, Peony, Tulip, Canna Patridge, Ostrich, Hawk	22.00	25
ONKA - 7028	Klemens Kapağı		A70-A70/A70-B50	2.40	100

## DURDURUCU KLEMENSLER



KOD	CİNSİ	SIKMA SAHASI (mm <sup>2</sup> )	KULLANILACAĞI İLETKENLER	AD. / ʘ	K. AD.
ONKA - 7040	A16-A50 Durdurucu Kl.m.	16 - 50 Al	Rose, Lily, Swallow, Sparrov, Swallow	4.60	50
ONKA - 7041	A50-A95 Durdurucu Kl.m.	50 - 95 Al	Popy, Aster, Pholx, Raven, Rabinone	6.10	50
ONKA - 7042	A95-A120 Durdurucu Kl.m.	95 - 120 Al	Popy, Aster, Pholx, Raven, Rabinone	11.50	50

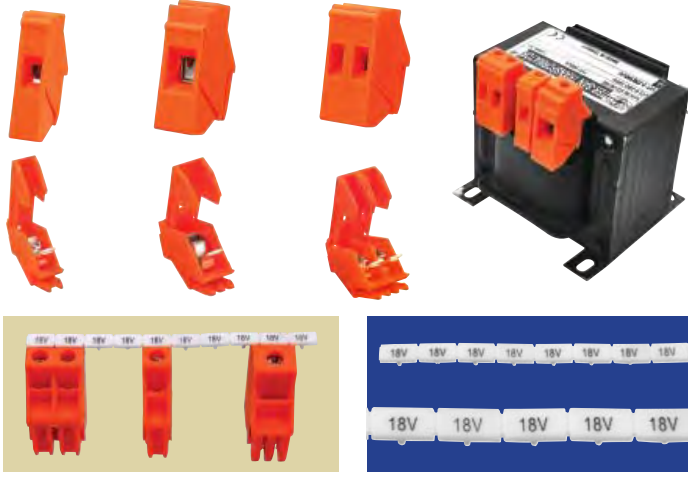

### TRAFO KLEMENSLERİ ve ETİKETLERİ

KOD	CİNSİ	AD. / ʘ	K. AD.
ONKA - 5135	1 x 4 mm <sup>2</sup> Yüksek Tip	0.76	200
ONKA - 5136	2x 4 mm <sup>2</sup> Yüksek Tip	1.28	100
ONKA - 5137	1 x 6 mm <sup>2</sup> Yüksek Tip	1.10	100
ONKA - 5139	Trafo Klemens Etik. Yazısız	0.05	500
ONKA - 5140	Trafo Klemens Etik. Yazılı	0.08	500

### MODÜL CİHAZ KLEMENSLERİ (PALETLİ KALAY KAPLAMALI DEKAFİX'Lİ ÇİFT RENKLİ)



KOD	CİNSİ	AD. / ʘ	K. AD.
ONKA - 5100	No 1	1.00	250
ONKA - 5101	No 2	1.38	144
ONKA - 5102	No 3	2.22	75
ONKA - 5103	No 1-3'lü	1.40	200

### MİNİ KLEMENS (Aspratör Klemens)

KOD	CİNSİ	AD. / ʘ	K. AD.
ONKA - 5130	Miniklemens (Aspratör) 2.5 - 4 mm <sup>2</sup> 400 V - 32 A	0.45	250

### PORSELEN KLEMENSLER KALAY KAPLAMALI



KOD	CİNSİ	AD. / ʘ	K. AD.
ONKA - 5081	No. 0 2'li Lüster	1.31	150
ONKA - 5082	No. 1 2'li Lüster	1.31	150
ONKA - 5083	No. 1 3'lü Lüster	1.53	100
ONKA - 5084	No. 2 2'li Lüster	1.61	100
ONKA - 5085	No. 2 3'lü Lüster	2.10	50
ONKA - 5086	No. 3 2'li Lüster	2.18	50
ONKA - 5087	No. 3 3'lü Lüster	2.87	35
ONKA - 5088	No. 0 1'li Lüster	0.80	400
ONKA - 5089	No. 1 1'li Lüster	0.83	350
ONKA - 5090	No. 2 1'li Lüster	1.09	200
ONKA - 5091	No. 3 1'li Lüster	1.24	100
ONKA - 5096	Porselen Kl. Kapağı	0.12	100
ONKA - 5093	No. 4 3'lü Lüster (Kondansatör için)	3.74	20
ONKA - 5095	No. 5 2'li Lüster	2.76	20
ONKA - 5094	No. 5 3'lü Lüster (Kondansatör için)	4.28	20

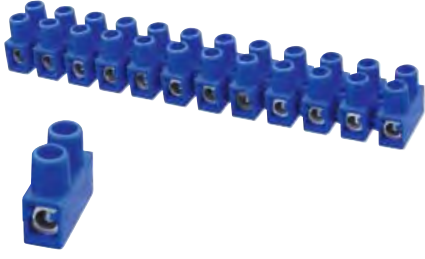

## PLASTİK SIRA KLEMENSLER KALAY KAPLAMALI, VİDA BLOKAJLI - (MAVİ)

KOD	CİNSİ	VOLT	AMPER	AD. / ʘ	K. AD.
ONKA - 5000	No. 0 0.75 - 1.5 mm <sup>2</sup> 'lik 12 Sıra	400	17.5	1.60	100
ONKA - 5001	No. 1 2.5 - 4 mm <sup>2</sup> 'lik 12 Sıra	400	32	2.00	50
ONKA - 5002	No. 2 4 - 6 mm <sup>2</sup> 'lik 12 Sıra	400	41	2.95	50
ONKA - 5003	No. 3 6 - 10 mm <sup>2</sup> 'lik 10 Sıra	400	57	3.42	50
ONKA - 5004	No. 4 10 - 16 mm <sup>2</sup> 'lik 6 Sıra	500	76	3.91	50
ONKA - 5005	No. 5 16 - 25 mm <sup>2</sup> 'lik 6 Sıra	500	101	4.90	50

## ISIYA DAYANIKLI PLASTİK, KALAY KAP., VİDA BLOKAJLI - (BEYAZ - KIRMIZI) 140 °C V2



KOD	CİNSİ	VOLT	AMPER	AD. / ʘ	K. AD.
ONKA - 5010	No. 0 0.75 - 1.5 mm <sup>2</sup> 'lik 12 Sıra	400	17.5	1.89	100
ONKA - 5011	No. 1 2.5 - 4 mm <sup>2</sup> 'lik 12 Sıra	400	32	2.24	50
ONKA - 5012	No. 2 4 - 6 mm <sup>2</sup> 'lik 12 Sıra	400	41	3.34	50
ONKA - 5013	No. 3 6 - 10 mm <sup>2</sup> 'lik 10 Sıra	400	57	3.88	50
ONKA - 5014	No. 4 10 - 16 mm <sup>2</sup> 'lik 6 Sıra	500	76	4.45	50
ONKA - 5015	No. 5 16 - 25 mm <sup>2</sup> 'lik 6 Sıra	500	101	5.49	50
ONKA - 5016	No. 3 3'lü 6 - 10 mm <sup>2</sup> 'lik	400	57	1.20	50

## ISIYA DAYANIKLI PLASTİK, KALAY KAP., VİDA BLOKAJLI - (ŞEFFAF - POLİKARBON)



KOD	CİNSİ	VOLT	AMPER	AD. / ʘ	K. AD.
ONKA - 5020	No. 0 0.75 - 1.5 mm <sup>2</sup> 'lik 12 Sıra	400	17.5	2.25	100
ONKA - 5021	No. 1 2.5 - 4 mm <sup>2</sup> 'lik 12 Sıra	400	32	2.66	50
ONKA - 5022	No. 2 4 - 6 mm <sup>2</sup> 'lik 12 Sıra	400	41	4.00	50
ONKA - 5023	No. 3 6 - 10 mm <sup>2</sup> 'lik 10 Sıra	400	57	4.68	50
ONKA - 5024	No. 4 10 - 16 mm <sup>2</sup> 'lik 6 Sıra	500	76	5.43	50
ONKA - 5025	No. 5 16 - 25 mm <sup>2</sup> 'lik 6 Sıra	500	101	6.60	50
ONKA - 5026	No. 3 3'lü 6 - 10 mm <sup>2</sup> 'lik	400	57	1.68	50

## PANO İÇİ YÜKSEK ISIYA DAYANIKLI KALAY KAP., VİDA BLOKAJLI - (200° HA66-VO)



KOD	CİNSİ	VOLT	AMPER	AD. / ʘ	K. AD.
ONKA - 5029	No. 0 0.75 - 1.5 mm <sup>2</sup> 'lik 12 Sıra	400	17.5	2.40	100
ONKA - 5030	No. 1 2.5 - 4 mm <sup>2</sup> 'lik 12 Sıra	400	32	2.90	50
ONKA - 5031	No. 2 4 - 6 mm <sup>2</sup> 'lik 12 Sıra	400	41	4.40	50
ONKA - 5032	No. 3 6 - 10 mm <sup>2</sup> 'lik 10 Sıra	400	57	5.14	50
ONKA - 5033	No. 4 10 - 16 mm <sup>2</sup> 'lik 6 Sıra	500	76	5.69	50
ONKA - 5034	No. 5 16 - 25 mm <sup>2</sup> 'lik 6 Sıra	500	101	7.26	50
ONKA - 5035	No. 3 3'lü 6 - 10 mm <sup>2</sup> 'lik	400	57	1.85	50

## PALETLİ ISIYA DAYANIKLI KALAY KAP., VİDA BLOKAJLI - (BEYAZ - KIRMIZI) 140 °C V2



KOD	CİNSİ	VOLT	AMPER	AD. / ʘ	K. AD.
ONKA - 5040	No. 1 2.5 - 4 mm <sup>2</sup> 'lik 12 Sıra	400	32	3.10	50
ONKA - 5041	No. 2 4 - 6 mm <sup>2</sup> 'lik 12 Sıra	400	41	4.90	50
ONKA - 5042	No. 3 6 - 10 mm <sup>2</sup> 'lik 10 Sıra	400	57	5.00	50
ONKA - 5043	No. 3 3'lü 6 - 10 mm <sup>2</sup> 'lik	400	57	1.75	50

## PALETLİ ISIYA DAYANIKLI KALAY KAP., VİDA BLOKAJLI - (ŞEFFAF - POLİKARBON)



KOD	CİNSİ	VOLT	AMPER	AD. / ʘ	K. AD.
ONKA - 5050	No. 1 2.5 - 4 mm <sup>2</sup> 'lik 12 Sıra	400	32	3.10	50
ONKA - 5051	No. 2 4 - 6 mm <sup>2</sup> 'lik 12 Sıra	400	41	4.90	50
ONKA - 5052	No. 3 6 - 10 mm <sup>2</sup> 'lik 10 Sıra	400	57	5.48	50
ONKA - 5053	No. 3 3'lü 6 - 10 mm <sup>2</sup> 'lik	400	57	1.95	50

## PALETLİ YÜKSEK ISIYA DAYANIKLI KALAY KAP., VİDA BLOKAJLI - (200 °C - HA66-VO)



KOD	CİNSİ	VOLT	AMPER	AD. / ʘ	K. AD.
ONKA - 5056	No. 1 2.5 - 4 mm <sup>2</sup> 'lik 12 Sıra	400	32	3.40	50
ONKA - 5057	No. 2 4 - 6 mm <sup>2</sup> 'lik 12 Sıra	400	41	5.40	50
ONKA - 5058	No. 3 6 - 10 mm <sup>2</sup> 'lik 10 Sıra	400	57	6.00	50
ONKA - 5059	No. 3 3'lü 6 - 10 mm <sup>2</sup> 'lik	400	57	2.15	50

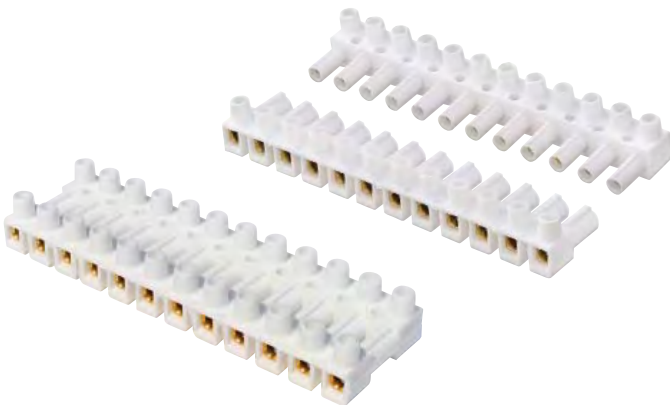
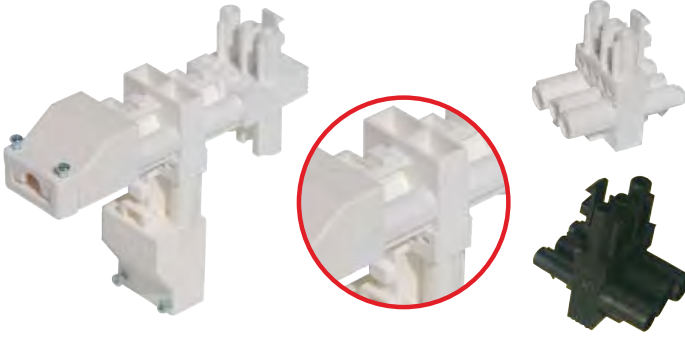

### 2'Lİ MODÜLER SİSTEM SOKET KLEMENSLER

KOD	CİNSİ	AD. / ʘ	K. AD.
ONKA - 5068	NO. 1 - 2'li Soket Klemensi + Modüler Sistem	2.22	180
ONKA - 5070	NO. 1 - 12'li Soket Klemensi + Modüler Sistem	13.35	30

### 3'LÜ SOKET KLEMENS

KOD	CİNSİ	AD. / ʘ	K. AD.
ONKA - 5065	NO. 1 3'lü Soket Klemensi	3.20	100
ONKA - 5066	Soket Klemensi Kapağı (Takım)	2.10	45
ONKA - 5067	NO. 1 3'lü Soket Klemensi + Kapak Takımı	5.50	45

### 3'LÜ SOKET KLEMENS T BAĞLANTI APARATI

KOD	CİNSİ	AD. / ʘ	K. AD.
ONKA - 5074	2.5 - 4 mm <sup>2</sup> T Bağlantı Aparatı	3.82	60

### 6'Lİ SOKET KLEMENS BAĞLANTI APARATI

KOD	CİNSİ	AD. / ʘ	K. AD.
ONKA - 5064 Beyaz	No:1, 2.5 - 4 mm <sup>2</sup> 6'lı soket kapak takım	9.50	16
ONKA - 5063 Siyah	No:1, 2.5 - 4 mm <sup>2</sup> 6'lı soket kapak takım	9.50	16

### 12'Lİ SOKET KLEMENS

KOD	CİNSİ	AD. / ʘ	K. AD.
ONKA - 5060	No. 1-12 2.5 - 4 mm <sup>2</sup> lik (Erkek Dişi Geçmeli Kilitli) (İstenilen Modül sayısında kesim yapılır.)	11.50	30



## KAPAKLI TERMİNAL KLEMENSLER 25 A

KOD	CİNSİ	AD. / ʘ	K. AD.
ONKA - 5145	25 A. 600V. Terminal-3	3.50	50
ONKA - 5146	25 A. 600V. Terminal-4	4.50	50
ONKA - 5147	25 A. 600V. Terminal-6	6.75	50
ONKA - 5148	25 A. 600V. Terminal-12	13.00	25

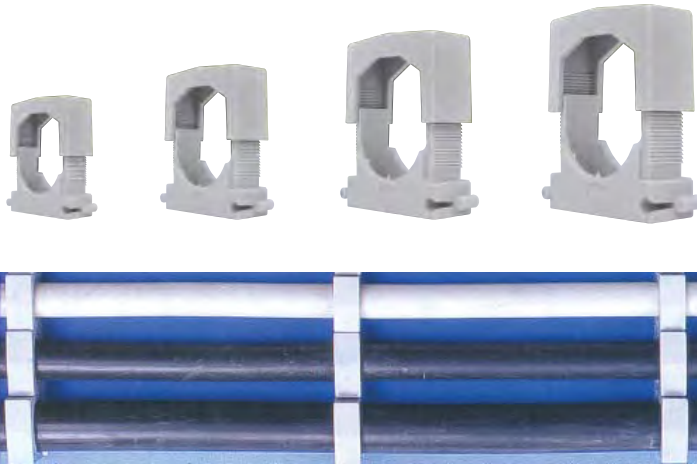

## TIRNAKLI KROŞELER (PLASTİK)

KOD	CİNSİ	AD. / ʘ	K. AD.
ONKA - 5155	No. 1 Tirnaklı Kroşe 2 x 1.5 / 2 x 2.5 / 2 x 4 / 2 x 6 3 x 1.5 / 4 x 1.5 / 3 x 2.5 / 4 x 2.5	0.18	100
ONKA - 5156	No. 2 Tirnaklı Kroşe 4 x 4 / 4 x 6	0.21	100
ONKA - 5157	No. 3 Tirnaklı Kroşe 4 x 10 NYM / 3 x 16 + 10 NYY	0.26	100
ONKA - 5158	No. 4 Tirnaklı Kroşe 3 x 25 + 16 / 3 x 35 + 16 / 3 x 50 + 25 NYY	0.37	25

## SIRA KLEMENS RAYMATİKLERİ

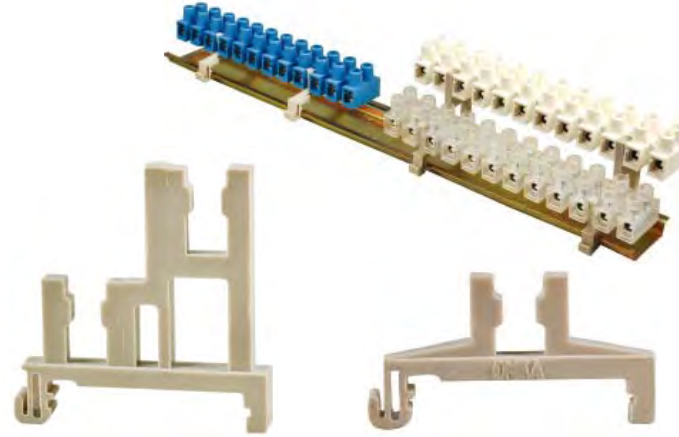

KOD	CİNSİ	AD. / ʘ	K./AD.
ONKA-5076	NO.1-2-3 Sıra Klem. Ayağı (Tek Kat)	0.36	100
ONKA-5077	NO.4-5 Sıra Klem. Ayağı (Tek Kat)	0.36	100
ONKA-5078	NO.1-2-3 Sıra Klemens Ayağı (İki Kat)	0.66	100
ONKA-5079	NO.4-5 Sıra Klemens Ayağı (İki Kat)	0.66	100

## KLEMENS TAPASI VE PLASTİK VİDA

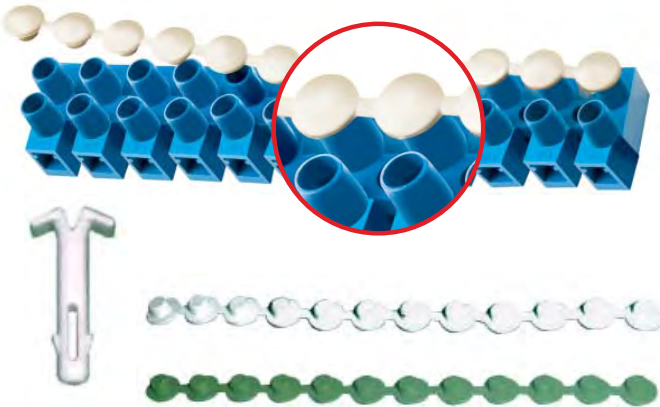

KOD	CİNSİ	AD. / ʘ	K./AD.
ONKA-5071	Klemens Tapası (12'li)	0.10	100
ONKA-5072	No: 1 - 2 Plastik Klemens Vidası	0.10	50
ONKA-5073	No: 3 Plastik Klemens Vidası	0.12	50

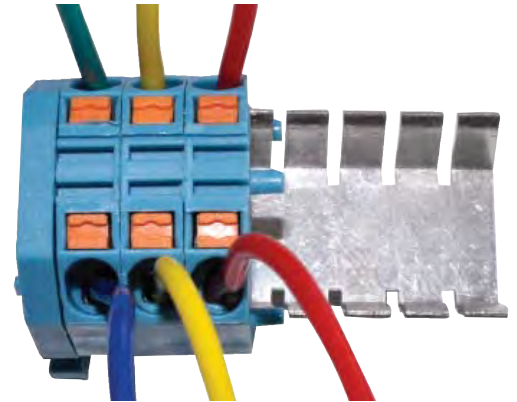
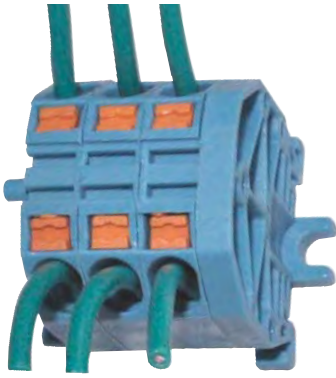
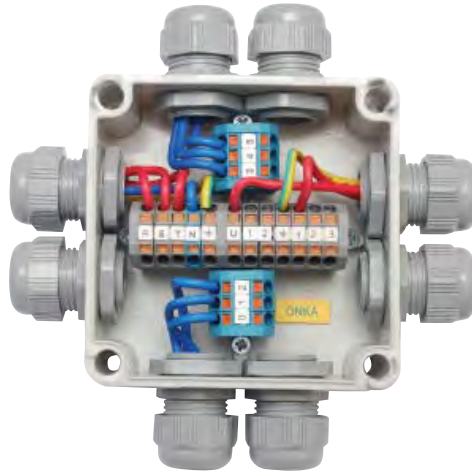

Yay Baskılı Sistem avantajı ile kablo kolayca takılabilir ve istenildiği zaman plus-in sistem sayesinde kolayca çıkarılabilir.

### BUAT İÇİ YAY BASKILI KONNEKTÖRLER



KOD	CİNSİ	AD. / ʘ	K. / AD.
ONKA - 5641	2.5 x 2 mm <sup>2</sup> 1 Giriş, 1 Çıkış	0.70	50
ONKA - 5651	2.5 x 4 mm <sup>2</sup> 1 Giriş, 3 Çıkış	1.40	50
ONKA - 5661	2.5 x 6 mm <sup>2</sup> 1 Giriş, 5 Çıkış	2.10	50
ONKA - 5671	2.5 x 8 mm <sup>2</sup> 1 Giriş, 7 Çıkış	2.80	50
ONKA - 5681	2.5 x 10 mm <sup>2</sup> 1 Giriş, 9 Çıkış	3.50	50
ONKA - 5691	15 x 5 Raya ve Zemine sabitleme aparatı	0.26	50
ONKA - 5701	Delikli zemine sabitleme aparatı	0.26	50

### BUAT İÇİ YAY BASKILI KONNEKTÖRLERİ RENK KODLARI

GRİ	KREM	SİYAH	MAVİ	KAHVERENGİ	KIRMIZI	SARI	YEŞİL
02	03	04	05	06	07	08	09



## VİDALI ŞEFFAF (RENKLİ) BUAT İÇİ KLEMENS



KOD	CİNSİ	AD. / ʘ	K. AD.
ONKA - 5504	No 1 2,5-4 mm <sup>2</sup>	0.17	600
ONKA - 5514	No 2 4-6 mm <sup>2</sup>	0.22	600
ONKA - 5524	No 3 6-10 mm <sup>2</sup>	0.32	600
ONKA - 5534	No 4 10-16 mm <sup>2</sup>	0.46	500
ONKA - 5544	No 5 16-25 mm <sup>2</sup>	0.58	500
ONKA - 5554	No 6 25-35 mm <sup>2</sup>	0.92	200

## VİDALI YAYLI BUAT KLEMENSLERİ

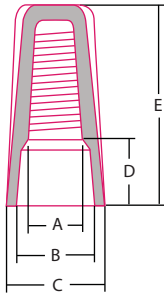

KOD	RENK	A	B	C	D	E	AD. / ʘ	K. / AD.
ONKA - 8340 / P-1	Gri	3.80	6.70	8.60	5.80	15.20	0.045	1000
ONKA - 8341 / P-2	Mavi	4.10	7.00	9.80	5.90	17.60	0.054	1000
ONKA - 8342 / P-3	Oranj	5.00	9.90	12.20	7.80	22.00	0.072	500
ONKA - 8343 / P-4	Sarı	6.00	11.20	14.00	7.90	24.00	0.090	500
ONKA - 8344 / P-6	Kırmızı	7.50	13.00	16.40	9.15	26.50	0.190	500

Dayanıklı Termoplastik hammaddeden imal edilmiş olup, UL 94 / V2 normunda 105C0 çalışma sıcaklığında, bina elektrik tesisatları için 600V, aydınlatma ve sinyalizasyon için 1000 V'a dayanabilme özelliğine sahiptir.



## VİDALI YAYLI BUAT KLEMENSLERİ (KULAKLI TİP)

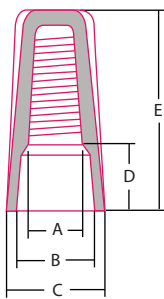

KOD	RENK	A	B	C	D	E	AD. / ʘ	K. / AD.
ONKA - 8345 P-11	Sarı	6.40	9.80	18.20	9.00	25.80	0.150	500
ONKA - 8346 P-12	Bej	7.20	11.60	18.30	9.20	29.00	0.180	500
ONKA - 8347 P-13	Kırmızı	9.00	13.50	23.00	9.60	31.80	0.210	500
ONKA - 8348 P-15	Gri	10.00	14.90	25.50	10.00	33.30	0.300	250
ONKA - 8349 P-17	Mavi	12.00	18.80	32.00	13.00	40.0	0.375	100

Dayanıklı Termoplastik hammaddeden imal edilmiş olup, UL 94 / V2 normunda 105C0 çalışma sıcaklığında, bina elektrik tesisatları için 600V, aydınlatma ve sinyalizasyon için 1000 V'a dayanabilme özelliğine sahiptir.



## YÜKSÜKLÜ BUAT KLEMENSİ (ŞEFFAF)

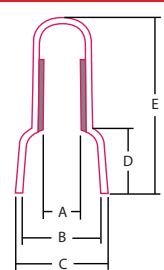

KOD	A	B	C	D	E	AD. / ʘ	K. / AD.
ONKA - 8330 CE-1	2.6	6.2	7.8	6.2	18.0	0.053	1000
ONKA - 8331 CE-2	3.1	7.9	9.5	7.2	19.7	0.060	1000
ONKA - 8332 CE-5	4.1	10.5	12.5	9.6	25.5	0.083	1000
ONKA - 8333 CE-8	5.3	12.4	14.6	12.0	27.7	0.270	500

Naylon 66 hammaddeden imal edilmiş olup, UL 94 / V2 normunda, 105 °C çalışma sıcaklığında 300 Volt Enerjiye Dayanabilme özelliğine sahiptir. (CE - 8) Modeli 600 Volt Enerjiye Dayanabilme.



## GEÇMELİ BUAT KLEMENSLER (RENKLİ VE ŞEFFAF)

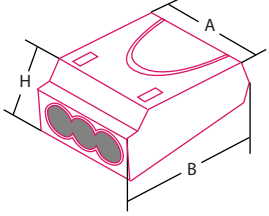
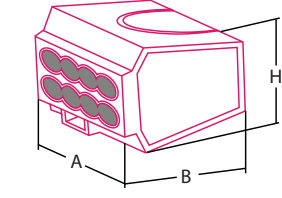

ŞEFFAF KOD	RENKLİ KOD	RENK	KABLO KESİTİ	A	B	H	AD. / ʘ	K. / AD.
ONKA - 8320	ONKA - 8339	2 (Kırmızı)	2.5	10.5	19.5	9.5	0.22	500
ONKA - 8321	ONKA - 8350	3 (Oranj)	2.5	13.5	19.7	9.5	0.29	500
ONKA - 8322	ONKA - 8351	4 (Sarı)	2.5	17.2	19.7	9.5	0.37	500
ONKA - 8323	ONKA - 8352	5 (Gri)	2.5	21.1	19.7	9.5	0.39	500
ONKA - 8463	ONKA - 8464	6 Beyaz	2.5	22.0	19.7	9.5	0.58	500
ONKA - 8324	ONKA - 8353	8 (Siyah)	2.5	17.5	19.0	16.8	0.89	250

Termoplastik hammaddeden imal edilmiş olup, UL 94 / V2 normunda, 105 °C çalışma sıcaklığında 600 volt elektrik iletkenliğine sahip 24 A akım geçirgenliğine sahiptir.



## UYGULAMA ŞEKLİ

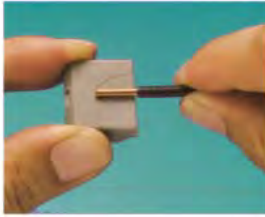

Kablo Boyu 11 mm olacak şekilde açınız.

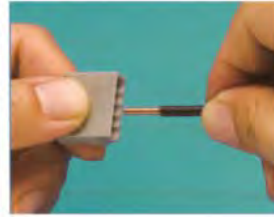

Kablo sıralamalarından emin olduktan sonra tüm kabloları sokete itiniz.



Bağlantının doğruluğunu test etmek için yuvayı, voltaj test aleti ile kontrol ediniz.



## PRATİK VE HIZLI KABLO EKLEME PARÇASI

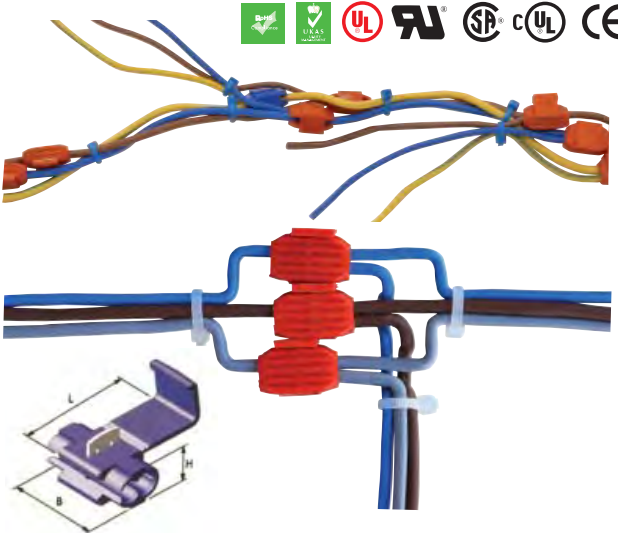

KOD	KABLO KESİTİ	B	H	L	AD. / ʘ	K. / AD.	
ONKA - 5175	SP-1	0.5 ~ 1.0	20.0	8.0	25.0	0.135	500
ONKA - 5176	SP-2	1.0 ~ 2.5	20.0	8.0	25.0	0.150	500
ONKA - 5177	SP-5	4.0 ~ 6.0	20.0	11.0	35.0	0.195	250

## PRATİK KLEMENSİN AVANTAJLARI

- Kablonun kesilip sıyrılmasına gerek yoktur.
- Vida gevşetip sıkılması gerekmez.
- İki kabloyu eklemek için kullanılabilir.
- Mevcut kablodan kesmeden ek almak için kullanılabilir.
- Bağlantıya ön hazırlık (yüyük ve lehim) gerektirmez.
- İzoleli bir pense yardımı ile enerji altında bile birleştirme yapılabilir.
- Bağlantı sonrası izolasyon gerektirmez.
- Aşırı akım çekildiği anda ısınma olsa bile alev almaz

- malzemenin ürettiğinden yanma riski (P6=105 °C)
- Estetik bir siva üstü tesisatlarda, görünür yerlerde bile kullanılabilir.
- Sıra klemensler ile aynı boyuttadır.
- Buat kutuları içerisinde güvenle kullanılabilir.
- Özel bir takım grubu kullanmayı gerektirmez.
- Birleştirilen kabloların gevşek kalma, aşırı sıkılmasından kaynaklanan problemler yaşanmaz.
- En önemlisi EKONOMİKTİR!

## 2273 SERİSİ BAĞLANTI KESİTLİ, TEK DAMAR İLETKENLER İÇİN BUAT KELEMENLER



0.5 mm<sup>2</sup>'den 2.5 mm<sup>2</sup>'ye kadar yepyeni bir BUAT KLEMENSİ

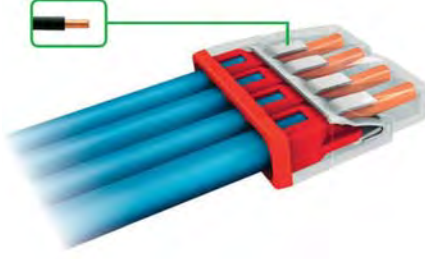

## 222 SERİSİ ÇOK AMAÇLI KONNEKTÖR (AÇ KAPA BUAT KLEMENLERİ)

KOD	NO	KABLO KESİTİ	AD. / ɸ	K. / AD.
ONKA - 8555	2	4	0.63	500
ONKA - 8556	3	4	0.83	500
ONKA - 8557	5	4	1.30	400

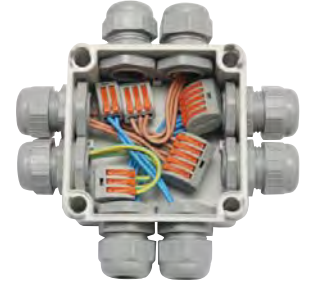

## 243 SERİSİ ZİL VE ZİL SESLENDİRME TESİSATI KONNEKTÖRLERİ

4 x 0.8 mm<sup>2</sup>  
8 x 0.8 mm<sup>2</sup>  
4'lü konnektörlük  
6'lı konnektörlük  
Raya monte edilebilen  
konnektörlük yuvaları  
üzerine monte  
edilebilirler.



## FİŞ PRİZ AYDINLATMA KONEKTÖRÜ

2 x 4 mm<sup>2</sup>  
0.75 mm<sup>2</sup>  
tek damar kablolar için  
kilitli



## KC TİP KABLO ETİKETLERİ (KABLOYA ÜSTTEN GEÇMELİ)

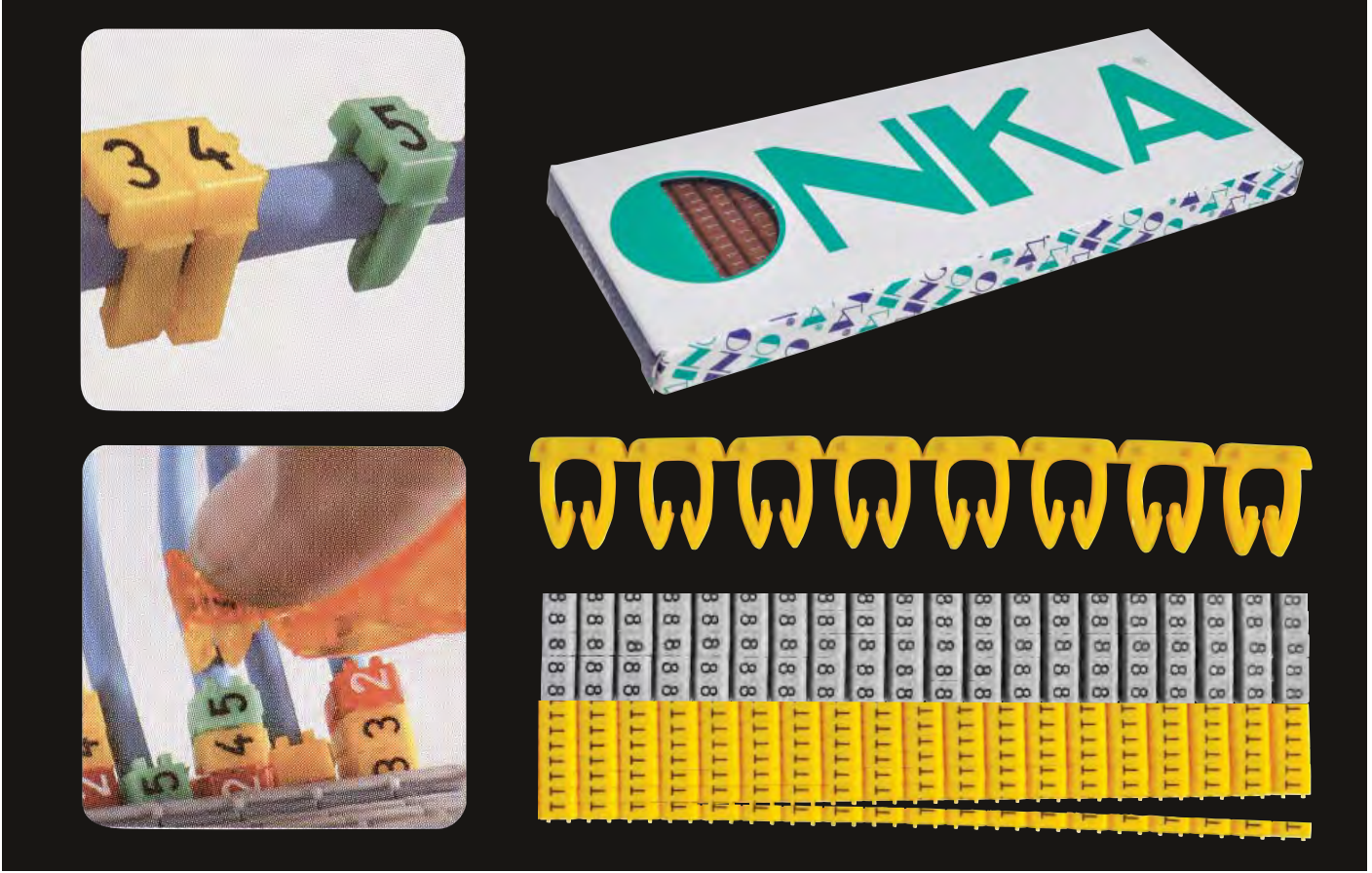

0  
1  
2  
3  
4  
5  
6  
7  
8  
9

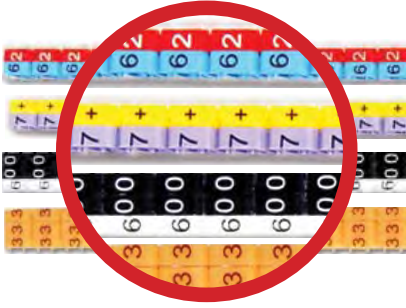

A P  
B R  
C S  
D T  
E U  
F V  
G W  
H X  
I Y  
J Z  
K Mp  
L +  
M -  
N ⚡  
O ~

## KC TİP KABLO NUMARALAMALARI (KABLOYA ÜSTTEN GEÇMELİ)

KOD	ÖLÇÜ	KUTU / ₺	KUTU / AD.	KOLİ / AD.
ONKA - 9850	0,50 x 1 mm <sup>2</sup> Rakam	6.50	400	20.000
ONKA - 9894	1,50 x 2,50 mm <sup>2</sup> Rakam	8.80	400	20.000
ONKA - 9942	4,0 x 6,00 mm <sup>2</sup> Rakam	10.00	400	20.000
ONKA - 9851	0,50 x 1 mm <sup>2</sup> Yazı	6.50	400	20.000
ONKA - 9895	1,50 x 2,50 mm <sup>2</sup> Yazı	8.80	400	20.000
ONKA - 9943	4,0 x 6,00 mm <sup>2</sup> Yazı	10.00	400	20.000

0  
1  
2  
3  
4  
5  
6  
7  
8  
9



U  
V  
W  
R  
S  
T  
N  
-  
+  
Mp  
⚡

## EC TİPİ KABLO NUMARALAMALARI (KABLOYA YANDAN GEÇMELİ)

KOD	ÖLÇÜ	KUTU / ₺	K. / AD.
KBG-EC 0	0,50 x 1,5 mm	11.00	1000
KBG-EC 1	1,50 x 6,0 mm	11.00	1000
KBG-EC 2	4,0 x 16,00 mm	11.00	500
KBG-EC 3	10 x 25 mm	11.00	250

Bant Özelliği 1 mm Kalınlık 120 °C 96 kg/m<sup>3</sup> yoğunluk



Tam Yapışkanlık max 60 dakika sonra

## KABLO BAĞI TUTUCULARI (YAPIŞKANLI VE VİDALI)

KOD	A	B	C	D	H	AD. / ʘ	K. AD.
ONKA - 8391 / 3A	19	3.6	19	Ø3.2	4.0	0.11	100
ONKA - 8392 / 4A	28	4.8	28	Ø3.2	4.5	0.16	100



## KABLO BAĞI ETİKET TAŞIYICI



KOD	EN	BOY	AD. / ʘ	POŞET AD.	KOLİ AD.
ONKA-8560	33	12	0.24	100	10.000
ONKA-8561	44	19	0.36	100	4.500



## KABLOLAR İÇİN İŞARETLEME ETİKET YATAĞI

KOD	A	AD. / ʘ	K. AD.
ONKA-7134	2.5 - 3.6 mm Kablo bağları ile bağlanabilir. DB5 mm Klemens etiketleri kullanılabilir. Şeffaf daralan makoronla tam izolasyon yapılabilir.	0.50	50



## METRELİK PANO ETİKETİ (YAPIŞKANLI)

KOD	A	AD. / ʘ	K. AD.
ONKA-7126	15 x 100 cm Yapışkanlı Pano Etiketi	9.90	50



## PANO ETİKETLERİ (YAPIŞKANLI VE VİDALI)



KOD	A	AD. / ʘ	K. AD.
ONKA-7114	17 x 30 mm Pano Etiketi	0.23	100
ONKA-7115	17 x 52 mm Pano Etiketi	0.35	100
ONKA-7116	17 x 70 mm Pano Etiketi	0.48	50

## W OTOMAT ÖRTME APARATI

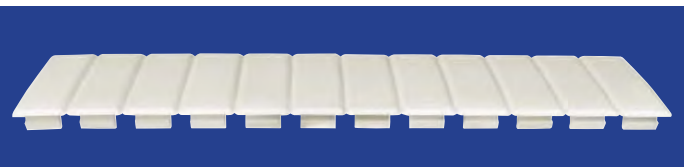

RENKLER  
RAL 9001 RAL 7035 RAL 7033

KOD	A	AD. / ʘ	K. AD.
ONKA 7121		1.42	50

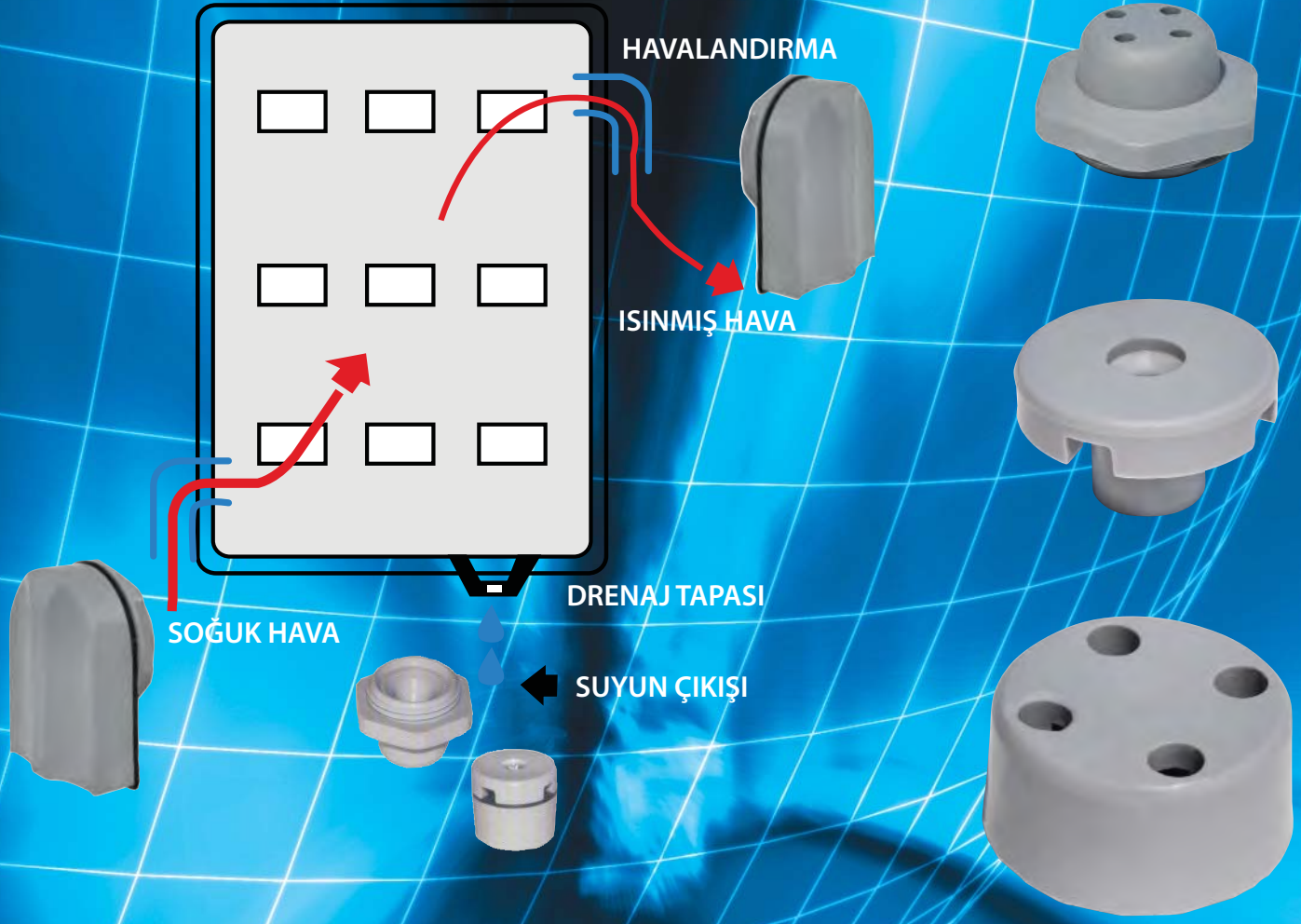

#### M40 x 1.5 PANO HAVALANDIRMA APARATI

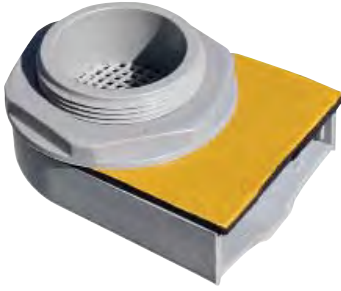

KOD	BOY	AD. / ʘ	K. AD.
● ONKA - 9500	M 40 x 1.5	2.95	50
● ONKA - 9501	M 40 x 1.5	2.95	50
● ONKA - 9502	M 40 x 1.5	2.95	50

#### M25 x 1.5 DRENAJ TAPASI



KOD	BOY	AD. / ʘ	K. AD.
● ONKA - 9510	25 x 1.5	0.45	100
● ONKA - 9511	25 x 1.5	0.45	100
● ONKA - 9512	25 x 1.5	0.45	100

#### Ø16 DRENAJ TAPASI



KOD	BOY	AD. / ʘ	K. AD.
● ONKA - 9520	M 16	0.50	100
● ONKA - 9521	M 16	0.50	100
● ONKA - 9522	M 16	0.50	100



Pollamid 6 ve 6.6 birer termoplastik polimerlerdir. Isıtıldıkları zaman yumuşar ve akar, soğutuldukları zaman sertleşir ve katılaşır. Bu, termoplastiklerin tekrar edilebilir bir özelliğidir. Pollamid 6.6'nın pollamid 6'ya bir takım üstünlükleri vardır. Bunları özetlersek;

– Pollamid 6.6 pollamid 6'ya göre daha yüksek ısısal dayanıma sahiptir.

Erime veya yumuşama noktası, yük altında deformasyon sıcaklığı ve maximum çalışma sıcaklığı daha yüksektir.

– Pollamid 6.6 pollamid 6'ya göre daha güçlü bir yapıya sahiptir.

Kopma mukavemeti, eğilme mukavemeti, darbe mukavemeti, yüksek aşınma mukavemeti, çekme eğilme ve basma elastiklik modülü daha yüksektir.

Tüm bu termal ve mekaniksel üstünlükler pollamid 6.6 ile üretilen ürünlerin dış ortam koşullarına pollamid 6'ya göre daha dayanıklı olduğunu göstermektedir.

ONKA Elektrik olarak bizler rakor ürünlerimizde pollamid 6.6'yı kullanıyoruz ve ürünlerimizin piyasada pollamid 6 ile üretim emsallerinden üstün olduğunu net bir şekilde kabul ediyoruz.

Renkler

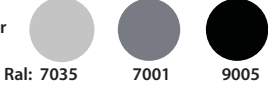

## IP-68 PG POLYAMİD KABLO RAKORU

KOD	BOY	MONTAJ ÇAPI	AD. / ʘ	K. / AD.	KOLİ / AD.
ONKA - 9000	PG-7	12.5	0.26	450	6750
ONKA - 9001	PG-9	15.5	0.29	300	4500
ONKA - 9002	PG-11	18.5	0.39	200	3000
ONKA - 9003	PG-13.5	20.5	0.41	175	2625
ONKA - 9004	PG-16	22.5	0.51	125	1875
ONKA - 9005	PG-21	28.5	0.75	75	1125
ONKA - 9006	PG-29	37.5	1.22	40	600
ONKA - 9007	PG-36	47.5	2.20	20	300
ONKA - 9008	PG-42	55.0	2.82	15	225
ONKA - 9009	PG-48	60.0	3.10	12	180

## PG POLYAMİD SOMUN

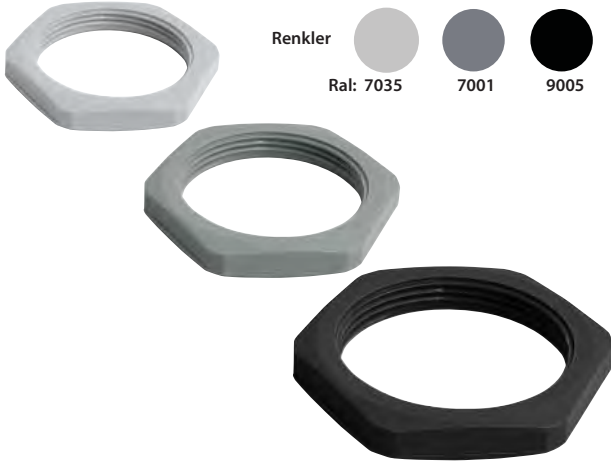

Renkler



KOD	BOY	MONTAJ DELİK	AD. / ʘ	K. / AD.
ONKA - 9070	PG-7	12.5	0.11	250
ONKA - 9071	PG-9	15.5	0.11	250
ONKA - 9072	PG-11	18.5	0.14	250
ONKA - 9073	PG-13.5	20.5	0.14	250
ONKA - 9074	PG-16	22.5	0.17	250
ONKA - 9075	PG-21	28.5	0.26	250
ONKA - 9076	PG-29	37.5	0.46	150
ONKA - 9077	PG-36	47.0	0.85	100
ONKA - 9078	PG-42	55.0	0.90	100
ONKA - 9079	PG-48	60.0	1.00	100

## IP-68 METRİK POLYAMİD KABLO RAKORU

Renkler



KOD	BOY	MONTAJ ÇAPI (mm)	AD. / ʘ	K. / AD.	KOLİ / AD.
ONKA - 9050	M 12 x 1.5	12	0.27	450	6750
ONKA - 9051	M 16 x 1.5	16	0.35	200	3000
ONKA - 9052	M 20 x 1.5	20	0.44	150	2250
ONKA - 9053	M 25 x 1.5	25	0.85	75	1125
ONKA - 9054	M 32 x 1.5	32	1.30	40	600
ONKA - 9055	M 40 x 1.5	40	2.15	20	300

## METRİK POLYAMİD SOMUN

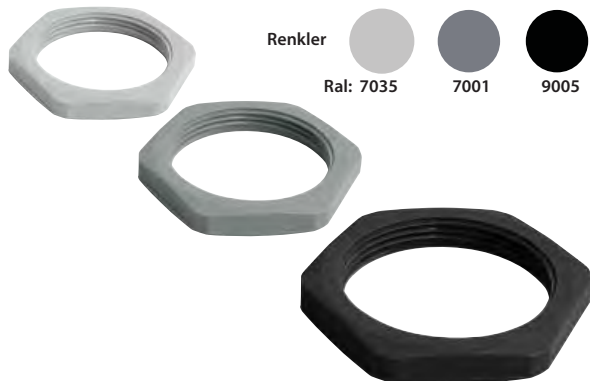

Renkler



KOD	BOY	MONTAJ DELİK	AD. / ʘ	K. / AD.
ONKA - 9010	M 12 x 1.5	12	0.13	250
ONKA - 9011	M 16 x 1.5	16	0.14	250
ONKA - 9012	M 20 x 1.5	20	0.18	250
ONKA - 9013	M 25 x 1.5	25	0.43	250
ONKA - 9014	M 32 x 1.5	32	0.44	250
ONKA - 9015	M 40 x 1.5	40	0.57	250



## PG SİRİAL KABLO REKORU



KOD	BOY	MONTAJ ÇAPI	AD. / ʘ	K. / AD.
ONKA - 9275	PG 7	12	0.54	200
ONKA - 9281	PG 11	16	0.84	150
ONKA - 9284	PG 13.5	20	0.90	100
ONKA - 9290	PG 21	25	1.87	75
ONKA - 9276	PG 7	12	0.54	200
ONKA - 9282	PG 11	16	0.84	150
ONKA - 9285	PG 13.5	20	0.90	100
ONKA - 9291	PG 21	25	1.87	75
ONKA - 9277	PG 7	12	0.54	200
ONKA - 9283	PG 11	16	0.84	150
ONKA - 9286	PG 13.5	20	0.90	100
ONKA - 9292	PG 21	25	1.87	75

## METRİK SİRİAL KABLO REKORU



KOD	BOY	MONTAJ ÇAPI	AD. / ʘ	K. / AD.
ONKA - 9475	M 12 x1.5	12	0.56	200
ONKA - 9478	M 16 x1.5	16	0.75	150
ONKA - 9481	M 20 x1.5	20	0.94	100
ONKA - 9484	M 25 x1.5	25	2.00	75
ONKA - 9476	M 12 x1.5	12	0.56	200
ONKA - 9479	M 16 x1.5	16	0.75	150
ONKA - 9482	M 20 x1.5	20	0.94	100
ONKA - 9485	M 25 x1.5	25	2.00	75
ONKA - 9477	M 12 x1.5	12	0.56	200
ONKA - 9480	M 16 x1.5	16	0.75	150
ONKA - 9483	M 20 x1.5	20	0.94	100
ONKA - 9486	M 25 x1.5	25	2.00	75

## PG POLYAMİD KÖRTAPA



KOD	BOY	MONT. DELİK	AD. / ʘ	K. / AD.
ONKA-9090	PG-7	12.5	0.17	250
ONKA-9091	PG-9	15.5	0.19	250
ONKA-9092	PG-11	18.5	0.20	250
ONKA-9093	PG-13.5	20.5	0.25	250
ONKA-9094	PG-16	22.5	0.31	250
ONKA-9095	PG-21	28.5	0.38	250
ONKA-9096	PG-29	37.5	0.64	150
ONKA-9097	PG-36	47.5	0.92	100

## KAUÇUK KÖRTAPA



KOD	BOY	MON. ÇAPI	AD. / ʘ	K. / AD.
ONKA-9020	PG-13.5	17	0.70	100
ONKA-9021	PG-16	22.8	0.85	100
ONKA-9022	PG-21	28.6	1.13	100
ONKA-9023	PG-29	37.3	1.42	100
ONKA-9024	PG-36	47	1.75	100
ONKA-9025	PG-42	55	2.90	50

## PANO TOPRAKLI PRİZLERİ



W 01

W 02

RMP01

KOD	CİNSİ	AD. / ₺	K. AD.
ONKA - W 01	Pano Topraklı Priz 35'lik Raya Montaj Tek Faz	8.50	1
ONKA - W 02	Pano Topraklı Priz 35'lik Raya Montaj Tek Faz (Fransız Modeli UPS)	9.00	1
ONKA - RMP01	Pano Topraklı Priz 35'lik Raya Montaj Tek Faz	15.00	1

## MONOFAZE 1 x 16 A KAPAKLI PANO PRİZLERİ



KOD	CİNSİ	AD. / ₺	K. AD.
ASG - AP2PN	1 x 16 A Pano Priz (Mavi kapak)	Ⓣ	50
MPP-1	1 x 16 A Pano Priz (Mavi kapak)	Ⓣ	10

## ELEKTRONİK PANO TERMOSTATI

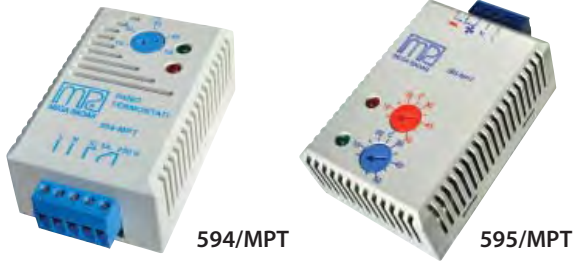

594/MPT

595/MPT

KOD	CİNSİ	AD. / \$	K. AD.
MEGA-594/MPT	Elektronik Pano Termostatı	11.50 \$	1
MEGA-595/MPT	Elektronik Pano Termostatı Soğuk-Sıcak Ayarlı	27.00 \$	1

## PANO İÇİ ISITMA VE SOĞUTMA TERMOSTATLARI



KOD	CİNSİ	AD. / €	K. AD.
PTHT	Pano İçi Isıtma Termostatı 0 - 60 C, NK, IP 20	8.00 €	1
PTVT	Pano İçi Soğutma Termostatı 0 - 60 C, NA, IP 20	8.00 €	1
PTVHT	Pano İçi Isıtma - Soğutma Termostatı 0 - 80 / 0-60 C, NA, IP 20	20.00 €	1
PHG12	Mekanik Higrostat %10/80 PH, 1CD, IP 20	45.00 €	1

## PANO ISITICILARI



KOD	CİNSİ	AD. / €	K. AD.
PHT 030	30 WPTC Pano Isıtıcısı	28.00 €	1
PHT 050	50 WPTC Pano Isıtıcısı	30.00 €	1
PHT 075	75 WPTC Pano Isıtıcısı	35.00 €	1
PHT 100	100 WPTC Pano Isıtıcısı	40.00 €	1
PHT 150	150 WPTC Pano Isıtıcısı	60.00 €	1
PFHT 250	250 W Fanlı Rezitans Pano Isıtıcısı	104.00 €	1
PFHT 500	500 W Fanlı Rezitans Pano Isıtıcısı	125.00 €	1
PFHT 750	750 W Fanlı Rezitans Pano Isıtıcısı	140.00 €	1



DIN 46228 Standartı,

Bakır Malzemedan Kalay Kaplı,

Polyamid İzoleli,

- 40 °C - 105 °C Çalışma Sıcaklığı



### POŞET SERİSİ İZOLELİ TEK GİRİŞLİ KABLO YÜKSÜKLERİ DIN 46228 (FRANSIZ, ALMAN)

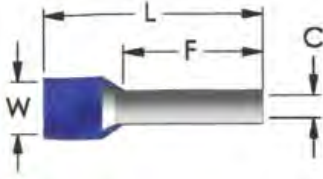

KOD	KABLO KESİTİ (mm <sup>2</sup> )	F	L	C	W	AD. / ʘ	K. AD.
ONKA - 8007 - P	0.50	8.0	14.00	1.0	2.6	0.018	500
ONKA - 8010 - P	0.75	8.0	14.00	1.2	2.8	0.018	500
ONKA - 8014 - P	1.0	8.0	14.00	1.4	3.0	0.019	500
ONKA - 8017 - P	1.5	8.0	14.00	1.7	3.5	0.020	500
ONKA - 8021 - P	2.5	8.0	14.00	2.2	4.2	0.025	500
ONKA - 8025 - P	4.0	10.0	17.00	2.8	4.8	0.043	500
ONKA - 8028 - P	6.0	12.0	20.00	3.5	6.3	0.055	500
ONKA - 8030 - P	10	12.0	22.00	4.5	7.6	0.072	500
ONKA - 8032 - P	16	12.0	24.00	5.8	8.8	0.115	500
ONKA - 8034 - P	25	16.0	30.00	7.3	11.2	0.216	500
ONKA - 8036 - P	35	16.0	30.00	8.3	12.7	0.289	500
ONKA - 8039 - P	50	20.0	36.00	10.3	15.0	0.419	500

### POŞET SERİSİ İZOLELİ ÇİFT GİRİŞLİ KABLO YÜKSÜKLERİ DIN 46228 (FRANSIZ, ALMAN)

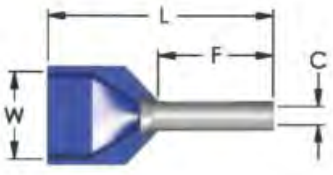

KOD	KABLO KESİTİ (mm <sup>2</sup> )	F	L	C	W	AD. / ʘ	K. AD.
ONKA - 8161-P	2 x 0.50	8.0	15.0	1.5	2.5/4.7	0.040	500
ONKA - 8162-P	2 x 0.75	8.0	15.0	1.8	2.8/5.0	0.043	500
ONKA - 8164-P	2 x 1	8.0	15.0	2.05	3.4/5.4	0.043	500
ONKA - 8166-P	2 x 1.5	8.0	16.0	2.3	3.6/6.6	0.046	500
ONKA - 8168-P	2 x 2.5	10.0	18.5	2.8	4.2/7.8	0.050	500
ONKA - 8170-P	2 x 4	12.0	23.0	3.7	4.9/8.8	0.130	500
ONKA - 8171-P	2 x 6	14.0	26.0	4.8	6.9/10.0	0.159	500
ONKA - 8172-P	2 x 10	14.0	26.5	6.4	7.6/12.8	0.325	500
ONKA - 8173-P	2 x 16	14.0	31.5	8.3	9.6/18.6	0.426	500

### POŞET SERİSİ İZOLESİZ KABLO YÜKSÜKLERİ DIN 46228

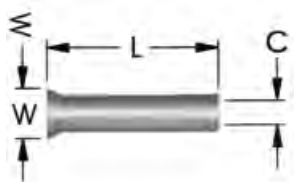

KOD	KABLO KESİTİ (mm <sup>2</sup> )	L	C	W	AD. / ʘ	K. AD.
ONKA - 8102 - P	0.50	10.0	1.0	2.1	0.019	1.000
ONKA - 8105 - P	0.75	10.0	1.2	2.3	0.019	1.000
ONKA - 8108 - P	1	10.0	1.4	2.5	0.019	1.000
ONKA - 8112 - P	1.5	10.0	1.7	2.8	0.021	1.000
ONKA - 8117 - P	2.5	12.0	2.2	3.4	0.026	1.000
ONKA - 8121 - P	4	12.0	2.8	4.0	0.036	1.000
ONKA - 8125 - P	6	12.0	3.5	4.7	0.044	1.000
ONKA - 8128 - P	10	12.0	4.5	5.8	0.065	1.000
ONKA - 8131 - P	16	12.0	5.8	7.5	0.081	1.000





DIN 46228 Standartı,  
Bakır Malzemedен Kalay Kaplı,  
Polyamid İzoleli,  
-40 OC - 105 °C Çalışma Sıcaklığı

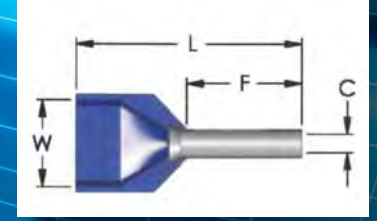

### KUTULU SERİ İZOLELİ ÇİFT GİRİŞLİ KABLO YÜKSÜKLERİ DIN 46228

RENK NORMLARI		
FRANSIZ	ALMAN	DIN

KOD	KABLO KESİTİ (mm <sup>2</sup> )	F	L	C	W	AD. / ʘ	K. AD.
ONKA - 8161	2 x 0.50	8.0	15.0	1.5	2.5 / 4.7	0.047	500
ONKA - 8162	2 x 0.75	8.0	15.0	1.8	2.8 / 5.0	0.051	500
ONKA - 8163	2 x 0.75	10.0	17.0	1.8	2.8 / 5.0	0.051	500
ONKA - 8164	2 x 1.0	8.0	15.0	2.05	3.4 / 5.4	0.051	500
ONKA - 8165	2 x 1.0	10.0	17.0	2.05	3.4 / 5.4	0.051	500
ONKA - 8166	2 x 1.5	8.0	16.0	2.3	3.6 / 6.6	0.054	500
ONKA - 8167	2 x 1.5	12.0	20.0	2.3	3.6 / 6.6	0.054	500
ONKA - 8168	2 x 2.5	10.0	18.5	2.8	4.2 / 7.8	0.058	200
ONKA - 8169	2 x 2.5	13.0	21.5	2.8	4.2 / 7.8	0.077	200
ONKA - 8170	2 x 4.0	12.0	23.0	3.7	4.9 / 8.8	0.153	100
ONKA - 8171	2 x 6.0	14.0	26.0	4.8	6.9 / 10.0	0.187	100
ONKA - 8172	2 x 10.0	14.0	26.5	6.4	7.6 / 12.8	0.382	50
ONKA - 8173	2 x 16.0	14.0	31.5	8.3	9.6 / 18.6	0.501	50



## KUTULU SERİ İZOLESİZ KABLO YÜKSÜKLERİ DIN 46228

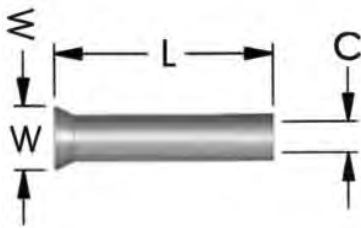

KOD	KABLO KESİTİ (mm <sup>2</sup> )	L	C	W	AD. / ʘ	K. AD.
ONKA - 8100	0.50	6.0	1.0	2.1	0.022	1.000
ONKA - 8101	0.50	8.0	1.0	2.1	0.022	1.000
ONKA - 8102	0.50	10.0	1.0	2.1	0.022	1.000
ONKA - 8103	0.75	6.0	1.2	2.3	0.022	1.000
ONKA - 8104	0.75	8.0	1.2	2.3	0.022	1.000
ONKA - 8105	0.75	10.0	1.2	2.3	0.022	1.000
ONKA - 8106	1.0	6.0	1.4	2.5	0.022	1.000
ONKA - 8107	1.0	8.0	1.4	2.5	0.022	1.000
ONKA - 8108	1.0	10.0	1.4	2.5	0.022	1.000
ONKA - 8109	1.0	12.0	1.4	2.5	0.024	1.000
ONKA - 8110	1.5	7.0	1.7	2.8	0.024	1.000
ONKA - 8111	1.5	8.0	1.7	2.8	0.024	1.000
ONKA - 8112	1.5	10.0	1.7	2.8	0.024	1.000
ONKA - 8113	1.5	12.0	1.7	2.8	0.025	1.000
ONKA - 8114	2.5	7.0	2.2	3.4	0.030	1.000
ONKA - 8115	2.5	8.0	2.2	3.4	0.030	1.000
ONKA - 8116	2.5	10.0	2.2	3.4	0.030	1.000
ONKA - 8117	2.5	12.0	2.2	3.4	0.032	1.000
ONKA - 8118	4.0	8.0	2.8	4.0	0.042	1000
ONKA - 8119	4.0	9.0	2.8	4.0	0.042	1000
ONKA - 8120	4.0	10.0	2.8	4.0	0.042	1000
ONKA - 8121	4.0	12.0	2.8	4.0	0.042	1000
ONKA - 8122	4.0	15.0	2.8	4.0	0.046	1000
ONKA - 8123	4.0	18.0	2.8	4.0	0.060	1000
ONKA - 8124	6.0	10.0	3.5	4.7	0.051	500
ONKA - 8125	6.0	12.0	3.5	4.7	0.051	500
ONKA - 8126	6.0	15.0	3.5	4.7	0.056	500
ONKA - 8127	6.0	18.0	3.5	4.7	0.066	500
ONKA - 8128	10.0	12.0	4.5	5.8	0.076	200
ONKA - 8129	10.0	15.0	4.5	5.8	0.076	200
ONKA - 8130	10.0	18.0	4.5	5.8	0.082	200
ONKA - 8131	16.0	12.0	5.8	7.5	0.084	100
ONKA - 8132	16.0	15.0	5.8	7.5	0.084	100
ONKA - 8133	16.0	18.0	5.8	7.5	0.096	100
ONKA - 8134	25.0	15.0	7.3	9.5	0.160	100
ONKA - 8135	25.0	16.0	7.3	9.5	0.160	100
ONKA - 8136	25.0	18.0	7.3	9.5	0.184	100
ONKA - 8137	25.0	22.0	7.3	9.5	0.208	100
ONKA - 8138	35.0	16.0	8.3	11.0	0.240	75
ONKA - 8139	35.0	18.0	8.3	11.0	0.240	75
ONKA - 8140	35.0	20.0	8.3	11.0	0.272	75
ONKA - 8141	35.0	25.0	8.3	11.0	0.312	75
ONKA - 8142	50.0	18.0	10.3	13.0	0.400	25
ONKA - 8143	50.0	20.0	10.3	13.0	0.400	25
ONKA - 8144	50.0	25.0	10.3	13.0	0.460	25
ONKA - 8145	70.0	22.0	13.5	15.3	0.760	10
ONKA - 8146	70.0	25.0	13.5	15.3	0.760	10
ONKA - 8147	70.0	32.0	13.5	15.3	0.900	10
ONKA - 8148	95.0	25.0	14.7	16.6	1.000	10
ONKA - 8149	95.0	32.0	14.7	16.6	1.100	10
ONKA - 8150	120.0	30.0	16.7	18.0	1.300	10
ONKA - 8151	120.0	32.0	16.7	18.0	1.300	10
ONKA - 8152	120.0	34.0	16.7	18.0	1.600	10
ONKA - 8153	150.0	32.0	19.5	21.5	1.800	10
ONKA - 8154	150.0	38.0	19.5	21.5	2.000	10

DIN 46228 Standartı,  
Bakır Malzemeden Kalay Kaplı,



DIN 46237 Standartı,  
Bakır Malzemeden Kalay Kaplı,  
PVC İzoleli,  
105 °C Çalışma Sıcaklığı,  
600 Volt Enerjiye Dayanabilme.

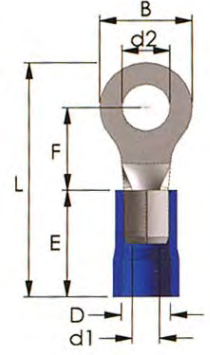

### İZOLELİ YUVARLAK KABLO UÇLARI



0,5 ~ 1,5 mm<sup>2</sup>, Kablo Kesiti

KOD	METRİK ÖLÇÜ (d2)	B	L	F	E	D	d1	AD. / ı	K. AD.
ONKA-8045 -R1-3 V	3.2	5.5	16.7	4.0	10.0	4.1	1.7	0.062	200
ONKA-8046-R1-3.5 SV	3.7	5.5	16.7	4.0	10.0	4.1	1.7	0.068	200
ONKA-8047-R1-3.5 MV	3.7	6.6	19.6	6.3	10.0	4.1	1.7	0.068	200
ONKA-8048-R1-3.5 LV	3.7	8.0	21.0	7.0	10.0	4.1	1.7	0.080	200
ONKA-8049-R1-4 SV	4.3	6.6	19.6	6.3	10.0	4.1	1.7	0.080	200
ONKA-8050-R1-4 LV	4.3	8.0	21.0	7.0	10.0	4.1	1.7	0.084	200
ONKA-8051-R1-5 V	5.3	8.0	21.0	7.0	10.0	4.1	1.7	0.087	200
ONKA-8052-R1-6 V	6.5	11.6	26.8	11.1	10.0	4.1	1.7	0.110	200
ONKA-8053-R1-8 V	8.4	11.6	26.8	11.1	10.0	4.1	1.7	0.116	200
ONKA-8054-R1-10 V	10.5	13.6	30.7	13.9	10.0	4.1	1.7	0.132	100
ONKA-8055-R1-12 V	13	19.2	35.6	16.0	10.0	4.1	1.7	0.217	100



1,5 ~ 2,5 mm<sup>2</sup>, Kablo Kesiti

ONKA-8056-R2-3 V	3.2	6.4	17.5	4.3	10.0	4.5	2.3	0.084	200
ONKA-8057-R2-3.5 SV	3.7	6.4	17.5	4.3	10.0	4.5	2.3	0.093	200
ONKA-8058-R2-3.5 MV	3.7	6.6	19.5	6.3	10.0	4.5	2.3	0.093	200
ONKA-8059-R2-3.5 LV	3.7	8.5	22.0	7.8	10.0	4.5	2.3	0.093	200
ONKA-8060-R2-4 SV	4.3	6.6	19.5	6.3	10.0	4.5	2.3	0.100	200
ONKA-8086-R2-4 LV	4.3	8.5	22.0	7.8	10.0	4.5	2.3	0.100	200
ONKA-8087-R2-5 SV	5.3	8.5	22.0	7.8	10.0	4.5	2.3	0.100	200
ONKA-8088-R2-5 LV	5.3	9.5	22.0	7.3	10.0	4.5	2.3	0.104	200
ONKA-8089-R2-6 V	6.5	12.0	27.0	11.0	10.0	4.5	2.3	0.124	200
ONKA-8090-R2-8 V	8.4	12.0	27.0	11.0	10.0	4.5	2.3	0.127	200
ONKA-8091-R2-10 V	10.5	13.6	30.7	13.9	10.0	4.5	2.3	0.163	100
ONKA-8092-R2-12 V	13.0	19.2	35.6	16.0	10.0	4.5	2.3	0.279	100



4,0 ~ 6,0 mm<sup>2</sup>, Kablo Kesiti

ONKA-8093-R5-4 SV	4.3	7.2	22.0	5.9	12.5	6.5	3.4	0.163	75
ONKA-8094-R5-4 LV	4.3	9.5	25.5	8.3	12.5	6.5	3.4	0.170	75
ONKA-8095-R5-5 V	5.3	9.5	25.5	8.3	12.5	6.5	3.4	0.170	75
ONKA-8096-R5-6 V	6.5	12.0	29.0	10.5	12.5	6.5	3.4	0.186	75
ONKA-8097-R5-8 V	8.4	15.0	33.7	13.7	12.5	6.5	3.4	0.232	75
ONKA-8098-R5-10 V	10.5	15.0	33.7	13.7	12.5	6.5	3.4	0.240	75
ONKA-8099-R5-12 V	13.0	19.2	38.1	16.0	12.5	6.5	3.4	0.287	75



8,0 ~ 10,0 mm<sup>2</sup>, Kablo Kesiti

ONKA-8158-R8-4 LV	4.3	12.0	32.5	9.7	17.0	8.0	4.5	0.450	50
ONKA-8159-R8-5 MV	5.3	12.0	32.5	9.7	17.0	8.0	4.5	0.450	50
ONKA-8160-R8-6 SV	6.7	12.0	32.5	9.7	17.0	8.0	4.5	0.495	50
ONKA-8174-R8-5 LV	5.3	15.0	38.0	13.8	17.0	8.0	4.5	0.495	50
ONKA-8175-R8-6 LV	6.7	15.0	38.0	13.8	17.0	8.0	4.5	0.525	50
ONKA-8176-R8-8 V	8.4	15.0	38.0	13.8	17.0	8.0	4.5	0.550	50
ONKA-8177-R8-10 V	10.5	15.0	38.0	13.8	17.0	8.0	4.5	0.565	50





DIN 46237 Standartı,  
Bakır Malzemeden Kalay Kaplı,  
PVC İzoleli,  
105 °C Çalışma Sıcaklığı,  
600 Volt Enerjiye Dayanabilme.



## İZOLELİ ÇATAL TİP KABLO UÇLARI



0,5 ~ 1,5 mm<sup>2</sup>, Kablo Kesiti

KOD	METRİK ÖLÇÜ (d2)	B	L	F	E	D	d1	AD. / ı	K. AD.
ONKA - 8061-3 V	3.2	5.8	21.0	6.3	10.0	4.1	1.7	0.077	200
ONKA - 8062-3.5 SV	3.7	6.4	20.6	6.3	10.0	4.1	1.7	0.077	200
ONKA - 8063-3.5 LV	3.7	7.2	21.0	6.3	10.0	4.1	1.7	0.077	200
ONKA - 8064-4 SV	4.3	6.4	20.6	6.3	10.0	4.1	1.7	0.084	200
ONKA - 8065-4 MV	4.3	7.2	21.0	6.3	10.0	4.1	1.7	0.084	200
ONKA - 8066-5 SV	5.3	8.0	21.0	7.0	10.0	4.1	1.7	0.088	200
ONKA - 8067-5 LV	5.3	9.5	21.0	7.0	10.0	4.1	1.7	0.090	200
ONKA - 8068-6 LV	6.5	12.0	27.2	11.0	10.0	4.1	1.7	0.910	200
ONKA - 8069-8 V	8.4	12.0	27.2	11.0	10.0	4.1	1.7	0.124	100
ONKA-8054-R1-10 V	10.5	13.6	30.7	13.9	10.0	4.1	1.7	0.135	100
ONKA-8055-R1-12 V	13	19.2	35.6	16.0	10.0	4.1	1.7	0.150	100



1,5 ~ 2,5 mm<sup>2</sup>, Kablo Kesiti

ONKA - 8070-3 V	3.2	5.8	21.0	6.3	10.0	4.5	2.3	0.087	200
ONKA - 8071-3.5 MV	3.7	6.4	21.0	6.3	10.0	4.5	2.3	0.087	200
ONKA - 8072-4 SV	4.3	6.4	21.0	6.3	10.0	4.5	2.3	0.087	200
ONKA - 8073-4 MV	4.3	7.2	21.2	6.5	10.0	4.5	2.3	0.089	200
ONKA - 8074-5 LV	5.3	9.5	22.0	7.2	10.0	4.5	2.3	0.104	200
ONKA - 8075-6 LV	6.5	12.0	27.2	11.0	10.0	4.5	2.3	0.140	200
ONKA - 8076-8 V	8.4	12.0	27.2	11.0	10.0	4.5	2.3	0.145	100



4,0 ~ 6,0 mm<sup>2</sup>, Kablo Kesiti

ONKA - 8077-4 SV	4.3	8.5	25.2	7.5	12.5	6.5	3.4	0.154	75
ONKA - 8078-4 LV	4.3	9.5	25.2	7.5	12.5	6.5	3.4	0.154	75
ONKA - 8079-5 V	5.3	9.5	25.2	7.5	12.5	6.5	3.4	0.168	75
ONKA - 8080-6 SV	6.5	9.5	25.2	7.5	12.5	6.5	3.4	0.186	75
ONKA - 8081-6 LV	6.5	12.0	31.2	12.0	12.5	6.5	3.4	0.230	75
ONKA - 8082-8 V	8.4	13.5	30.0	10.5	12.5	6.5	3.4	0.270	75



8.0 ~ 10.0 mm<sup>2</sup>, Kablo Kesiti

M: Medium

ONKA - 8083-40	4.3	8.2	29.0	8.1	17.0	8.0	4.5	0.410	50
ONKA - 8084-50	5.3	9.0	29.0	8.1	17.0	8.0	4.5	0.410	50
ONKA - 8085-60	6.5	10.8	30.5	8.6	17.0	8.0	4.5	0.450	50

S: Smal

M: Medium

L: Large

## İĞNE TİP PVC İZOLELİ KABLO UÇLARI

0,5 ~ 1,5 mm<sup>2</sup>, Kablo Kesiti1,5 ~ 2,5 mm<sup>2</sup>, Kablo Kesiti4,0 ~ 6,0 mm<sup>2</sup>, Kablo Kesiti

KOD	B	L	F	E	D	d1	AD. / ʘ	K. AD.
ONKA-8186-PT1-10V	1.9	20.5	10.5	10.0	4.1	1.7	0.090	200
ONKA-8187-PT2-10V	1.9	20.5	10.5	10.0	4.5	2.3	0.099	200
ONKA-8188-PT2-12V	1.9	22.5	12.5	10.0	4.5	2.3	0.108	200
ONKA-8189-PT2-18V	1.9	28.5	18.5	10.0	4.5	2.3	0.165	200
ONKA-8190-PT5-13V	2.8	26.2	13.7	12.5	6.5	3.4	0.150	100



Bakır Malzemededen, Kalay Kaplı, PVC İzoleli, 75 °C Çalışma Sıcaklığı, 600 Volt Enerjiye Dayanabilme.

## BIÇAK TİP PVC İZOLELİ KABLO UÇLARI

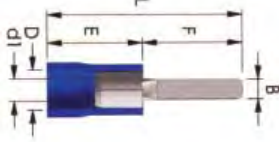
0,5 ~ 1,5 mm<sup>2</sup>, Kablo Kesiti1,5 ~ 2,5 mm<sup>2</sup>, Kablo Kesiti4,0 ~ 6,0 mm<sup>2</sup>, Kablo Kesiti

KOD	B	L	F	E	D	d1	AD. / ʘ	K. AD.
ONKA-8191-BT1-10A	2.4	21.5	10.5	11.0	4.1	1.7	0.140	100
ONKA-8192-BT1-14A	3.0	22.0	11.0	11.0	4.1	1.7	0.154	100
ONKA-8193-BT1-18A	3.0	25.0	14.0	11.0	4.1	1.7	0.238	100
ONKA-8194-BT2-9A	2.8	20.0	9.0	11.0	4.5	2.3	0.195	100
ONKA-8195-BT2-18A	2.4	29.0	18.0	11.0	4.5	2.3	0.195	100
ONKA-8196-PT5-13V	3.0	31.0	18.0	13.0	6.5	3.4	0.420	100

Bakır Malzemededen,  
Kalay Kaplı, Naylon İzoleli,  
105 °C Çalışma Sıcaklığı,  
600 Volt Enerjiye  
Dayanabilme.

## İZOLELİ KURŞUN ERKEK KABLO UCU

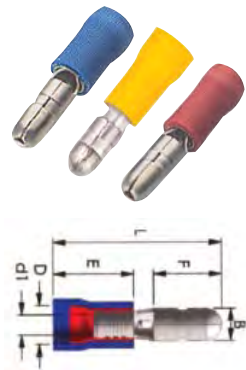
0,5 ~ 1,5 mm<sup>2</sup>, Kablo Kesiti1,5 ~ 2,5 mm<sup>2</sup>, Kablo Kesiti4,0 ~ 6,0 mm<sup>2</sup>, Kablo Kesiti

KOD	B	F	L	E	D	d1	AD. / ʘ	K. AD.
ONKA-8200-BD1-4VD	4.0	8.5	21.0	10.0	4.3	1.7	0.100	100
ONKA-8201-BD2-4VD	4.0	8.5	21.0	10.0	4.3	2.3	0.105	100
ONKA-8202-BD2-5VD	5.0	8.5	21.0	10.0	5.0	2.3	0.110	100
ONKA-8203-BD5-5VD	5.0	8.5	23.5	13.0	6.5	3.4	0.185	100



Bakır Malzemededen, Kalay Kaplı, PVC İzoleli, 75 °C Çalışma Sıcaklığı, 600 Volt Enerjiye Dayanabilme.

## FULL İZOLELİ KURŞUN DIŞI KABLO UCU

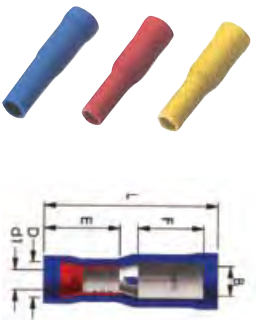
0,5 ~ 1,5 mm<sup>2</sup>, Kablo Kesiti1,5 ~ 2,5 mm<sup>2</sup>, Kablo Kesiti4,0 ~ 6,0 mm<sup>2</sup>, Kablo Kesiti

KOD	B	F	L	E	D	d1	AD. / ʘ	K. AD.
ONKA-8210-RE1-4VFD	4.0	9.0	23.5	11.0	4.3	1.7	0.145	100
ONKA-8211-RE2-4VFD	4.0	9.0	23.5	11.0	5.0	2.3	0.145	100
ONKA-8212-RE2-5VFD	5.0	9.0	23.5	11.0	5.0	2.3	0.145	100
ONKA-8213-RE5-5VFD	5.0	9.0	25.0	13.0	6.5	3.4	0.220	100



Bakır Malzemededen, Kalay Kaplı, PVC İzoleli, 75 °C Çalışma Sıcaklığı, 300 Volt Enerjiye Dayanabilme.



Pirinç Malzemededen  
Kalay Kaplı, PVC İzoleli,  
75 °C Çalışma Sıcaklığı,  
300 Volt Enerjiye Dayanabilme.



## İZOLELİ EK MUFLAR

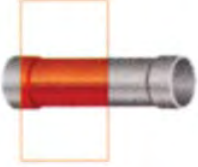

KOD	KABLO KESİTİ (mm <sup>2</sup> )	L	d	D	AD. / ʘ	K. AD.
ONKA-8215-BB 1V	0,5 - 1,5	26.0	1.7	4.1	0.090	200
ONKA-8216-BB 2V	1,5 - 2,5	26.0	2.3	4.5	0.099	200
ONKA-8217-BB 5V	4,0 - 6,0	27.0	3.4	6.5	0.165	100



Bakır Malzemededen  
Kalay Kaplı, Naylon İzoleli,  
150 °C Çalışma Sıcaklığı,  
600 Volt Enerjiye Dayanabilme.

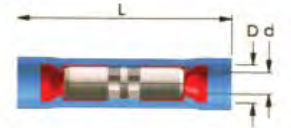

## İZOLELİ ŞEFFAF EK MUFLAR

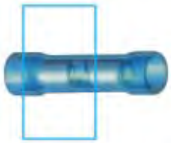

KOD	KABLO KESİTİ (mm <sup>2</sup> )	L	d	D	AD. / ʘ	K. AD.
ONKA-8220-BC 1A	0,5 - 1,5	26.0	1.8	4.2	0.105	200
ONKA-8221-BC 2A	1,5 - 2,5	26.0	2.4	4.8	0.120	200
ONKA-8222-BC 5A	4,0 - 6,0	27.0	3.6	4.8	0.180	100

Pirinç Malzemededen Kalay Kaplı,  
PVC İzoleli,  
105 °C Çalışma Sıcaklığı, 300  
Volt Enerjiye Dayanabilme.

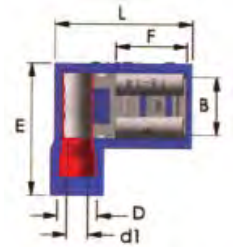

EXTRA ÇİFT YÜKSÜKLÜ

## İZOLELİ BAYRAK TİP KABLO UCU



KOD	SOKET GENİŞLİĞİ	B	L	F	E	D	d1	AD. / ʘ	K. AD.
ONKA-8225-FL1-6.4AC	0.8 x 6.4	6.6	7.9	16.1	15.0	4.5	1.7	0.270	100
ONKA-8226-FL2-6.4AC	0.8 x 6.4	6.6	7.9	16.1	15.0	4.5	1.7	0.290	100



Pirinç Malzemeden Kalay Kaplı,  
PVC İzoleli,  
75 °C Çalışma Sıcaklığı,  
300 Volt Enerjiye Dayanabilme.

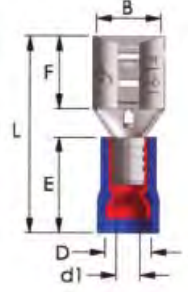

EXTRA ÇİFT YÜKSÜKLÜ



### İZOLELİ FATSON DIŞI KABLO UCU



0,5 ~ 1,5 mm<sup>2</sup>, Kablo Kesiti



1,5 ~ 2,5 mm<sup>2</sup>, Kablo Kesiti



4,0 ~ 6,0 mm<sup>2</sup>, Kablo Kesiti

KOD	SOKET GENİŞLİĞİ	B	F	L	E	D	d1	AD. / ʘ	K. AD.
ONKA - 8230-F1-2.8 VD/5	0.5 x 2.8	3.2	6.4	18.5	10.0	4.3	1.7	0.112	200
ONKA - 8231-F1-2.8 VD/8	0.8 x 2.8	3.2	6.4	18.5	10.0	4.3	1.7	0.112	200
ONKA - 8232-F1-4.8 VD/5	0.5 x 4.8	5.0	6.5	19.0	10.0	4.3	1.7	0.112	200
ONKA - 8233-F1-4.8 VD/8	0.8 x 4.8	5.0	6.5	19.0	10.0	4.3	1.7	0.112	200
ONKA - 8234-F1-6.4 VD	0.8 x 6.4	6.6	7.9	21.0	10.0	4.3	1.7	0.128	200
ONKA - 8235-F1-8 VD	0.8 x 8.0	8.4	10.0	24.0	10.0	4.3	1.7	0.175	200

ONKA - 8236-F2-2.8 VD/5	0.5 x 2.8	3.2	6.4	18.5	10.0	5.0	2.3	0.120	150
ONKA - 8237-F2-2.8 VD/8	0.8 x 2.8	3.2	6.4	18.5	10.0	5.0	2.3	0.105	150
ONKA - 8238-F2-4.8 VD/5	0.5 x 4.8	5.0	6.5	19.0	10.0	5.0	2.3	0.120	150
ONKA - 8239-F2-4.8 VD/8	0.8 x 4.8	5.0	6.5	19.0	10.0	5.0	2.3	0.120	150
ONKA - 8240-F2-6.4 VD	0.8 x 6.4	6.6	7.9	21.0	10.0	5.0	2.3	0.128	150
ONKA - 8241-F2-8 VD	0.8 x 8.0	8.4	10.0	24.0	10.0	5.0	2.3	0.184	150
ONKA - 8242-F2-9.5 VD	1.2 x 9.5	9.5	12.5	29.0	10.0	5.0	2.3	0.240	150

ONKA - 8243-F5-6.4 VD	0.8 x 6.4	6.6	7.9	23.5	12.5	6.5	3.4	0.195	100
ONKA - 8244-F5-9.5VD	1.2 x 9.5	9.9	12.5	28.5	12.5	6.5	3.4	0.368	100



Pirinç Malzemeden Kalay Kaplı,  
PVC İzoleli,  
75 °C Çalışma Sıcaklığı,  
300 Volt Enerjiye Dayanabilme.

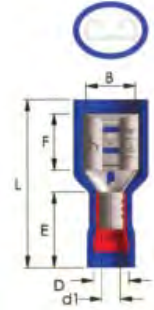

EXTRA ÇİFT YÜKSÜKLÜ



### FULL İZOLELİ FATSON DIŞI KABLO UCU



0,5 ~ 1,5 mm<sup>2</sup>, Kablo Kesiti



1,5 ~ 2,5 mm<sup>2</sup>, Kablo Kesiti



4,0 ~ 6,0 mm<sup>2</sup>, Kablo Kesiti

KOD	SOKET GENİŞLİĞİ	B	F	L	E	D	d1	AD. / ʘ	K. AD.
ONKA - 8250-F1-2.8 VFD-5	0.5 x 2.8	3.2	6.4	19.0	10.0	4.3	1.7	0.135	200
ONKA - 8251-F1-2.8 VFD-8	0.8 x 2.8	3.2	6.4	19.0	10.0	4.3	1.7	0.135	200
ONKA - 8252-F1-4.8 VFD-5	0.5 x 4.8	5.0	6.5	20.0	10.0	4.3	1.7	0.135	200
ONKA - 8253-F1-4.8 VFD-8	0.8 x 4.8	5.0	6.5	20.0	10.0	4.3	1.7	0.135	200
ONKA - 8254-F1-6.4 VFD	0.8 x 6.4	6.6	7.9	22.0	10.0	4.3	1.7	0.142	100

ONKA - 8255-F2-2.8 VFD-5	0.5 x 2.8	3.2	6.4	19.0	10.0	5.0	2.3	0.142	100
ONKA - 8256-F2-2.8 VFD-5	0.8 x 2.8	3.2	6.4	19.0	10.0	5.0	2.3	0.142	100
ONKA - 8257-F2-4.8 VFD-5	0.5 x 4.8	5.0	6.5	20.0	10.0	5.0	2.3	0.142	100
ONKA - 8258-F2-4.8 VFD-5	0.8 x 4.8	5.0	6.5	20.0	10.0	5.0	2.3	0.142	100
ONKA - 8259-F2-6.4 VFD	0.8 x 6.4	6.6	7.9	22.0	10.0	5.0	2.3	0.142	100

ONKA - 8260-F5-6.4 VFD	0.8 x 6.4	6.6	7.9	25.0	13.0	6.5	3.4	0.210	75
------------------------	-----------	-----	-----	------	------	-----	-----	-------	----

Pirinç Malzemededen Kalay Kaplı,  
Naylon İzoleli,  
105 °C Çalışma Sıcaklığı,  
300 Volt Enerjiye Dayanabilme.

**EXTRA ÇİFT YÜKSÜKLÜ**

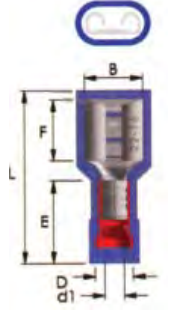

## FULL İZOLELİ POLYAMİD DİŞİ FATSON KABLO UÇLARI



0,5 ~ 1,5 mm<sup>2</sup>, Kablo Kesiti

KOD	SOKET GENİŞLİĞİ	B	F	L	E	D	d1	AD. / ʘ	K. AD.
ONKA - 8261-FF1-6.4 AFC	0.8 x 6.4	6.6	7.9	22.0	10.5	4.2	1.7	0.210	200



1,5 ~ 2,5 mm<sup>2</sup>, Kablo Kesiti

ONKA - 8262-FF2-6.4 AFC	0.8 x 6.4	6.6	7.9	22.0	10.5	4.9	2.3	0.225	100
-------------------------	-----------	-----	-----	------	------	-----	-----	-------	-----



4,0 ~ 6,0 mm<sup>2</sup>, Kablo Kesiti

ONKA - 8263-FF5-6.4 AFC	0.8 x 6.4	6.6	7.9	24.5	13.0	6.5	3.4	0.295	100
-------------------------	-----------	-----	-----	------	------	-----	-----	-------	-----



Pirinç Malzemededen Kalay Kaplı,  
PVC İzoleli,  
75 °C Çalışma Sıcaklığı,  
300 Volt Enerjiye Dayanabilme.

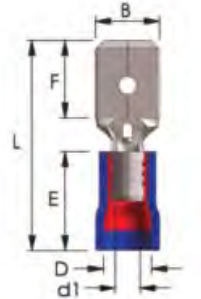

**EXTRA ÇİFT YÜKSÜKLÜ**

## FULL İZOLELİ FATSON DİŞİ KABLO UCU



0,5 ~ 1,5 mm<sup>2</sup>, Kablo Kesiti

KOD	SOKET GENİŞLİĞİ	B	F	L	E	D	d1	AD. / ʘ	K. AD.
ONKA - 8264-M1 - 5 C	0.5 x 2.8	2.8	7.0	19.2	10.0	4.3	1.7	0.126	100
ONKA - 8265-M1 - 8 C	0.8 x 2.8	2.8	7.8	20.5	10.0	4.3	1.7	0.115	100
ONKA - 8266-M1 - 5 C	0.5 x 4.8	4.8	7.0	19.2	10.0	4.3	1.7	0.135	100
ONKA - 8267-M1 - 8 C	0.8 x 4.8	4.8	7.8	20.5	10.0	4.3	1.7	0.117	100
ONKA - 8268	0.8 x 6.4	6.4	7.8	21.2	10.0	4.3	1.7	0.126	100



1,5 ~ 2,5 mm<sup>2</sup>, Kablo Kesiti

ONKA - 8269-M2 - 5 C	0.5 x 2.8	2.8	7.0	19.2	10.0	5.0	2.3	0.126	100
ONKA - 8270-M2 - 8 C	0.8 x 2.8	2.8	7.8	20.5	10.0	5.0	2.3	0.117	100
ONKA - 8271-M2 - 5 C	0.5 x 4.8	4.8	7.0	19.2	10.0	5.0	2.3	0.135	100
ONKA - 8272-M2 - 8 C	0.8 x 4.8	4.8	7.8	20.5	10.0	5.0	2.3	0.126	100
ONKA - 8273	0.8 x 6.4	6.4	7.8	21.2	10.0	5.0	2.3	0.129	100



4,0 ~ 6,0 mm<sup>2</sup>, Kablo Kesiti

ONKA - 8274-M5 - 6.4	0.8 x 6.4	6.4	7.8	23.7	12.5	6.5	3.4	0.187	100
----------------------	-----------	-----	-----	------	------	-----	-----	-------	-----

Pirinç Malzemeden Kalay Kaplı,  
PVC İzoleli,  
75 °C Çalışma Sıcaklığı,  
300 Volt Enerjiye Dayanabilme.

EXTRA ÇİFT YÜKSÜKLÜ

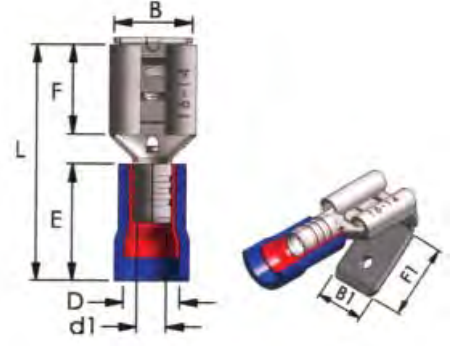

### ERKEK GERİ DÖNÜŞLÜ DIŞI KABLO UCU



0,5 ~ 1,5 mm<sup>2</sup>, Kablo Kesiti

KOD	SOKET GENİŞLİĞİ	B	B1	F	F1	L	E	D	d1	AD. / ʘ	K. AD.
ONKA - 8280-PB1 VD	0.8 x 6.4	6.6	6.4	8.0	8.2	21.0	10.0	4.3	1.7	0.170	100



1,5 ~ 2,5 mm<sup>2</sup>, Kablo Kesiti

ONKA - 8281-PB2 VD	0.8 x 6.4	6.6	6.4	8.0	8.2	21.0	10.0	5.0	2.3	0.210	100
--------------------	-----------	-----	-----	-----	-----	------	------	-----	-----	-------	-----



4,0 ~ 6,0 mm<sup>2</sup>, Kablo Kesiti

ONKA - 8282-PB5 VD	0.8 x 6.4	6.6	6.4	8.0	8.2	23.5	12.5	6.5	3.4	0.240	50
--------------------	-----------	-----	-----	-----	-----	------	------	-----	-----	-------	----



Pirinç Malzemeden Kalay Kaplı,  
PVC İzoleli,  
75 °C Çalışma Sıcaklığı,  
300 Volt Enerjiye Dayanabilme.

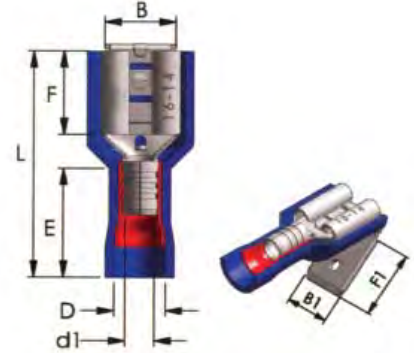

EXTRA ÇİFT YÜKSÜKLÜ

### FUL İZOLELİ ERKEK GERİ DÖNÜŞLÜ DIŞI KABLO UCU



0,5 ~ 1,5 mm<sup>2</sup>, Kablo Kesiti

KOD	SOKET GENİŞLİĞİ	B	B1	F	F1	L	E	D	d1	AD. / ʘ	K. AD.
ONKA-8285-PB1 VFD	0.8 x 6.4	6.6	6.4	8.0	8.2	22.0	10.0	4.3	1.7	0.225	100



1,5 ~ 2,5 mm<sup>2</sup>, Kablo Kesiti

ONKA-8286-PB2 VFD	0.8 x 6.4	6.6	6.4	8.0	8.2	22.0	10.0	5.0	2.3	0.240	100
-------------------	-----------	-----	-----	-----	-----	------	------	-----	-----	-------	-----



4,0 ~ 6,0 mm<sup>2</sup>, Kablo Kesiti

ONKA - 8282-PB5 VD	0.8 x 6.4	6.6	6.4	8.0	8.2	25.0	13.0	6.5	3.4	0.270	50
--------------------	-----------	-----	-----	-----	-----	------	------	-----	-----	-------	----

Pirinç Malzemededen Kalay Kaplı,  
PVC İzoleli,  
75 °C Çalışma Sıcaklığı,  
300 Volt Enerjiye Dayanabilme.

EXTRA ÇİFT YÜKSÜKLÜ

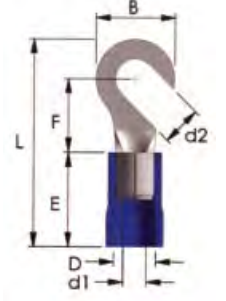

## ÇENGEL İZOLELİ KABLO UCU



0,5 ~ 1,5 mm<sup>2</sup>, Kablo Kesiti



1,5 ~ 2,5 mm<sup>2</sup>, Kablo Kesiti



4,0 ~ 6,0 mm<sup>2</sup>, Kablo Kesiti

KOD	METRİK ÖLÇ. (d2)	B	L	F	E	D	d1	AD. / ʘ	K. AD.
ONKA - 8290-H1-4V	4.3	8.0	21.0	7.0	10.0	4.1	1.7	0.112	100
ONKA - 8291-H1-5V	5.3	8.0	21.0	7.0	10.0	4.1	1.7	0.112	100
ONKA - 8292-H1-6V	6.5	11.6	26.8	11.1	10.0	4.1	1.7	0.168	100

ONKA - 8293-H2-4V	4.3	8.5	22.0	7.8	10.0	4.5	2.3	0.154	100
ONKA - 8294-H2-5V	5.3	9.5	22.0	7.3	10.0	4.5	2.3	0.154	100
ONKA - 8295-H2-6V	6.5	12.0	27.0	11.0	10.0	4.5	2.3	0.189	100

ONKA - 8296-H5-4V	4.3	9.5	25.5	8.3	12.5	6.5	3.4	0.245	50
ONKA - 8297-H5-5V	5.3	9.5	25.0	8.3	12.5	6.5	3.4	0.245	50
ONKA - 8298-H5-6V	6.5	12.0	29.0	10.5	12.5	6.5	3.4	0.245	50

Pirinç Malzemededen Kalay Kaplı,  
PVC İzoleli,  
75 °C Çalışma Sıcaklığı,  
300 Volt Enerjiye Dayanabilme.

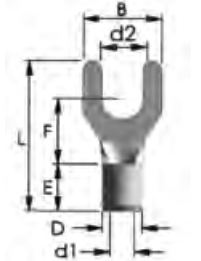

## İZOLESİZ (Kaynaklı) ÇATAL KABLO UCU



KOD	METRİK ÖLÇ. (d2)	B	L	F	E	D	d1	AD. / ʘ	K. AD.
ONKA - 8301-S1-3 NB	3.2	5.8	16.0	6.3	5.0	3.4	1.7	0.130	1.000
ONKA - 8302-S1-4 MNB	4.3	7.2	16.0	6.3	5.0	3.4	1.7	0.130	1.000
ONKA - 8303-S1-5 SNB	5.3	8.0	16.0	7.0	5.0	3.4	1.7	0.140	1.000
ONKA - 8304-S1-6 SNB	6.5	9.5	16.0	7.0	5.0	3.4	1.7	0.140	1.000
ONKA - 8305-S1-8 NB	8.4	12.0	22.2	11.0	5.0	3.4	1.7	0.168	1.000
ONKA - 8306-S2-3 NB	3.2	5.8	16.0	6.3	5.0	4.1	2.3	0.140	1.000
ONKA - 8307-S2-4 MNB	4.3	7.2	16.2	6.5	5.0	4.1	2.3	0.140	1.000
ONKA - 8308-S2-5 SNB	5.3	8.5	17.0	7.3	5.0	4.1	2.3	0.147	1.000
ONKA - 8309-S2-6 SNB	6.5	9.5	17.0	7.3	5.0	4.1	2.3	0.147	1.000
ONKA - 8310-S2-8 NB	8.4	12.0	22.0	11.0	5.0	4.1	2.3	0.175	1.000
ONKA - 8311-S5-4 SNB	4.3	8.5	18.7	7.5	6.0	5.6	3.4	0.189	500
ONKA - 8312-S5-5 NB	5.3	9.5	18.7	7.5	6.0	5.6	3.4	0.189	500
ONKA - 8313-S5-6 SNB	6.5	9.5	18.7	7.5	6.0	5.6	3.4	0.189	500
ONKA - 8314-S5-8 NB	8.4	13.5	23.5	10.5	6.0	5.6	3.4	0.280	500
ONKA - 8315-S8-4 NB	4.3	8.2	20.5	8.1	8.5	7.2	4.5	0.385	500
ONKA - 8316-S8-5 NB	5.3	9.0	20.5	8.1	8.5	7.2	4.5	0.405	500
ONKA - 8317-S8-6 NB	6.5	10.8	22.5	8.6	8.5	7.2	4.5	0.420	500

## YASSI GEÇME TİP DİŞİ - ERKEK TERMINALLER

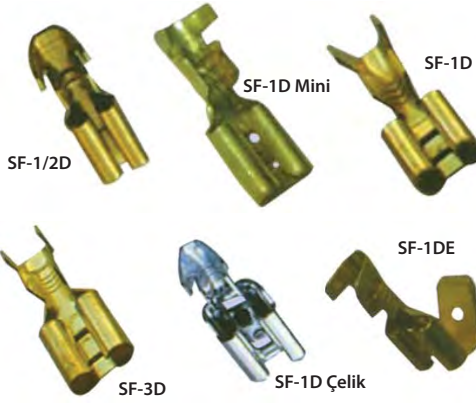

KOD	AÇIKLAMA	AD. / ʘ	K. AD.
ONKA -8650	SF-1D	6.3 Dişi Terminal	0.068 300
ONKA -8651	SF-2D	6.3 Dişi Terminal Tırnaklı	0.068 300
ONKA -8652	SF-3D	9.5 Dişi Terminal	0.150 100
ONKA -8653	SF-1/2 D	2.8 Dişi Terminal	0.027 1000
ONKA -8654	SF-1D	4.8 Mini Dişi Terminal	0.057 500
ONKA -8354	SF-1D	6.3 RÇN-DÇN Çelik Terminal	0.080 300
ONKA -8355	SF-1D	6.3 Eğri Dişi Terminal	0.123 250
ONKA -8356	SF-1D	Mini Eğri Dişi Terminal	0.062 400
ONKA -8656	SF-2.5 D	7.7 Eğri Dişi Terminal	0.083 200
ONKA -8657	SF-3D	9.5 Eğri Terminal	0.350 100
ONKA -8658	SF-1D E	6.5 Dişi-Erkek Terminal	0.145 100

## YASSI GEÇME TİP DİŞİ - ERKEK TERMINALLER



KOD	AÇIKLAMA	AD. / ʘ	K. AD.
ONKA -8659	SF-1E ÇK	6.3 Erkek Terminal	0.108 300
ONKA -8660	SF-1EU1	6.3 Erkek Terminal	0.080 300
ONKA -8661	SKN-1/2	4.8 Erkek Terminal	0.046 500

## TOPRAKLAMA TİPİ TERMINALLER



KOD	AÇIKLAMA	AD. / ʘ	K. AD.
ONKA -8663	SK-2.5	04 Topraklama Tipi Terminal	0.122 1000
ONKA -8664	SK-4	05 Topraklama Tipi Terminal	0.135 500
ONKA -8665	SK-6	06 Topraklama Tipi Terminal	0.160 250

## DELİKLİ TİP TOPRAKLAMA TERMINALLERİ



KOD	AÇIKLAMA	AD. / ʘ	K. AD.
ONKA -8357	SW-4	03/04 Topraklama Terminal	0.049 1000
ONKA -8666	SKN-1	03/0 Topraklama Terminal	0.045 500
ONKA -8667	SKN-2.5	04/05/06 Topraklama Terminal	0.090 400
ONKA -8668	SKN-4	04/05/06 Topraklama Terminal	0.113 250
ONKA -8669	SKN-6	06/08 Topraklama Terminal	0.192 150
ONKA -8670	SKN-10	08/10/12/13 Topraklama Terminal	0.200 100

## ÇATAL TİP TOPRAKLAMA TERMINALLERİ



KOD	AÇIKLAMA	AD. / ʘ	K. AD.
ONKA -8671	SKN-1C	Çatal Tip Top. Terminali	0.072 750
ONKA -8672	SKN-2.5	Çatal Tip Top. Terminali	0.085 500
ONKA -8673	SKN-4C	Çatal Tip Top. Terminali	0.132 250
ONKA -8674	SKN-6C	Çatal Tip Top. Terminali	0.207 150

## DİŞİ GEÇMELİ TİP TERMINALLER



KOD	AÇIKLAMA	AD. / ʘ	K. AD.
ONKA -8675	SF-4D	Dişi Geçmeli Tip Terminal	0.081 300
ONKA -8676	SF-4E	Erkek Geçmeli Tip Terminal	0.079 300
ONKA -8677	SF-4D O	Dişi Geçmeli Tip Terminal	0.081 300
ONKA -8678	SF-4E O	Erkek Geçmeli Tip Terminal	0.079 300

## YASSI GEÇME TİP ERKEK TERMINALLER



KOD	AÇIKLAMA	AD. / ʘ	K. AD.
ONKA -8358	SFK-1	1-04 (6.3) Top Erkek Terminal	0.086 1000
ONKA -8359	SFK-4	4-03 (4.8) Top Erkek Terminal	0.090 1000
ONKA -8363	SFK-25	Kart Tip Erkek Terminal 6.3	0.112 1000
ONKA -8364	SFK-35	Kart Tip Erkek Terminal 6.3	0.082 1000
ONKA -8365	SFK-39	Kart Tip Erkek Terminal 6.3	0.092 1000
ONKA -8366	SFK-43	Kart Tip Erkek Terminal 6.3	0.102 1000
ONKA -8367	SFK-25	Mini Kart Tip Erkek Terminal 4.8	0.110 1000

## RPK TİP TERMINALLER



KOD	AÇIKLAMA	AD. / ʘ	K. AD.
ONKA -8368	SF-22	Erkek Terminal RPK	0.136 4000
ONKA -8369	SF-22	Dişi Terminal RPK	0.126 4000

## YASSI GEÇME TİP DİŞİ TERMINALLER



KOD	AÇIKLAMA	AD. / ʘ	K. AD.
ONKA -8383	SF-1D	Mini DÇN Terminal	0.079 500
ONKA -8384	SF-1D	1D B Dişi Terminal	0.076 300
ONKA -8385	SF-1D	1D K Dişi Terminal	0.066 300
ONKA -8386	SF-W	W Buji Kablo Ucu	0.095 100



## TERMİNAL KILIFLARI



KOD	AÇIKLAMA	AD. / ʘ	K. AD.
ONKA - 8679	SF-1D	Terminal Kılıfı (PE)	0.038 300
ONKA - 8680	SF-2D	Mini Terminal Kılıfı (PE)	0.031 250
ONKA - 8681	SF-3D	Terminal Kılıfı (PE)	0.042 100
ONKA - 8387	SF-1D	Terminal Kılıfı (PVC)	0.045 300
ONKA - 8388	SF-4D	Terminal Kılıfı (PE)	0.031 100
ONKA - 8389	SF-1E	Terminal Kılıfı (PE)	0.045 500

## KONNEKTÖRLER

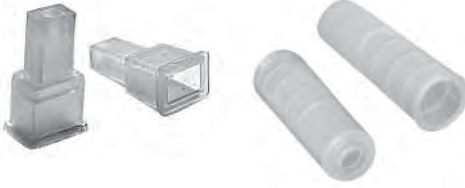

KOD	AÇIKLAMA	AD. / ʘ	K. AD.
ONKA - 8393	SF-1D	Eğri Konnektör	0.035 250
ONKA - 8394	R-Tipi	6.3 Konnektör (SF-2D)	0.038 300
ONKA - 8397	R-Tipi	4.8 Konnektör (SF-1D mini)	0.035 500
ONKA - 8398	R-Tipi	2.8 Konnektör (SF-1/2D)	0.028 1000

## ERKEK VE DIŞI KONNEKTÖRLER

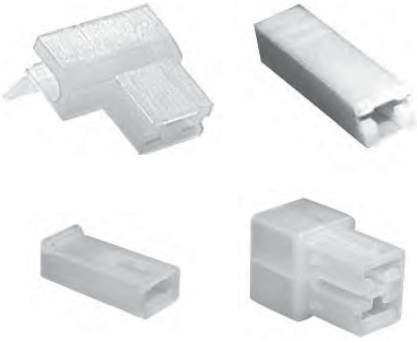

KOD	AÇIKLAMA	AD. / ʘ	K. AD.
ONKA - 8399	101	1'li Erkek Konnektör	0.082 100
ONKA - 8400	102	1'li Dişi Konnektör	0.091 100
ONKA - 8401	201	2'li Erkek Konnektör	0.140 100
ONKA - 8402	202	2'li Dişi Konnektör	0.151 100
ONKA - 8403	301	3'lü Erkek Konnektör	0.280 100
ONKA - 8404	302	3'lü Dişi Konnektör	0.297 100
ONKA - 8683	401	4'lü Erkek Konnektör	0.440 100
ONKA - 8684	402	4'lü Dişi Konnektör	0.460 100
ONKA - 8685	601	6'lü Erkek Konnektör	0.540 100
ONKA - 8686	602	6'lü Dişi Konnektör	0.560 100
ONKA - 8687	801	8'lü Erkek Konnektör	0.600 100
ONKA - 8688	802	8'lü Dişi Konnektör	0.620 100
ONKA - 8405		12'li Fişli Klemens	3.950 1

## ERKEK VE DIŞI KONNEKTÖRLER



KOD	AÇIKLAMA	AD. / ʘ	K. AD.
ONKA - 8406	GF-1D	6.3 GM. KAP. Terminal	0.112 300
ONKA - 8407	GF-2D	6.3 GM. KAP. Terminal	0.112 300
ONKA - 8408	GF-1D	4.8 Mini KAP. Terminal	0.093 500
ONKA - 8409	GF-1D	6.3 Eğri KAP. Terminal	0.195 250
ONKA - 8413	GF-1EU1	Eğri KAP. Terminal	0.125 300
ONKA - 8414	GF-1/2 D	1/2 GM. KAP. Terminal	0.047 1000

## KAPLAMALI TERMİNALLER



KOD	AÇIKLAMA	AD. / ʘ	K. AD.
ONKA - 8415	GK-2.5	04 GM. KAP. Terminal	0.190 1000
ONKA - 8416	GK-4	05 GM. KAP. Terminal	0.418 500
ONKA - 8417	GK-6	06 GM. KAP. Terminal	0.415 250

## BAKIR TİPİ KABLO UÇLARI



BA - 35

BA - 25

BA - 16

BA - 10

KOD	AÇIKLAMA	AD. / ʘ	K. AD.
ONKA - 8418	BA-10	Bakır Top. Kablo Ucu	0.436 100
ONKA - 8419	BA-16	Bakır Top. Kablo Ucu	0.592 100
ONKA - 8436	BA-25	Bakır Top. Kablo Ucu	1.090 100
ONKA - 8437	BA-35	Bakır Top. Kablo Ucu	1.695 50
ONKA - 8438	BA-50	Bakır Top. Kablo Ucu	3.125 25
ONKA - 8439	BA-70	Bakır Top. Kablo Ucu	3.630 25

## BAKIR TİPİ KABLO UÇLARI



BK - 6 - 6

BK - 8 - 6

BK - 10 - 10

BK - 6 - 35

KOD	AÇIKLAMA	AD. / ʘ	K. AD.
ONKA - 8440	BK-6-6	Bakır Top. Kablo Ucu	0.415 1000
ONKA - 8441	BK-8-6	Bakır Top. Kablo Ucu	0.515 1000
ONKA - 8442	BK-8-10	Bakır Top. Kablo Ucu	0.780 1000
ONKA - 8443	BK-10-10	Bakır Top. Kablo Ucu	0.780 1000
ONKA - 8444	BK-6-35	Bakır Top. Kablo Ucu	1.230 1000
ONKA - 8446	BK-8-35	Bakır Top. Kablo Ucu	1.254 500

## BORU TİPİ TERMİNALLER

KOD	AÇIKLAMA	AD. / ʘ	K. AD.
ONKA - 8447	SF - 18 D	Dişi Boru Tipi Terminal	0.080 1000
ONKA - 8448	SFK - 8 DP	Terminal	0.122 1000

## KABLO BAĞLARI

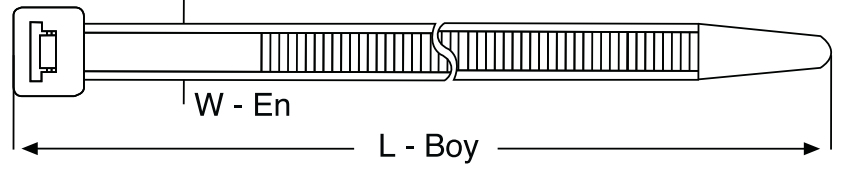
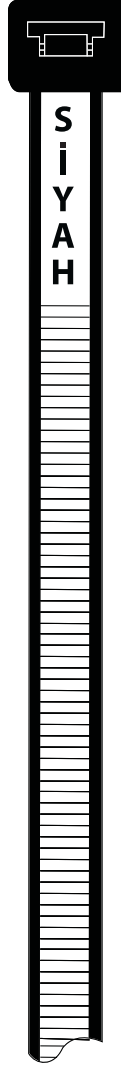
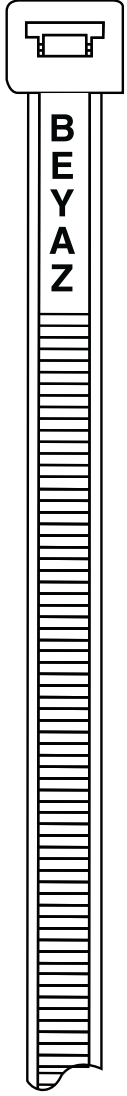

KOD	L	W	MAK. BAĞ. ÇAPI	TAŞI. AĞIR. (kg)	AD. / ʘ	POŞET ADEDİ	KOLİ ADEDİ
ONKA - 8480	100	2.5	22	8.1	0.009	100 / 1000	70.000
ONKA - 8432	140	2.5	40	8.1	0.017	100 / 1000	45.000 / 50.000
ONKA - 8481	160	2.5	40	8.1	0.024	100 / 1000	45.000 / 50.000
ONKA - 8482	200	2.5	53	8.1	0.027	100 / 1000	40.000 / 45.000
ONKA - 8483	150	3.6	35	18.2	0.027	100 / 1000	33.000
ONKA - 8484	200	3.6	53	18.2	0.038	100 / 1000	25.000
ONKA - 8485	250	3.6	65	18.2	0.052	100 / 1000	20.000
ONKA - 8486	300	3.6	76	18.2	0.065	100 / 1000	20.000
ONKA - 8487	370	3.6	102	18.2	0.082	100 / 1000	15.000
ONKA - 8488	160	4.8	38	22.2	0.040	100	20.000
ONKA - 8489	200	4.8	50	22.2	0.050	100	16.000
ONKA - 8490	250	4.8	60	22.2	0.074	100	13.000
ONKA - 8491	300	4.8	76	22.2	0.087	100	13.000
ONKA - 8492	370	4.8	102	22.2	0.100	100	10.000
ONKA - 8493	430	4.8	110	22.2	0.140	100	9.000
ONKA - 8494	530	4.8	140	22.2	0.235	100	8.000
ONKA - 8495	300	7.6	76	54.5	0.158	100	6.500
ONKA - 8496	370	7.6	102	54.5	0.199	100	5.000
ONKA - 8497	450	7.6	127	54.5	0.320	100	3.500
ONKA - 8498	530	7.6	140	54.5	0.465	100	3.000
ONKA - 8499	710	7.6	190	54.5	0.630	100	2.000
ONKA - 8500	430	9.0	125	79.4	0.340	100	3.000
ONKA - 8501	530	9.0	140	79.4	0.520	100	3.000
ONKA - 8502	710	9.0	190	79.4	0.690	100	2.000
ONKA - 8503	810	9.0	240	79.4	0.735	100	1.000
ONKA - 8504	940	9.0	280	79.4	0.900	100	1.000
ONKA - 8505	1220	9.0	365	79.4	1.500	100	1.000
ONKA - 8523	1530	9.0	365	79.4	2.100	100	1.000



B

S

GW ürünleri DUPONT marka, nylon 6/6 hammaddeden imal edilmiş olup, -40 - 85 °C ortam sıcaklığında çalışır. UL 94 / V2 normunda, kendini söndürme özelliğine sahiptir. Yüksek kaliteli GW kablo bağları (benzin, mazot, hayvansal yağ, boya, vernik) gibi maddelere karşı üstün direnç göstermektedir. Ürünler beyaz / siyah ve yandaki renkler olarak STOK mevcuttur. Beyaz / siyah renk dışındaki kablo bağlarının fiyatları farklıdır. Diğer renk istekleriniz için firmamızla irtibata geçiniz. Ürünlerimizin dış ortam kullanımı için UV Modelleri mevcuttur.

## KABLO BAĞLARI (Renkli)

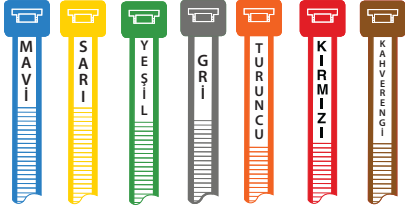

KOD	L	W	MAK. BAĞ. ÇAPI	TAŞI. AĞIR. (kg)	AD. / ʘ	POŞET ADEDİ	KOLİ ADEDİ
ONKA - 8178	100	2.5	22	8.1	0.013	100 / 1000	70.000
ONKA - 8179	160	2.5	40	8.1	0.033	100 / 1000	45.000 / 50.000
ONKA - 8180	200	2.5	53	8.1	0.038	100 / 1000	40.000 / 45.000
ONKA - 8181	150	3.6	35	18.2	0.038	100 / 1000	35.000
ONKA - 8182	200	3.6	53	18.2	0.053	100 / 1000	25.000
ONKA - 8183	250	3.6	65	18.2	0.076	100 / 1000	20.000
ONKA - 8184	300	3.6	76	18.2	0.085	100 / 1000	20.000
ONKA - 8185	300	4.8	76	22.2	0.128	100	13.000
ONKA - 8205	370	4.8	102	22.2	0.161	100	10.000
ONKA - 8209	370	7.6	102	54.5	0.280	100	5.000
ONKA - 8218	450	7.6	127	54.5	0.460	100	3.000
ONKA - 8219	530	7.6	140	54.5	0.660	100	3.000

GW ürünleri DUPONT marka, nylon 6/6 hammaddeden imal edilmiş olup, - 40 - 85 °C ortam sıcaklığında çalışır. UL 94 / V2 normunda, kendini söndürme özelliğine sahiptir. Yüksek kaliteli GW kablo bağları (benzin, mazot, hayvansal yağ, boya, vernik) gibi maddelere karşı üstün direnç göstermektedir. Ürünler beyaz / siyah ve yandaki renkler olarak STOK mevcuttur. Beyaz / siyah renk dışındaki kablo bağlarının fiyatları farklıdır. Diğer renk istekleriniz için firmamızla irtibata geçiniz. Ürünlerimizin dış ortam kullanımı için UV modelleri mevcuttur.

## ULTRA VIOLE KABLO BAĞLARI

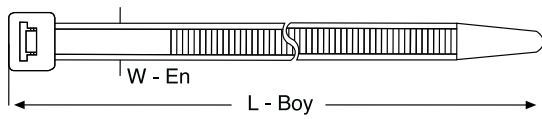

KOD	L	W	MAK. BAĞ. ÇAPI	TAŞI. AĞIR. (kg)	AD. / ʘ	POŞET ADEDİ	KOLİ ADEDİ
ONKA - 8570	100	2.5	22	8.1	0.019	100 / 1000	70.000
ONKA - 8571	200	2.5	53	8.1	0.054	100 / 1000	45.000 / 50.000
ONKA - 8326	150	3.6	35	18.2	0.054	100 / 1000	33.000
ONKA - 8327	200	3.6	53	18.2	0.080	100 / 1000	25.000
ONKA - 8328	250	3.6	65	18.2	0.100	100 / 1000	20.000
ONKA - 8329	300	3.6	76	18.2	0.110	100	20.000
ONKA - 8572	300	4.8	76	22.2	0.168	100	13.000
ONKA - 8573	370	4.8	102	22.2	0.200	100	10.000
ONKA - 8336	370	7.6	102	54.5	0.350	100	5.000
ONKA - 8337	450	7.6	127	54.5	0.580	100	3.500
ONKA - 8338	530	7.6	140	54.5	0.820	100	3.000

## CIRT CIRTLI KABLO BAĞLARI

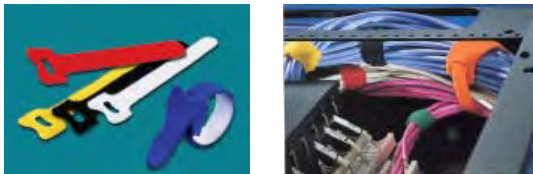

KOD	L	W	MAK. BAĞ. ÇAPI	AD. / ʘ	POŞET ADEDİ	KOLİ ADEDİ
ONKA - 8470	125	12	30	1.140	20	9.000
ONKA - 8471	150	12	36	1.330	20	9.000
ONKA - 8472	250	16	50	1.710	20	5.000
ONKA - 8563	125	12	30	1.140	20	9.000
ONKA - 8564	150	12	36	1.330	20	9.000
ONKA - 8565	210	16	50	1.710	20	5.000

## PASLANMAZ SINIFI 304-316 ÇELİK KABLO BAĞLARI

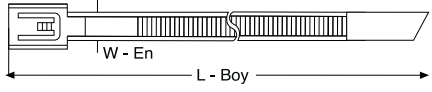
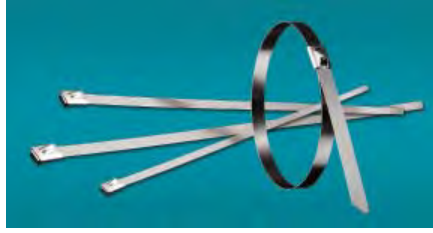

KOD	L	W	MAK. BAĞ. ÇAPI	TAŞI. AĞIR. (kg)	AD. / TL 304 PASLANMAZ	AD. / 316 PASLANMAZ	POŞET ADEDİ	KOLİ ADEDİ
ONKA - 8600	127	4.6	25.0	46	0.63	0.91	100	8000
ONKA - 8601	152	4.6	37.0	46	0.66	0.99	100	8000
ONKA - 8602	201	4.6	50.0	46	0.74	1.10	100	6000
ONKA - 8603	266	4.6	69.0	46	0.79	1.24	100	6000
ONKA - 8604	300	4.6	76.0	46	0.91	1.32	100	4000
ONKA - 8605	362	4.6	102	46	0.99	1.48	100	4000
ONKA - 8606	521	4.6	152	46	1.08	1.89	100	3000
ONKA - 8607	679	4.6	203	46	1.48	2.23	100	2000
ONKA - 8608	838	4.6	254	46	1.80	2.55	100	2000
ONKA - 8609	152	7.9	25.0	114	0.83	1.15	100	4000
ONKA - 8610	201	7.9	50.0	114	0.91	1.32	100	3000
ONKA - 8611	266	7.9	69.0	114	0.99	1.48	100	3000
ONKA - 8612	300	7.9	76.0	114	1.08	1.65	100	2000
ONKA - 8613	362	7.9	102	114	1.15	1.89	100	2000
ONKA - 8614	521	7.9	152	114	1.49	2.48	100	1500
ONKA - 8615	679	7.9	203	114	1.89	2.97	100	1000
ONKA - 8616	838	7.9	254	114	2.48	3.63	100	1000

## PASLANMAZ SINIFI 304 AKRİLİK KAPLI ÇELİK KABLO BAĞLARI



AISI 316 Paslanmaz Çelik

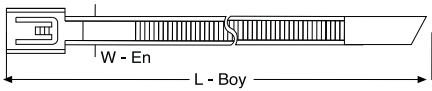

KOD	L	W	MAK. BAĞ. ÇAPI	TAŞI. AĞIR. (kg)	AD. / 304 PASLANMAZ	POŞET ADEDİ	KOLİ ADEDİ
ONKA - 8246	127	4.6	25.0	46	1.30	100	8000
ONKA - 8247	152	4.6	37.0	46	1.40	100	8000
ONKA - 8248	201	4.6	50.0	46	1.50	100	6000
ONKA - 8249	266	4.6	69.0	46	1.76	100	6000
ONKA - 8275	300	4.6	76.0	46	1.80	100	4000
ONKA - 8276	362	4.6	102	46	1.90	100	4000
ONKA - 8465	457	4.6	152	46	2.60	100	3000
ONKA - 8277	521	4.6	203	46	3.20	100	2000
ONKA - 8278	679	4.6	254	46	4.20	100	4000
ONKA - 8283	152	7.9	50.0	114	1.60	100	3000
ONKA - 8284	201	7.9	69.0	114	1.76	100	3000
ONKA - 8288	266	7.9	76.0	114	2.00	100	2000
ONKA - 8289	300	7.9	152	114	2.48	100	1500
ONKA - 8466	457	7.9	203	114	2.80	100	1000
ONKA - 8300	521	7.9	254	114	3.80	100	1000
ONKA - 8318	679	7.9	305	114	4.70	100	500

## PANELE KAFADAN SIKIŞAN KABLO BAĞI

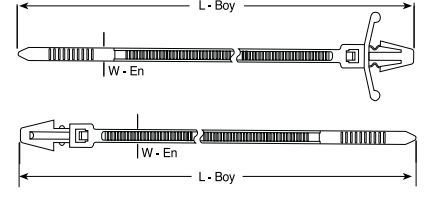

KOD	L	W	MAKSİMUM BAĞLAMA ÇAPI	TAŞIMA AĞIRLIĞI (kg)	AD. / ʘ	POŞET ADEDİ
ONKA - 8380	100	2.5	22	8.1	0.088	1000
ONKA - 8381	150	3.6	32	13.6	0.120	100
ONKA - 8382	200	4.8	46	22.2	0.145	100

## ETİKETLİ KABLO BAĞI

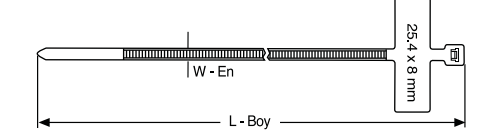
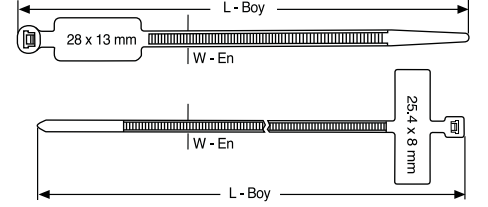
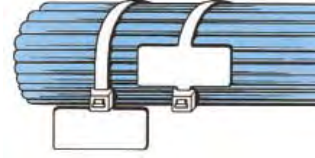
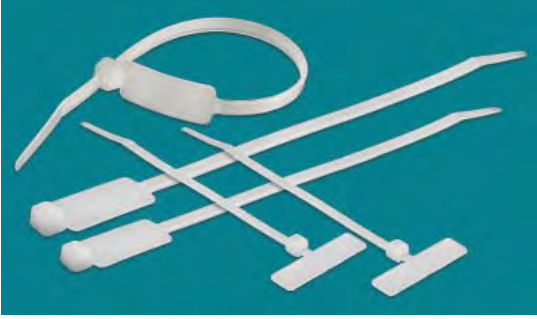

KOD	L	W	MAKSİMUM BAĞLAMA ÇAPI	TAŞIMA AĞIRLIĞI (kg)	AD. / ʘ	POŞET ADEDİ
ONKA - 8395	100	2.5	18	8.1	0.090	100
ONKA - 8396	195	4.8	45	22.2	0.120	100

## KAFADAN VİDA MONTAJLI KABLO BAĞI

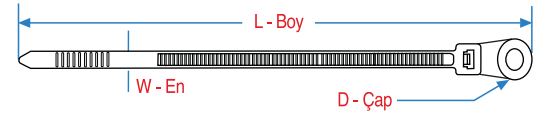

KOD	L	W	D	MAKSİMUM BAĞLAMA ÇAPI	TAŞIMA AĞIRLIĞI (kg)	AD. / ʘ	POŞET ADEDİ
ONKA - 8410	150	3.6	4.5	32	18.2	0.120	1000
ONKA - 8411	200	4.8	4.8	54	22.2	0.175	1000
ONKA - 8412	300	4.8	5.0	76	22.2	0.220	1000

## FLAT CABLE KABLO TUTUCUSU

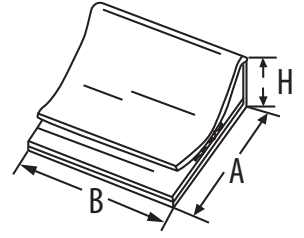
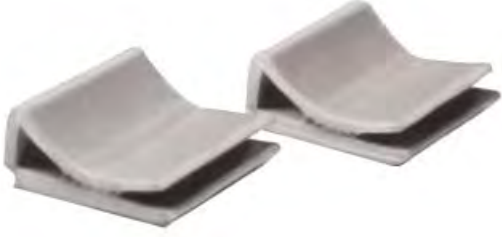

KOD	A	B	H	AD. / ʈ	KUTU ADEDİ
ONKA - 8433	15	26	6.5	0.340	100
ONKA - 8434	25	26	10.0	0.440	100

## BÜKÜLEBİLİR KLİPS

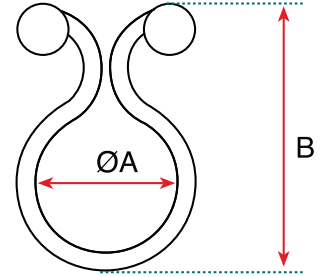
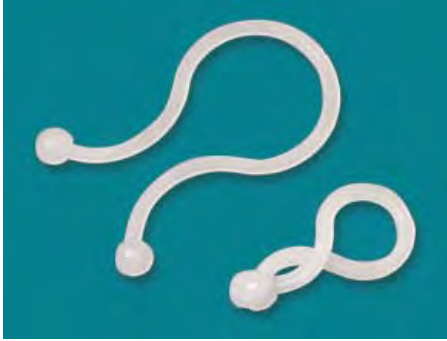

ÜRÜN CİNSİ	TH-D	TH-E	TH-F	TH-G	TH-H	TH-I	TH-J	TH-K	TH-L
KOD	ONKA-8370	ONKA-8371	ONKA-8372	ONKA-8373	ONKA-8374	ONKA-8375	ONKA-8376	ONKA-8377	ONKA-8378
ØA	11.2	5.2	8.3	11.5	15.0	18.0	19.5	22.5	5.2
B	28.4	21.0	25.2	30.9	35.1	40.0	42.5	45.5	22.0
BAĞLAMA ÇAPI	10.2	4.5	7.3	10.5	14.0	17.0	19.0	22.0	5.0
POŞET ADEDİ	1000	1000	1000	1000	1000	1000	1000	1000	1000
AD. / ʈ	0.059	0.042	0.056	0.059	0.089	0.117	0.180	0.226	0.059

## TABAN YAPIŞKANLI BÜKÜLEBİLİR KLİPS

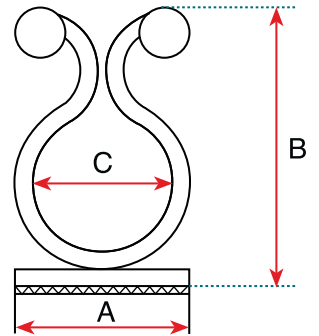

KOD	A	B	C	AD. / ʈ	POŞET ADEDİ
ONKA - 8435	20 x 20	32	16	0.350	100

## VİDALI KROŞELER

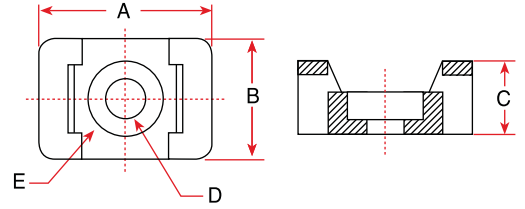

KOD	A	B	C	D	E	MAK. BAĞ. GENİŞLİĞİ	AD. / ʘ	KUTU ADEDİ	
ONKA - 8360	2	14.9	9.5	6.9	4.5	7.8	4.8	0.080	100
ONKA - 8361	3	22.2	15.9	9.7	6.4	12.6	7.6	0.145	100

## DÜŞÜK PROFİL TUTUCUSU

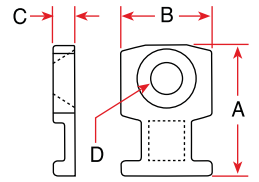

KOD	A	B	C	D	MAK. BAĞ. GENİŞLİĞİ	AD. / ʘ	KUTU ADEDİ
ONKA - 8445	19.1	12.7	3.4	4.5	4.8	0.035	100

## KABLO SIKIŞTIRICILARI

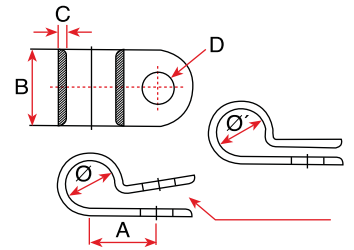

KOD	Ø	Ø'	A	B	C	D	AD. / ʘ	POŞET ADEDİ	
ONKA - 8450	1-8S	3.6	3.3	8.2	9.1	1.27	M5	0.095	100
ONKA - 8451	3-16S	5.3	4.8	9.6	9.1	1.27	M5	0.098	100
ONKA - 8452	1-4S	7.4	6.6	10.3	9.1	1.27	M5	0.085	100
ONKA - 8453	5-16S	8.9	7.8	10.6	9.1	1.27	M5	0.135	100
ONKA - 8454	3-8S	10.9	9.7	11.9	9.2	1.27	M5	0.135	100
ONKA - 8455	1-8	3.1	2.9	9.1	12.7	1.50	M5	0.120	100
ONKA - 8456	1-4	6.3	5.9	11.4	12.7	1.50	M5	0.135	100
ONKA - 8457	3-8	9.5	9.1	13.4	12.7	1.50	M5	0.150	100
ONKA - 8458	1-2	12.7	12.2	15.0	12.7	1.50	M5	0.180	100
ONKA - 8459	9-16	14.2	13.8	15.8	12.7	1.50	M5	0.210	100
ONKA - 8460	3-4	19.0	18.6	19.8	12.7	1.50	M5	0.240	100
ONKA - 8461	7-8	22.2	21.8	21.4	12.7	1.50	M5	0.300	100

## BETON KROŞE

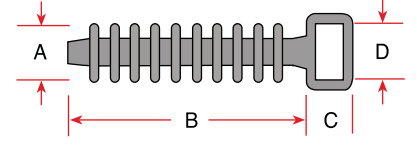

KOD	A	B	C	D	MAK. BAĞ. GENİŞLİĞİ	AD. / ʘ	KUTU ADEDİ
ONKA - 8362	9.5	36.0	6.0	9.5	9.5	0.120	100

## BASKILI DEVRE TAŞIYICILARI

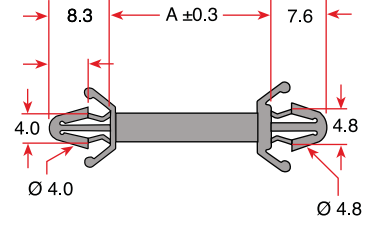
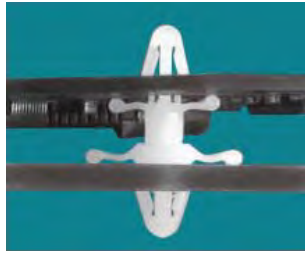

KOD	A	AD. / ʘ	KUTU ADEDİ
ONKA - 8420 CBS-6A	6.2	0.120	1000
ONKA - 8421 CBS-9A	9.2	0.135	1000
ONKA - 8422 CBS-13A	12.6	0.150	1000
ONKA - 8423 CBS-16A	15.8	0.180	1000
ONKA - 8424 CBS-19A	19.1	0.225	1000

## TERS KİLİTLEMELİ BASKILI DEVRE TAŞIYICILARI

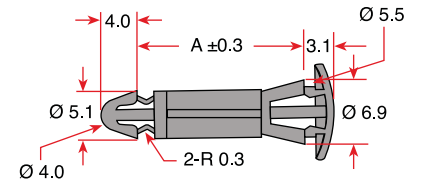

KOD	ÖLÇÜ (A)	AD. / ʘ	KUTU ADEDİ
ONKA - 8425 CBS-6R	5.8	0.105	1000
ONKA - 8426 CBS-7R	6.8	0.120	1000
ONKA - 8427 CBS-8R	8.0	0.125	1000
ONKA - 8428 CBS-10R	10.0	0.135	1000
ONKA - 8429 CBS-12R	12.0	0.150	1000
ONKA - 8430 CBS-14R	14.0 - 16.0	0.175	1000
ONKA - 8431 CBS-16R	19.1	0.215	1000





### ELEKTRONİK DEVRELİ KLEMENSLER

KOD	AÇIKLAMA	AD. / ʈ
ONKA-600-ERDM	Ters Akım Koruma Modülü	6.30
ONKA-601-ERDM	Bobin Ters Akım Koruma Modülü	6.30
ONKA-602-ERDM	Lamba Test Modülü Tekli	6.30
ONKA-603-ERDM	Lamba Test Modülü İkili	6.30
ONKA-604-ERDM	Gerilim Göstergesi 24 VDC.	6.66
ONKA-605-ERDM	Gerilim Göstergesi 220 VAC.	6.66
ONKA-606-ERDM	Gerilim Göstergesi Ters Akım Boşaltmalı 24 VDC.	7.67
ONKA-607-ERDM	Aşırı Gerilim Koruma 30 V.	6.66
ONKA-608-ERDM	Aşırı Gerilim Koruma 75 V.	6.66
ONKA-609-ERDM	Aşırı Gerilim Koruma 130 V.	6.66
ONKA-610-ERDM	Aşırı Gerilim Koruma 275 V.	6.66
ONKA-611-ERDM	Gerilim Göstergesi - Doğrultma 24 VAC.	8.62
ONKA-612-ERDM	Gerilim Göstergesi - Doğrultma 110 VAC.	8.62
ONKA-613-ERDM	Gerilim Göstergesi - Doğrultma 220 VAC.	8.62
ONKA-614-ERDM	Akım Göstergesi	8.62
ONKA-615-ERDM	Doğru Akım Gerilim Göstergesi 24VDC.	8.98
ONKA-616-ERDM	Boş Klemens	5.42

### OPTOKUPLER KARTI TEKLİ

ONKA-630-EROM	Optokupler Kartı 1 Kanal 5 VDC Giriş 24 VDC. Çıkış NPN	11.88
ONKA-631-EROM	Optokupler Kartı 1 Kanal 24 VDC Giriş 24 VDC. Çıkış NPN	11.85
ONKA-632-EROM	Optokupler Kartı 1 Kanal 24 VAC/DC Giriş 24 VDC. Çıkış NPN	12.85
ONKA-633-EROM	Optokupler Kartı 1 Kanal 110 VAC Giriş 24 VDC. Çıkış NPN	13.75
ONKA-634-EROM	Optokupler Kartı 1 Kanal 220 VAC Giriş 24 VDC. Çıkış NPN	13.75

### SOLIT STATE KARTI TEKLİ

ONKA-650-ERSSR	2 A. 220 VAC. Solid State Röle Tek Kanal 3 - 30 VDC. Giriş	25.00
ONKA-651-ERSSRD	3 A. 24 VDC. Solid State Röle Tek Kanal 5 - 30 VDC. Giriş	22.00

### NPN ve PNP ÇEVİRİCİ KARTLAR

ONKA-660-ERNPC	NPN Sinyali PNP'ye Çevirici Kart	23.00
ONKA-661-ERPNC	PNP Sinyali NPN'ye Çevirici Kart	23.00

### 2 A RÖLE KARTLARI TERS AKIM KORUMALI, LED'Lİ

ONKA-670-EKR12	12 V DC Röle 2 A. Tek Açık Kontak , Koruma Diyotlu ve Ledli	21.00
ONKA-671-EKR24	24 V DC Röle 2 A. Tek Açık Kontak , Koruma Diyotlu ve Ledli	21.00
ONKA-672-EKR24 AD	24 V AC/DC Röle 2 A. Tek Açık Kontak , Koruma Diyotlu ve Ledli	23.00
ONKA-673-EKR110	110 V AC Röle 2 A. Tek Açık Kontak , Koruma Diyotlu ve Ledli	25.00
ONKA-674-EKR220	220 V AC Röle 2 A. Tek Açık Kontak , Koruma Diyotlu ve Ledli	25.00



## DİYOT KARTLARI



KOD	AÇIKLAMA	AD. / ₺
ONKA-101-EDM6	Diyot Kartı 6 Kanallı	20.08
ONKA-102-EDM8	Diyot Kartı 8 Kanallı	23.05
ONKA-103-EDM12	Diyot Kartı 12 Kanallı	31.00
ONKA-104-EDM14A	Diyot Kartı 7 Kanallı Ortak Anot	25.17
ONKA-105-EDM14K	Diyot Kartı 7 Kanallı Ortak Katot	25.17
ONKA-106-EDM22A	Diyot Kartı 11 Kanallı Ortak Anot	36.77
ONKA-107-EDM22K	Diyot Kartı 11 Kanallı Ortak Katot	36.77

## OPTOKUPLER MODÜLÜ



KOD	AÇIKLAMA	AD. / ₺
ONKA-130-EOM-4	Optokupler Kartı 4 Kanallı 5 VDC Giriş, 24 VDC Çıkış, NPN	39.48
ONKA-131-EOM-4	Optokupler Kartı 4 Kanallı 12 VAC / DC Giriş, 24 VDC Çıkış, NPN	41.48
ONKA-132-EOM-4	Optokupler Kartı 4 Kanallı 24 VAC / DC Giriş, 24 VDC Çıkış, NPN	41.48
ONKA-133-EOM-4	Optokupler Kartı 4 Kanallı 110 VAC / DC Giriş, 24 VDC Çıkış, NPN	41.48
ONKA-134-EOM-4	Optokupler Kartı 4 Kanallı 220 VAC / DC Giriş, 24 VDC Çıkış, NPN	41.48

## AYARLANABİLİR REGÜLE



KOD	AÇIKLAMA	AD. / ₺
ONKA-210-ERK10	Regüle Kartı 1 A. Maksimum = 36 Volt Giriş	32.00
ONKA-211-ERK35	Regüle Kartı 3.5 A. Maksimum = 36 Volt Giriş	45.00
ONKA-212-ERK50	Regüle Kartı 5 A. Maksimum = 36 Volt Giriş	55.00

## ALARM İNDİKATÖRLERİ



KOD	AÇIKLAMA	AD. / ₺
ONKA-230-ESG72	8 Dijital Girişli 7 Segment Göstergeli Alarm İndikatörü 72 x 72	165.00
ONKA-231-ESG96	8 Dijital Girişli 7 Segment Göstergeli Alarm İndikatörü 96 x 96	180.00
ONKA-232-ELG96	8 Dijital Girişli LCD Göstergeli Alarm İndikatörü 96 x 96	210.00

## BÜYÜK DISPLAY SAYICI



KOD	AÇIKLAMA	AD. / ₺
ONKA-580-EBDS7S	7 Segment 5 Haneli Büyük Display Sayıcı Toplam Sayıcı Haneli Fabrikalarda makinelerin adet sayısını uzaktan görebilme imkanı sağlar. Adet sayısı üzerinden seçilebilir.	735.00

## RÖLE KARTLARI

## TEK KONTAK İKİLİ



KOD	AÇIKLAMA	AD. / ₺
ONKA-250-E12RMTL2 (+)	Tek Kontakt 16 A. Röle Modülü Lehimli "+ Ortak" 12 VDC.	36.82
ONKA-251-E12RMTS2 (+)	Tek Kontakt 16 A. Röle Modülü Sockets "+ Ortak" 12 VDC.	50.13
ONKA-252-E12RMTL2 (-)	Tek Kontakt 16 A. Röle Modülü Lehimli "- Ortak" 12 VDC.	36.82
ONKA-253-E12RMTS2 (-)	Tek Kontakt 16 A. Röle Modülü Sockets "- Ortak" 12 VDC.	50.13
ONKA-254-E24RMTL2 (+)	Tek Kontakt 16 A. Röle Modülü Lehimli "+ Ortak" 24 VDC.	36.71
ONKA-255-E24RMTS2 (+)	Tek Kontakt 16 A. Röle Modülü Sockets "+ Ortak" 24 VDC.	50.20
ONKA-256-E24RMTL2 (-)	Tek Kontakt 16 A. Röle Modülü Lehimli "- Ortak" 24 VDC.	36.71
ONKA-257-E24RMTS2 (-)	Tek Kontakt 16 A. Röle Modülü Sockets "- Ortak" 24 VDC.	50.20
ONKA-258-E24RMTLO2	Tek Kontakt 16 A. Röle Modülü Lehimli 24 VAC/DC.	37.67
ONKA-259-E24RMTSO2	Tek Kontakt 16 A. Röle Modülü Sockets 24 VAC/DC.	51.15
ONKA-260-E110RMTL2(+)	Tek Kontakt 16 A. Röle Modülü Lehimli "+ Ortak" 110 VDC.	59.81
ONKA-261-E110RMTS2(+)	Tek Kontakt 16 A. Röle Modülü Sockets "+ Ortak" 110 VDC.	74.29
ONKA-262-E110RMTL2(-)	Tek Kontakt 16 A. Röle Modülü Lehimli "- Ortak" 110 VDC.	59.81
ONKA-263-E110RMTS2(-)	Tek Kontakt 16 A. Röle Modülü Sockets "- Ortak" 110 VDC.	74.29
ONKA-264-E220RMTLO2	Tek Kontakt 16 A. Röle Modülü Lehimli 220 VAC.	59.81
ONKA-265-E220RMTSO2	Tek Kontakt 16 A. Röle Modülü Sockets 220 VAC.	74.33

**TEK KONTAK DÖRTLÜ**



ONKA-300-E12RMTL4 (+)	Tek Kontak 16 A. Röle Modülü Lehimli "+ Ortak" 12 VDC.	62.65
ONKA-301-E12RMTS4 (+)	Tek Kontak 16 A. Röle Modülü Socketli "+ Ortak" 12 VDC.	89.03
ONKA-302-E12RMTL4 (-)	Tek Kontak 16 A. Röle Modülü Lehimli "- Ortak" 12 VDC.	62.65
ONKA-303-E12RMTS4 (-)	Tek Kontak 16 A. Röle Modülü Socketli "- Ortak" 12 VDC.	89.03
ONKA-304-E24RMTL4 (+)	Tek Kontak 16 A. Röle Modülü Lehimli "+ Ortak" 24 VDC.	62.65
ONKA-305-E24RMTS4 (+)	Tek Kontak 16 A. Röle Modülü Socketli "+ Ortak" 24 VDC.	89.03
ONKA-306-E24RMTL4 (-)	Tek Kontak 16 A. Röle Modülü Lehimli "- Ortak" 24 VDC.	62.65
ONKA-307-E24RMTS4 (-)	Tek Kontak 16 A. Röle Modülü Socketli "- Ortak" 24 VDC.	89.03
ONKA-308-E24RMTLO4	Tek Kontak 16 A. Röle Modülü Lehimli 24 VAC/DC.	64.72
ONKA-309-E24RMTSO4	Tek Kontak 16 A. Röle Modülü Socketli 24 VAC/DC.	91.11
ONKA-310-E110RMTL4(+)	Tek Kontak 16 A. Röle Modülü Lehimli "+ Ortak" 110 VDC.	108.92
ONKA-311-E110RMTS4(+)	Tek Kontak 16 A. Röle Modülü Socketli "+ Ortak" 110 VDC.	137.35
ONKA-312-E110RMTL4(-)	Tek Kontak 16 A. Röle Modülü Lehimli "- Ortak" 110 VDC.	108.92
ONKA-313-E110RMTS4(-)	Tek Kontak 16 A. Röle Modülü Socketli "- Ortak" 110 VDC.	137.35
ONKA-314-E220RMTLO4	Tek Kontak 16 A. Röle Modülü Lehimli 220 VAC.	109.24
ONKA-315-E220RMTSO4	Tek Kontak 16 A. Röle Modülü Socketli 220 VAC.	137.68

**TEK KONTAK SEKİZLİ**



KOD	AÇIKLAMA	AD./₺
ONKA-350-E12RMTL8 (+)	Tek Kontak 16 A. Röle Modülü Lehimli "+ Ortak" 12 VDC.	112.32
ONKA-351-E12RMTS8 (+)	Tek Kontak 16 A. Röle Modülü Socketli "+ Ortak" 12 VDC.	164.23
ONKA-352-E12RMTL8 (-)	Tek Kontak 16 A. Röle Modülü Lehimli "- Ortak" 12 VDC.	112.32
ONKA-353-E12RMTS8 (-)	Tek Kontak 16 A. Röle Modülü Socketli "- Ortak" 12 VDC.	164.23
ONKA-354-E24RMTL8 (+)	Tek Kontak 16 A. Röle Modülü Lehimli "+ Ortak" 24 VDC.	112.32
ONKA-355-E24RMTS8 (+)	Tek Kontak 16 A. Röle Modülü Socketli "+ Ortak" 24 VDC.	164.23
ONKA-356-E24RMTL8 (-)	Tek Kontak 16 A. Röle Modülü Lehimli "- Ortak" 24 VDC.	112.32
ONKA-357-E24RMTS8 (-)	Tek Kontak 16 A. Röle Modülü Socketli "- Ortak" 24 VDC.	164.23
ONKA-358-E24RMTLO8	Tek Kontak 16 A. Röle Modülü Lehimli 24 VAC/DC.	116.62
ONKA-359-E24RMTSO8	Tek Kontak 16 A. Röle Modülü Socketli 24 VAC/DC.	168.80
ONKA-360-E110RMTL8(+)	Tek Kontak 16 A. Röle Modülü Lehimli "+ Ortak" 110 VDC.	204.96
ONKA-361-E110RMTS8(+)	Tek Kontak 16 A. Röle Modülü Socketli "+ Ortak" 110 VDC.	261.23
ONKA-362-E110RMTL8(-)	Tek Kontak 16 A. Röle Modülü Lehimli "- Ortak" 110 VDC.	204.96
ONKA-363-E110RMTS8(-)	Tek Kontak 16 A. Röle Modülü Socketli "- Ortak" 110 VDC.	261.23
ONKA-364-E220RMTLO8	Tek Kontak 16 A. Röle Modülü Lehimli 220 VAC.	205.10
ONKA-365-E220RMTSO8	Tek Kontak 16 A. Röle Modülü Socketli 220 VAC.	261.48

**TEK KONTAK ONALTILI**



ONKA-400-E24RMTL16 (+)	Tek Kontak 16 A. Röle Modülü Lehimli "+ Ortak" 24 VDC.	214.32
ONKA-401-E24RMTS16 (+)	Tek Kontak 16 A. Röle Modülü Socketli "+ Ortak" 24 VDC.	318.46
ONKA-402-E24RMTL16 (-)	Tek Kontak 16 A. Röle Modülü Lehimli "- Ortak" 24 VDC.	214.32
ONKA-403-E24RMTS16 (-)	Tek Kontak 16 A. Röle Modülü Socketli "- Ortak" 24 VDC.	318.46
ONKA-404-E220RMTLO16	Tek Kontak 16 A. Röle Modülü Lehimli 220 VAC.	400.15
ONKA-405-E220RMTSO16	Tek Kontak 16 A. Röle Modülü Socketli 220 VAC.	512.96

**ÇİFT KONTAK İKİLİ**



ONKA-420-E12RMCL2 (+)	Çift Kontak 8 A. Röle Modülü Lehimli "+ Ortak" 12 VDC.	45.08
ONKA-421-E12RMCS2 (+)	Çift Kontak 8 A. Röle Modülü Socketli "+ Ortak" 12 VDC.	54.58
ONKA-422-E12RMCL2 (-)	Çift Kontak 8 A. Röle Modülü Lehimli "- Ortak" 12 VDC.	45.08
ONKA-423-E12RMCS2 (-)	Çift Kontak 8 A. Röle Modülü Socketli "- Ortak" 12 VDC.	54.58
ONKA-424-E24RMCL2 (+)	Çift Kontak 8 A. Röle Modülü Lehimli "+ Ortak" 24 VDC.	45.08
ONKA-425-E24RMCS2 (+)	Çift Kontak 8 A. Röle Modülü Socketli "+ Ortak" 24 VDC.	54.58
ONKA-426-E24RMCL2 (-)	Çift Kontak 8 A. Röle Modülü Lehimli "- Ortak" 24 VDC.	45.08
ONKA-427-E24RMCS2 (-)	Çift Kontak 8 A. Röle Modülü Socketli "- Ortak" 24 VDC.	54.58
ONKA-428-E24RMCLO2	Çift Kontak 8 A. Röle Modülü Lehimli 24 VAC/DC.	69.99
ONKA-429-E24RMCISO2	Çift Kontak 8 A. Röle Modülü Socketli 24 VAC/DC.	79.56
ONKA-430-E110RMCL2(+)	Çift Kontak 8 A. Röle Modülü Lehimli "+ Ortak" 110 VDC.	87.82
ONKA-431-E110RMCS2(+)	Çift Kontak 8 A. Röle Modülü Socketli "+ Ortak" 110 VDC.	97.22
ONKA-432-E110RMCL2(-)	Çift Kontak 8 A. Röle Modülü Lehimli "- Ortak" 110 VDC.	87.82
ONKA-433-E110RMCS2(-)	Çift Kontak 8 A. Röle Modülü Socketli "- Ortak" 110 VDC.	97.22
ONKA-434-E220RMCLO2	Çift Kontak 8 A. Röle Modülü Lehimli 220 VAC.	83.39
ONKA-435-E220RMCISO2	Çift Kontak 8 A. Röle Modülü Socketli 220 VAC.	92.85

**ÇİFT KONTAK DÖRTLÜ**

ONKA-450-E12RMCL4 (+)	Çift Kontak 8 A. Röle Modülü Lehimli "+ Ortak" 12 VDC.	78.67
ONKA-451-E12RMCS4 (+)	Çift Kontak 8 A. Röle Modülü Socketsli "+ Ortak" 12 VDC.	97.76
ONKA-452-E12RMCL4 (-)	Çift Kontak 8 A. Röle Modülü Lehimli "- Ortak" 12 VDC.	78.67
ONKA-453-E12RMCS4 (-)	Çift Kontak 8 A. Röle Modülü Socketsli "- Ortak" 12 VDC.	97.76
ONKA-454-E24RMCL4 (+)	Çift Kontak 8 A. Röle Modülü Lehimli "+ Ortak" 24 VDC.	78.67
ONKA-455-E24RMCS4 (+)	Çift Kontak 8 A. Röle Modülü Socketsli "+ Ortak" 24 VDC.	97.76
ONKA-456-E24RMCL4 (-)	Çift Kontak 8 A. Röle Modülü Lehimli "- Ortak" 24 VDC.	78.67
ONKA-457-E24RMCS4 (-)	Çift Kontak 8 A. Röle Modülü Socketsli "- Ortak" 24 VDC.	97.76
ONKA-458-E24RMCLO4	Çift Kontak 8 A. Röle Modülü Lehimli 24 VAC/DC.	128.75
ONKA-459-E24RMC SO4	Çift Kontak 8 A. Röle Modülü Socketsli 24 VAC/DC.	147.91
ONKA-460-E110RMCL4(+)	Çift Kontak 8 A. Röle Modülü Lehimli "+ Ortak" 110 VDC.	163.79
ONKA-461-E110RMCS4(+)	Çift Kontak 8 A. Röle Modülü Socketsli "+ Ortak" 110 VDC.	182.96
ONKA-462-E110RMCL4(-)	Çift Kontak 8 A. Röle Modülü Lehimli "- Ortak" 110 VDC.	163.79
ONKA-463-E110RMCS4(-)	Çift Kontak 8 A. Röle Modülü Socketsli "- Ortak" 110 VDC.	182.96
ONKA-464-E220RMCLO4	Çift Kontak 8 A. Röle Modülü Lehimli 220 VAC.	163.79
ONKA-465-E220RMC SO4	Çift Kontak 8 A. Röle Modülü Socketsli 220 VAC.	182.96

**TEK KONTAK SEKİZLİ**

KOD	AÇIKLAMA	AD. / ₺
ONKA-500-E12RMCL8 (+)	Çift Kontak 8 A. Röle Modülü Lehimli "+ Ortak" 12 VDC.	111.65
ONKA-501-E12RMCS8 (+)	Çift Kontak 8 A. Röle Modülü Socketsli "+ Ortak" 12 VDC.	149.79
ONKA-502-E12RMCL8 (-)	Çift Kontak 8 A. Röle Modülü Lehimli "- Ortak" 12 VDC.	111.65
ONKA-503-E12RMCS8 (-)	Çift Kontak 8 A. Röle Modülü Socketsli "- Ortak" 12 VDC.	149.79
ONKA-504-E24RMCL8 (+)	Çift Kontak 8 A. Röle Modülü Lehimli "+ Ortak" 24 VDC.	111.65
ONKA-505-E24RMCS8 (+)	Çift Kontak 8 A. Röle Modülü Socketsli "+ Ortak" 24 VDC.	149.79
ONKA-506-E24RMCL8 (-)	Çift Kontak 8 A. Röle Modülü Lehimli "- Ortak" 24 VDC.	111.65
ONKA-507-E24RMCS8 (-)	Çift Kontak 8 A. Röle Modülü Socketsli "- Ortak" 24 VDC.	149.79
ONKA-508-E24RMCLO8	Çift Kontak 8 A. Röle Modülü Lehimli 24 VAC/DC.	248.69
ONKA-509-E24RMC SO8	Çift Kontak 8 A. Röle Modülü Socketsli 24 VAC/DC.	286.78
ONKA-510-E110RMCL8(+)	Çift Kontak 8 A. Röle Modülü Lehimli "+ Ortak" 110 VDC.	299.99
ONKA-511-E110RMCS8(+)	Çift Kontak 8 A. Röle Modülü Socketsli "+ Ortak" 110 VDC.	338.06
ONKA-512-E110RMCL8(-)	Çift Kontak 8 A. Röle Modülü Lehimli "- Ortak" 110 VDC.	299.99
ONKA-513-E110RMCS8(-)	Çift Kontak 8 A. Röle Modülü Socketsli "- Ortak" 110 VDC.	338.06
ONKA-514-E220RMCLO8	Çift Kontak 8 A. Röle Modülü Lehimli 220 VAC.	265.00
ONKA-515-E220RMC SO8	Çift Kontak 8 A. Röle Modülü Socketsli 220 VAC.	303.08

**EKONOMİK SERİ**

ONKA-530-ER24-4	Tek Kontak 3 A. Röle Modülü Lehimli 24 VDC. 4 Kanal	45.00
ONKA-531-ERO24-4	Tek Kontak 3 A. Röle Modülü Lehimli 24 VDC. "C Ortak" 4 Kanal	42.00
ONKA-532-ER24-8	Tek Kontak 3 A. Röle Modülü Lehimli 24 VDC. 8 Kanal	75.00
ONKA-533-ERO24-8	Tek Kontak 3 A. Röle Modülü Lehimli 24 VDC. "C Ortak" 8 Kanal	70.00

**PLC SERİSİ "C" ORTAK**

ONKA-540-E24PLC4	Tek Kontak 16 A. Röle Modülü Lehimli 24 VDC. 4 Kanal "C Ortak"	60.00
ONKA-541-E24PLCS4	Tek Kontak 16 A. Röle Modülü Socketsli 24 VDC. 4 Kanal "C Ortak"	85.00
ONKA-542-E24PLC8	Tek Kontak 16 A. Röle Modülü Lehimli 24 VDC. 8 Kanal "C Ortak"	99.00
ONKA-543-E24PLCS8	Tek Kontak 16 A. Röle Modülü Socketsli 24 VDC. 8 Kanal "C Ortak"	145.00

**TRANSİSTÖR KARTLARI**

KOD	AÇIKLAMA	AD. / ₺
ONKA-200-ETRK2	Transistör Kartı 2 Kanallı 24 VDC Giriş PNP/NPN 24 VDC. Çıkış PNP	40.00

**PROGRAMLAMA ve HABERLEŞME KABLOLARI**

KOD	AÇIKLAMA	AD. / ₺
ONKA-550-EPPI	PPI Kablo, S7-200 Programlama ve HMI Haberleşmesi İçin	188.00



### LAMBA TEST MODÜLLERİ

KOD	AÇIKLAMA	AD. / ₺
ONKA-120-ELT8	Lamba Test Kartı 8 Kanallı	25.45
ONKA-121-ELT16	Lamba Test Kartı 16 Kanallı	38.18



### SUP-D MODÜLLERİ

KOD	AÇIKLAMA	AD. / ₺
ONKA-150-ESUBM9D	SUB-D Dişi Soketten Klemense Çevirici 9 PİN	31.00
ONKA-151-ESUBM15D	SUB-D Dişi Soketten Klemense Çevirici 15 PİN	38.00
ONKA-152-ESUBM25D	SUB-D Dişi Soketten Klemense Çevirici 25 PİN	47.00
ONKA-153-ESUBM37D	SUB-D Dişi Soketten Klemense Çevirici 37 PİN	65.00
ONKA-154-ESUBM9E	SUB-D Erkek Soketten Klemense Çevirici 9 PİN	31.00
ONKA-155-ESUBM15E	SUB-D Erkek Soketten Klemense Çevirici 15 PİN	38.00
ONKA-156-ESUBM25E	SUB-D Erkek Soketten Klemense Çevirici 25 PİN	47.00
ONKA-157-ESUBM37E	SUB-D Erkek Soketten Klemense Çevirici 37 PİN	65.00

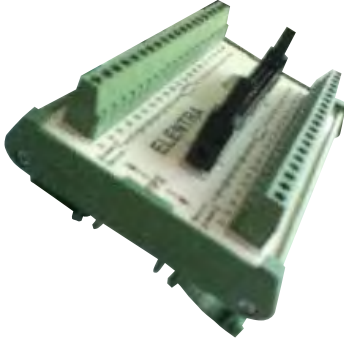

### YASSI KABLO MODÜLLERİ

KOD	AÇIKLAMA	AD. / ₺
ONKA-180-EYK10	Yassı Kablo Modülünden Klemense Çevirici 10 PİN Erkek	26.16
ONKA-181-EYK14	Yassı Kablo Modülünden Klemense Çevirici 14 PİN Erkek	30.64
ONKA-182-EYK16	Yassı Kablo Modülünden Klemense Çevirici 16 PİN Erkek	33.64
ONKA-183-EYK20	Yassı Kablo Modülünden Klemense Çevirici 20 PİN Erkek	40.04
ONKA-184-EYK26	Yassı Kablo Modülünden Klemense Çevirici 26 PİN Erkek	53.37
ONKA-185-EYK34	Yassı Kablo Modülünden Klemense Çevirici 34 PİN Erkek	63.52
ONKA-186-EYK40	Yassı Kablo Modülünden Klemense Çevirici 40 PİN Erkek	73.58
ONKA-187-EYK50	Yassı Kablo Modülünden Klemense Çevirici 50 PİN Erkek	86.55
ONKA-188-EYK60	Yassı Kablo Modülünden Klemense Çevirici 60 PİN Erkek	105.27
ONKA-189-EYK64	Yassı Kablo Modülünden Klemense Çevirici 64 PİN Erkek	113.07
ONKA-190-EYK400	Yassı Kablo Modülünden Klemense Çevirici 40 PİN Erkek FP2 İçin	73.58



### PC PANELLER

KOD	AÇIKLAMA	AD. / ₺
ONKA-551-ELPLC15S	15" Dokunmatik PC Panel Siyah	☺
ONKA-552-ELPLC15B	15" Dokunmatik PC Panel Beyaz	☺
ONKA-553-ELP15DS	15" Dokunmatik Panel Siyah	☺
ONKA-554-ELP15DB	15" Dokunmatik Panel Beyaz	☺
ONKA-560-ELPLC17S	17" Dokunmatik PC Panel Siyah	☺
ONKA-561-ELPLC17B	17" Dokunmatik PC Panel Beyaz	☺
ONKA-562-ELP17DS	17" Dokunmatik Panel Siyah	☺
ONKA-563-ELP17DB	17" Dokunmatik Panel Beyaz	☺
ONKA-564-ELP17S	17" Panel Siyah	☺
ONKA-565-ELP17B	17" Panel Beyaz	☺
ONKA-570-ELPLC19S	19" Dokunmatik PC Panel Siyah	☺
ONKA-571-ELPLC19B	19" Dokunmatik PC Panel Beyaz	☺
ONKA-572-ELP19DS	19" Dokunmatik Panel Siyah	☺
ONKA-573-ELP19DB	19" Dokunmatik Panel Beyaz	☺
ONKA-574-ELP19S	19" Panel Siyah	☺
ONKA-575-ELP19B	19" Panel Beyaz	☺

## TAKIM

SOKET BASKILI DEVRE KLEMENSİ (3.81 mm) 1,5 mm<sup>2</sup>

KOD	AÇIKLAMA	AD. / ʘ	K. AD.
MEGA 172 - SBDK	Soket Baskılı Devre Klemensi 2'li (3.81 mm) Takım	0.844	200
MEGA 173 - SBDK	Soket Baskılı Devre Klemensi 3'lü (3.81 mm) Takım	1.266	200
MEGA 174 - SBDK	Soket Baskılı Devre Klemensi 4'lü (3.81 mm) Takım	1.688	200
MEGA 175 - SBDK	Soket Baskılı Devre Klemensi 5'li (3.81 mm) Takım	2.110	200
MEGA 176 - SBDK	Soket Baskılı Devre Klemensi 6'li (3.81 mm) Takım	2.532	200
MEGA 177 - SBDK	Soket Baskılı Devre Klemensi 7'li (3.81 mm) Takım	2.954	200
MEGA 178 - SBDK	Soket Baskılı Devre Klemensi 8'li (3.81 mm) Takım	3.376	200
MEGA 182 - SBDK	Soket Baskılı Devre Klemensi 12'li (3.81 mm) Takım	5.064	200
MEGA 186 - SBDK	Soket Baskılı Devre Klemensi 16'li (3.81 mm) Takım	6.752	200

## DiŖi

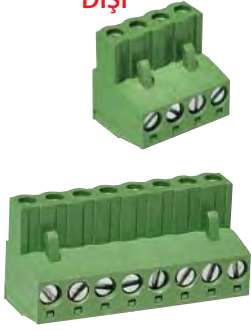
SOKET BASKILI DEVRE KLEMENSİ (3.81 mm) 1,5 mm<sup>2</sup>

KOD	AÇIKLAMA	AD. / ʘ	K. AD.
MEGA 172 - SBDK-D	Soket Baskılı Devre Klemensi 2'li (3.81 mm) DiŖi	0.6752	200
MEGA 173 - SBDK-D	Soket Baskılı Devre Klemensi 3'lü (3.81 mm) DiŖi	1.0128	200
MEGA 174 - SBDK-D	Soket Baskılı Devre Klemensi 4'lü (3.81 mm) DiŖi	1.3504	200
MEGA 175 - SBDK-D	Soket Baskılı Devre Klemensi 5'li (3.81 mm) DiŖi	1.6880	200
MEGA 176 - SBDK-D	Soket Baskılı Devre Klemensi 6'li (3.81 mm) DiŖi	2.0256	200
MEGA 177 - SBDK-D	Soket Baskılı Devre Klemensi 7'li (3.81 mm) DiŖi	2.3632	200
MEGA 178 - SBDK-D	Soket Baskılı Devre Klemensi 8'li (3.81 mm) DiŖi	2.7008	200
MEGA 182 - SBDK-D	Soket Baskılı Devre Klemensi 12'li (3.81 mm) DiŖi	4.0512	200
MEGA 186 - SBDK-D	Soket Baskılı Devre Klemensi 16'li (3.81 mm) DiŖi	5.4016	200

## ERKEK

SOKET BASKILI DEVRE KLEMENSİ (3.81 mm) 1,5 mm<sup>2</sup>

KOD	AÇIKLAMA	AD. / ʘ	K. AD.
MEGA 172 - SBDK-E	Soket Baskılı Devre Klemensi 2'li (3.81 mm) Erkek	0.2532	200
MEGA 173 - SBDK-E	Soket Baskılı Devre Klemensi 3'lü (3.81 mm) Erkek	0.3798	200
MEGA 174 - SBDK-E	Soket Baskılı Devre Klemensi 4'lü (3.81 mm) Erkek	0.5064	200
MEGA 175 - SBDK-E	Soket Baskılı Devre Klemensi 5'li (3.81 mm) Erkek	0.6330	200
MEGA 176 - SBDK-E	Soket Baskılı Devre Klemensi 6'li (3.81 mm) Erkek	0.7596	200
MEGA 177 - SBDK-E	Soket Baskılı Devre Klemensi 7'li (3.81 mm) Erkek	0.8862	200
MEGA 178 - SBDK-E	Soket Baskılı Devre Klemensi 8'li (3.81 mm) Erkek	1.0128	200
MEGA 182 - SBDK-E	Soket Baskılı Devre Klemensi 12'li (3.81 mm) Erkek	1.5192	200
MEGA 186 - SBDK-E	Soket Baskılı Devre Klemensi 16'li (3.81 mm) Erkek	2.0256	200

## TAKIM

SOKET BASKILI DEVRE KLEMENSİ (5.08 mm) 2,5 mm<sup>2</sup>

KOD	AÇIKLAMA	AD. / ʘ	K. AD.
MEGA 202 - SBDK	Soket Baskılı Devre Klemens 2'li (5.08 mm) Takım	0.770	200
MEGA 203 - SBDK	Soket Baskılı Devre Klemens 3'lü (5.08 mm) Takım	1.155	100
MEGA 204 - SBDK	Soket Baskılı Devre Klemens 4'lü (5.08 mm) Takım	1.540	100
MEGA 205 - SBDK	Soket Baskılı Devre Klemens 5'li (5.08 mm) Takım	1.925	100
MEGA 206 - SBDK	Soket Baskılı Devre Klemens 6'li (5.08 mm) Takım	2.310	100
MEGA 207 - SBDK	Soket Baskılı Devre Klemens 7'li (5.08 mm) Takım	2.695	100
MEGA 208 - SBDK	Soket Baskılı Devre Klemens 8'li (5.08 mm) Takım	3.080	100
MEGA 209 - SBDK	Soket Baskılı Devre Klemens 9'lu (5.08 mm) Takım	3.465	100
MEGA 210 - SBDK	Soket Baskılı Devre Klemens 10'lu (5.08 mm) Takım	3.850	50
MEGA 211 - SBDK	Soket Baskılı Devre Klemens 11'li (5.08 mm) Takım	4.235	50
MEGA 212 - SBDK	Soket Baskılı Devre Klemens 12'li (5.08 mm) Takım	4.620	50
MEGA 213 - SBDK	Soket Baskılı Devre Klemens 13'lü (5.08 mm) Takım	5.005	50
MEGA 214 - SBDK	Soket Baskılı Devre Klemens 14'lü (5.08 mm) Takım	5.390	50
MEGA 215 - SBDK	Soket Baskılı Devre Klemens 15'li (5.08 mm) Takım	5.775	50
MEGA 216 - SBDK	Soket Baskılı Devre Klemens 16'li (5.08 mm) Takım	6.160	50
MEGA 217 - SBDK	Soket Baskılı Devre Klemens 17'li (5.08 mm) Takım	6.545	50
MEGA 218 - SBDK	Soket Baskılı Devre Klemens 18'li (5.08 mm) Takım	6.930	50
MEGA 219 - SBDK	Soket Baskılı Devre Klemens 19'lu (5.08 mm) Takım	7.315	25
MEGA 220 - SBDK	Soket Baskılı Devre Klemens 20'li (5.08 mm) Takım	7.700	25
MEGA 221 - SBDK	Soket Baskılı Devre Klemens 21'li (5.08 mm) Takım	8.085	25
MEGA 222 - SBDK	Soket Baskılı Devre Klemens 22'li (5.08 mm) Takım	8.470	25
MEGA 223 - SBDK	Soket Baskılı Devre Klemens 23'lü (5.08 mm) Takım	8.855	25
MEGA 224 - SBDK	Soket Baskılı Devre Klemens 24'lü (5.08 mm) Takım	9.240	25
MEGA 225 - SBDK	Soket Baskılı Devre Klemens 25'li (5.08 mm) Takım	9.625	25

**DİŞİ**



**SOKET BASKILI DEVRE KLEMENSİ (5.08 mm) 2,5 mm<sup>2</sup>**

KOD	AÇIKLAMA	AD. / ʘ	K. AD.
MEGA 202 - SBDK-D	Soket Baskılı Devre Klemens 2'li (5.08 mm) Dişi	0.616	200
MEGA 203 - SBDK-D	Soket Baskılı Devre Klemens 3'lü (5.08 mm) Dişi	0.924	100
MEGA 204 - SBDK-D	Soket Baskılı Devre Klemens 4'lü (5.08 mm) Dişi	1.232	100
MEGA 205 - SBDK-D	Soket Baskılı Devre Klemens 5'li (5.08 mm) Dişi	1.540	100
MEGA 206 - SBDK-D	Soket Baskılı Devre Klemens 6'lı (5.08 mm) Dişi	1.848	100
MEGA 207 - SBDK-D	Soket Baskılı Devre Klemens 7'li (5.08 mm) Dişi	2.156	100
MEGA 208 - SBDK-D	Soket Baskılı Devre Klemens 8'li (5.08 mm) Dişi	2.464	100
MEGA 209 - SBDK-D	Soket Baskılı Devre Klemens 9'lu (5.08 mm) Dişi	2.772	100
MEGA 210 - SBDK-D	Soket Baskılı Devre Klemens 10'lu (5.08 mm) Dişi	3.080	50
MEGA 211 - SBDK-D	Soket Baskılı Devre Klemens 11'li (5.08 mm) Dişi	3.388	50
MEGA 212 - SBDK-D	Soket Baskılı Devre Klemens 12'li (5.08 mm) Dişi	3.696	50
MEGA 213 - SBDK-D	Soket Baskılı Devre Klemens 13'lü (5.08 mm) Dişi	4.004	50
MEGA 214 - SBDK-D	Soket Baskılı Devre Klemens 14'lü (5.08 mm) Dişi	4.312	50
MEGA 215 - SBDK-D	Soket Baskılı Devre Klemens 15'li (5.08 mm) Dişi	4.620	50
MEGA 216 - SBDK-D	Soket Baskılı Devre Klemens 16'lı (5.08 mm) Dişi	4.928	50
MEGA 217 - SBDK-D	Soket Baskılı Devre Klemens 17'li (5.08 mm) Dişi	5.236	50
MEGA 218 - SBDK-D	Soket Baskılı Devre Klemens 18'li (5.08 mm) Dişi	5.544	50
MEGA 219 - SBDK-D	Soket Baskılı Devre Klemens 19'lu (5.08 mm) Dişi	5.852	25
MEGA 220 - SBDK-D	Soket Baskılı Devre Klemens 20'li (5.08 mm) Dişi	6.160	25
MEGA 221 - SBDK-D	Soket Baskılı Devre Klemens 21'li (5.08 mm) Dişi	6.468	25
MEGA 222 - SBDK-D	Soket Baskılı Devre Klemens 22'li (5.08 mm) Dişi	6.776	25
MEGA 223 - SBDK-D	Soket Baskılı Devre Klemens 23'lü (5.08 mm) Dişi	7.084	25
MEGA 224 - SBDK-D	Soket Baskılı Devre Klemens 24'lü (5.08 mm) Dişi	7.392	25
MEGA 225 - SBDK-D	Soket Baskılı Devre Klemens 25'li (5.08 mm) Dişi	7.700	25

**ERKEK**

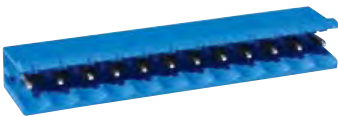

**SOKET BASKILI DEVRE KLEMENSİ (5.08 mm) 2,5 mm<sup>2</sup>**

KOD	AÇIKLAMA	AD. / ʘ	K. AD.
MEGA 202 - SBDK-E	Soket Baskılı Devre Klemens 2'li (5.08 mm) Erkek	0.2310	200
MEGA 203 - SBDK-E	Soket Baskılı Devre Klemens 3'lü (5.08 mm) Erkek	0.3465	100
MEGA 204 - SBDK-E	Soket Baskılı Devre Klemens 4'lü (5.08 mm) Erkek	0.4620	100
MEGA 205 - SBDK-E	Soket Baskılı Devre Klemens 5'li (5.08 mm) Erkek	0.5775	100
MEGA 206 - SBDK-E	Soket Baskılı Devre Klemens 6'lı (5.08 mm) Erkek	0.6930	100
MEGA 207 - SBDK-E	Soket Baskılı Devre Klemens 7'li (5.08 mm) Erkek	0.8085	100
MEGA 208 - SBDK-E	Soket Baskılı Devre Klemens 8'li (5.08 mm) Erkek	0.9240	100
MEGA 209 - SBDK-E	Soket Baskılı Devre Klemens 9'lu (5.08 mm) Erkek	1.0395	100
MEGA 210 - SBDK-E	Soket Baskılı Devre Klemens 10'lu (5.08 mm) Erkek	1.1550	50
MEGA 211 - SBDK-E	Soket Baskılı Devre Klemens 11'li (5.08 mm) Erkek	1.2705	50
MEGA 212 - SBDK-E	Soket Baskılı Devre Klemens 12'li (5.08 mm) Erkek	1.3860	50
MEGA 213 - SBDK-E	Soket Baskılı Devre Klemens 13'lü (5.08 mm) Erkek	1.5015	50
MEGA 214 - SBDK-E	Soket Baskılı Devre Klemens 14'lü (5.08 mm) Erkek	1.6170	50
MEGA 215 - SBDK-E	Soket Baskılı Devre Klemens 15'li (5.08 mm) Erkek	1.7325	50
MEGA 216 - SBDK-E	Soket Baskılı Devre Klemens 16'lı (5.08 mm) Erkek	1.8480	50
MEGA 217 - SBDK-E	Soket Baskılı Devre Klemens 17'li (5.08 mm) Erkek	1.9635	50
MEGA 218 - SBDK-E	Soket Baskılı Devre Klemens 18'li (5.08 mm) Erkek	2.0790	50
MEGA 219 - SBDK-E	Soket Baskılı Devre Klemens 19'lu (5.08 mm) Erkek	2.1945	25
MEGA 220 - SBDK-E	Soket Baskılı Devre Klemens 20'li (5.08 mm) Erkek	2.3100	25
MEGA 221 - SBDK-E	Soket Baskılı Devre Klemens 21'li (5.08 mm) Erkek	2.4255	25
MEGA 222 - SBDK-E	Soket Baskılı Devre Klemens 22'li (5.08 mm) Erkek	2.5410	25
MEGA 223 - SBDK-E	Soket Baskılı Devre Klemens 23'lü (5.08 mm) Erkek	2.6565	25
MEGA 224 - SBDK-E	Soket Baskılı Devre Klemens 24'lü (5.08 mm) Erkek	2.7720	25
MEGA 225 - SBDK-E	Soket Baskılı Devre Klemens 25'li (5.08 mm) Erkek	2.8875	25

## TAKIM

SOKET BASKILI DEVRE KLEMENSİ DİK (5.08 mm) 2.5 mm<sup>2</sup>

KOD	AÇIKLAMA	AD. / ʘ	K. AD.
MEGA 262 - SBDK	Soket Baskılı Devre Klemensi Dik (5.08 mm) Takım	0.960	200
MEGA 263 - SBDK	Soket Baskılı Devre Klemensi Dik (5.08 mm) Takım	1.440	100
MEGA 264 - SBDK	Soket Baskılı Devre Klemensi Dik (5.08 mm) Takım	1.920	100
MEGA 265 - SBDK	Soket Baskılı Devre Klemensi Dik (5.08 mm) Takım	2.400	100
MEGA 266 - SBDK	Soket Baskılı Devre Klemensi Dik (5.08 mm) Takım	ʘ	-
MEGA 267 - SBDK	Soket Baskılı Devre Klemensi Dik (5.08 mm) Takım	ʘ	-
MEGA 268 - SBDK	Soket Baskılı Devre Klemensi Dik (5.08 mm) Takım	ʘ	-
MEGA 269 - SBDK	Soket Baskılı Devre Klemensi Dik (5.08 mm) Takım	ʘ	-
MEGA 270 - SBDK	Soket Baskılı Devre Klemensi Dik (5.08 mm) Takım	ʘ	-
MEGA 271 - SBDK	Soket Baskılı Devre Klemensi Dik (5.08 mm) Takım	ʘ	-
MEGA 272 - SBDK	Soket Baskılı Devre Klemensi Dik (5.08 mm) Takım	ʘ	-

## DİŞİ

SOKET BASKILI DEVRE KLEMENSİ DİK (5.08 mm) 2.5 mm<sup>2</sup>

KOD	AÇIKLAMA	AD. / ʘ	K. AD.
MEGA 262 - SBDK-D	Soket Baskılı Devre Klemensi Dik (5.08 mm) Dişi	0.768	200
MEGA 263 - SBDK-D	Soket Baskılı Devre Klemensi Dik (5.08 mm) Dişi	1.152	100
MEGA 264 - SBDK-D	Soket Baskılı Devre Klemensi Dik (5.08 mm) Dişi	1.536	100
MEGA 265 - SBDK-D	Soket Baskılı Devre Klemensi Dik (5.08 mm) Dişi	1.920	100
MEGA 266 - SBDK-D	Soket Baskılı Devre Klemensi Dik (5.08 mm) Dişi	ʘ	-
MEGA 267 - SBDK-D	Soket Baskılı Devre Klemensi Dik (5.08 mm) Dişi	ʘ	-
MEGA 268 - SBDK-D	Soket Baskılı Devre Klemensi Dik (5.08 mm) Dişi	ʘ	-
MEGA 269 - SBDK-D	Soket Baskılı Devre Klemensi Dik (5.08 mm) Dişi	ʘ	-
MEGA 270 - SBDK-D	Soket Baskılı Devre Klemensi Dik (5.08 mm) Dişi	ʘ	-
MEGA 271 - SBDK-D	Soket Baskılı Devre Klemensi Dik (5.08 mm) Dişi	ʘ	-
MEGA 272 - SBDK-D	Soket Baskılı Devre Klemensi Dik (5.08 mm) Dişi	ʘ	-

## ERKEK

SOKET BASKILI DEVRE KLEMENSİ DİK (5.08 mm) 2.5 mm<sup>2</sup>

KOD	AÇIKLAMA	AD. / ʘ	K. AD.
MEGA 262 - SBDK-E	Soket Baskılı Devre Klemensi Dik (5.08 mm) Erkek	0.2310	200
MEGA 263 - SBDK-E	Soket Baskılı Devre Klemensi Dik (5.08 mm) Erkek	0.3465	100
MEGA 264 - SBDK-E	Soket Baskılı Devre Klemensi Dik (5.08 mm) Erkek	0.4620	100
MEGA 265 - SBDK-E	Soket Baskılı Devre Klemensi Dik (5.08 mm) Erkek	0.5775	100
MEGA 266 - SBDK-E	Soket Baskılı Devre Klemensi Dik (5.08 mm) Erkek	ʘ	-
MEGA 267 - SBDK-E	Soket Baskılı Devre Klemensi Dik (5.08 mm) Erkek	ʘ	-
MEGA 268 - SBDK-E	Soket Baskılı Devre Klemensi Dik (5.08 mm) Erkek	ʘ	-
MEGA 269 - SBDK-E	Soket Baskılı Devre Klemensi Dik (5.08 mm) Erkek	ʘ	-
MEGA 270 - SBDK-E	Soket Baskılı Devre Klemensi Dik (5.08 mm) Erkek	ʘ	-
MEGA 271 - SBDK-E	Soket Baskılı Devre Klemensi Dik (5.08 mm) Erkek	ʘ	-
MEGA 272 - SBDK-E	Soket Baskılı Devre Klemensi Dik (5.08 mm) Erkek	ʘ	-

## SOKET BASKILI DEVRE KLEMENSİ ERKEK (5.08 mm)



KOD	AÇIKLAMA	AD. / ʘ	K. AD.
MEGA 202-SBDK-KE	Soket Baskılı Devre Klemensi K. Erkek 2 x 2'li (5.08 mm)	0.690	100
MEGA 203-SBDK-KE	Soket Baskılı Devre Klemensi K. Erkek 2 x 3'lü (5.08 mm)	1.035	50

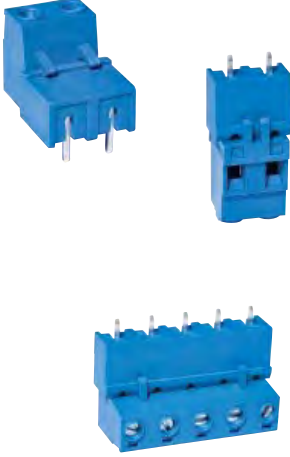

## TAKIM

SOKET BASKILI DEVRE KLEMENSİ (7.62 mm) 2.5 mm<sup>2</sup>

KOD	AÇIKLAMA	AD. / TL	K. AD.
MEGA 232 - SBDK	Soket Baskılı Devre Klemens 2'li (7.62 mm) Takım	1.040	200
MEGA 233 - SBDK	Soket Baskılı Devre Klemens 3'lü (7.62 mm) Takım	1.560	100
MEGA 234 - SBDK	Soket Baskılı Devre Klemens 4'lü (7.62 mm) Takım	2.080	100
MEGA 235 - SBDK	Soket Baskılı Devre Klemens 5'li (7.62 mm) Takım	2.600	100
MEGA 236 - SBDK	Soket Baskılı Devre Klemens 6'lı (7.62 mm) Takım	3.120	100
MEGA 237 - SBDK	Soket Baskılı Devre Klemens 7'li (7.62 mm) Takım	3.640	50
MEGA 238 - SBDK	Soket Baskılı Devre Klemens 8'li (7.62 mm) Takım	4.160	50
MEGA 239 - SBDK	Soket Baskılı Devre Klemens 9'lu (7.62 mm) Takım	4.680	50
MEGA 240 - SBDK	Soket Baskılı Devre Klemens 10'lu (7.62 mm) Takım	5.200	50
MEGA 241 - SBDK	Soket Baskılı Devre Klemens 11'li (7.62 mm) Takım	5.720	50
MEGA 242 - SBDK	Soket Baskılı Devre Klemens 12'li (7.62 mm) Takım	6.240	50

## Dişi

SOKET BASKILI DEVRE KLEMENSİ (7.62 mm) 2.5 mm<sup>2</sup>

KOD	AÇIKLAMA	AD. / TL	K. AD.
MEGA 232 - SBDK-D	Soket Baskılı Devre Klemens 2'li (7.62 mm) Dişi	0.832	200
MEGA 233 - SBDK-D	Soket Baskılı Devre Klemens 3'lü (7.62 mm) Dişi	1.248	100
MEGA 234 - SBDK-D	Soket Baskılı Devre Klemens 4'lü (7.62 mm) Dişi	1.664	100
MEGA 235 - SBDK-D	Soket Baskılı Devre Klemens 5'li (7.62 mm) Dişi	2.080	100
MEGA 236 - SBDK-D	Soket Baskılı Devre Klemens 6'lı (7.62 mm) Dişi	2.496	100
MEGA 237 - SBDK-D	Soket Baskılı Devre Klemens 7'li (7.62 mm) Dişi	2.912	50
MEGA 238 - SBDK-D	Soket Baskılı Devre Klemens 8'li (7.62 mm) Dişi	3.328	50
MEGA 239 - SBDK-D	Soket Baskılı Devre Klemens 9'lu (7.62 mm) Dişi	3.744	50
MEGA 240 - SBDK-D	Soket Baskılı Devre Klemens 10'lu (7.62 mm) Dişi	4.160	50
MEGA 241 - SBDK-D	Soket Baskılı Devre Klemens 11'li (7.62 mm) Dişi	4.576	50
MEGA 242 - SBDK-D	Soket Baskılı Devre Klemens 12'li (7.62 mm) Dişi	4.992	50

## ERKEK

SOKET BASKILI DEVRE KLEMENSİ (7.62 mm) 2.5 mm<sup>2</sup>

KOD	AÇIKLAMA	AD. / ₺	K. AD.
MEGA 232 - SBDK-E	Soket Baskılı Devre Klemens 2'li (7.62 mm) Erkek	0.3120	200
MEGA 233 - SBDK-E	Soket Baskılı Devre Klemens 3'lü (7.62 mm) Erkek	0.4680	100
MEGA 234 - SBDK-E	Soket Baskılı Devre Klemens 4'lü (7.62 mm) Erkek	0.6240	100
MEGA 235 - SBDK-E	Soket Baskılı Devre Klemens 5'li (7.62 mm) Erkek	0.7800	100
MEGA 236 - SBDK-E	Soket Baskılı Devre Klemens 6'lı (7.62 mm) Erkek	0.9360	100
MEGA 237 - SBDK-E	Soket Baskılı Devre Klemens 7'li (7.62 mm) Erkek	1.0920	50
MEGA 238 - SBDK-E	Soket Baskılı Devre Klemens 8'li (7.62 mm) Erkek	1.2480	50
MEGA 239 - SBDK-E	Soket Baskılı Devre Klemens 9'lu (7.62 mm) Erkek	1.4040	50
MEGA 240 - SBDK-E	Soket Baskılı Devre Klemens 10'lu (7.62 mm) Erkek	1.5600	50
MEGA 241 - SBDK-E	Soket Baskılı Devre Klemens 11'li (7.62 mm) Erkek	1.7160	50
MEGA 242 - SBDK-E	Soket Baskılı Devre Klemens 12'li (7.62 mm) Erkek	1.8720	50

## TAKIM

SOKET BASKILI DEVRE KLEMENSİ TAKIM (7.62 mm) 2.5 mm<sup>2</sup>

KOD	AÇIKLAMA	AD. / ʘ	K. AD.
MEGA 282 - SBDK	Soket Baskılı Devre Klemensi Dik (7.62 mm) Takım	1.190	200
MEGA 283 - SBDK	Soket Baskılı Devre Klemensi Dik (7.62 mm) Takım	1.785	100
MEGA 284 - SBDK	Soket Baskılı Devre Klemensi Dik (7.62 mm) Takım	ʘ	-
MEGA 285 - SBDK	Soket Baskılı Devre Klemensi Dik (7.62 mm) Takım	ʘ	-
MEGA 286 - SBDK	Soket Baskılı Devre Klemensi Dik (7.62 mm) Takım	ʘ	-
MEGA 287 - SBDK	Soket Baskılı Devre Klemensi Dik (7.62 mm) Takım	ʘ	-
MEGA 288 - SBDK	Soket Baskılı Devre Klemensi Dik (7.62 mm) Takım	ʘ	-
MEGA 289 - SBDK	Soket Baskılı Devre Klemensi Dik (7.62 mm) Takım	ʘ	-
MEGA 290 - SBDK	Soket Baskılı Devre Klemensi Dik (7.62 mm) Takım	ʘ	-
MEGA 291 - SBDK	Soket Baskılı Devre Klemensi Dik (7.62 mm) Takım	ʘ	-
MEGA 292 - SBDK	Soket Baskılı Devre Klemensi Dik (7.62 mm) Takım	ʘ	-

## DİŞİ

SOKET BASKILI DEVRE KLEMENSİ DİŞİ (7.62 mm) 2.5 mm<sup>2</sup>

KOD	AÇIKLAMA	AD. / ʘ	K. AD.
MEGA 282 - SBDK-D	Soket Baskılı Devre Klemensi Dik (7.62 mm) Dişİ	0.950	200
MEGA 283 - SBDK-D	Soket Baskılı Devre Klemensi Dik (7.62 mm) Dişİ	1.428	100
MEGA 284 - SBDK-D	Soket Baskılı Devre Klemensi Dik (7.62 mm) Dişİ	ʘ	-
MEGA 285 - SBDK-D	Soket Baskılı Devre Klemensi Dik (7.62 mm) Dişİ	ʘ	-
MEGA 286 - SBDK-D	Soket Baskılı Devre Klemensi Dik (7.62 mm) Dişİ	ʘ	-
MEGA 287 - SBDK-D	Soket Baskılı Devre Klemensi Dik (7.62 mm) Dişİ	ʘ	-
MEGA 288 - SBDK-D	Soket Baskılı Devre Klemensi Dik (7.62 mm) Dişİ	ʘ	-
MEGA 289 - SBDK-D	Soket Baskılı Devre Klemensi Dik (7.62 mm) Dişİ	ʘ	-
MEGA 290 - SBDK-D	Soket Baskılı Devre Klemensi Dik (7.62 mm) Dişİ	ʘ	-
MEGA 291 - SBDK-D	Soket Baskılı Devre Klemensi Dik (7.62 mm) Dişİ	ʘ	-
MEGA 292 - SBDK-D	Soket Baskılı Devre Klemensi Dik (7.62 mm) Dişİ	ʘ	-

## ERKEK

SOKET BASKILI DEVRE KLEMENSİ ERKEK İ (7.62 mm) 2.5 mm<sup>2</sup>

KOD	AÇIKLAMA	AD. / ʘ	K. AD.
MEGA 282 - SBDK-E	Soket Baskılı Devre Klemensi Dik (7.62 mm) Erkek	0.312	200
MEGA 283 - SBDK-E	Soket Baskılı Devre Klemensi Dik (7.62 mm) Erkek	0.468	100
MEGA 284 - SBDK-E	Soket Baskılı Devre Klemensi Dik (7.62 mm) Erkek	ʘ	-
MEGA 285 - SBDK-E	Soket Baskılı Devre Klemensi Dik (7.62 mm) Erkek	ʘ	-
MEGA 286 - SBDK-E	Soket Baskılı Devre Klemensi Dik (7.62 mm) Erkek	ʘ	-
MEGA 287 - SBDK-E	Soket Baskılı Devre Klemensi Dik (7.62 mm) Erkek	ʘ	-
MEGA 288 - SBDK-E	Soket Baskılı Devre Klemensi Dik (7.62 mm) Erkek	ʘ	-
MEGA 289 - SBDK-E	Soket Baskılı Devre Klemensi Dik (7.62 mm) Erkek	ʘ	-
MEGA 290 - SBDK-E	Soket Baskılı Devre Klemensi Dik (7.62 mm) Erkek	ʘ	-
MEGA 291 - SBDK-E	Soket Baskılı Devre Klemensi Dik (7.62 mm) Erkek	ʘ	-
MEGA 292 - SBDK-E	Soket Baskılı Devre Klemensi Dik (7.62 mm) Erkek	ʘ	-

## SOKET BASKILI DEVRE KLEMENSİ KATLI ERKEK (7.62 mm)



KOD	AÇIKLAMA	AD. / ʘ	K. AD.
MEGA 232-SBDK-KE	Soket Baskılı Devre Klemensi K. Erkek 2 x 2'li (7.62 mm)	0.8680	100
MEGA 233-SBDK-KE	Soket Baskılı Devre Klemensi K. Erkek 2 x 3'li (7.62 mm)	1.3020	50

## TAKIM

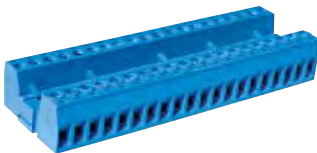
SOKET KABLO BİRLEŞTİRİCİ KLEMENSİ (5.08 mm) 2,5 mm<sup>2</sup>

KOD	AÇIKLAMA	AD. / ʘ	K. AD.
MEGA 502 - SKBK	Soket Kablo Birleştirici Klemens 2'li (5.08 mm) Takım	1.420	200
MEGA 503 - SKBK	Soket Kablo Birleştirici Klemens 3'lü (5.08 mm) Takım	2.130	100
MEGA 504 - SKBK	Soket Kablo Birleştirici Klemens 4'lü (5.08 mm) Takım	2.840	100
MEGA 505 - SKBK	Soket Kablo Birleştirici Klemens 5'li (5.08 mm) Takım	3.550	100
MEGA 506 - SKBK	Soket Kablo Birleştirici Klemens 6'lı (5.08 mm) Takım	4.260	100
MEGA 507 - SKBK	Soket Kablo Birleştirici Klemens 7'li (5.08 mm) Takım	4.970	100
MEGA 508 - SKBK	Soket Kablo Birleştirici Klemens 8'li (5.08 mm) Takım	5.680	100
MEGA 509 - SKBK	Soket Kablo Birleştirici Klemens 9'lu (5.08 mm) Takım	6.390	100
MEGA 510 - SKBK	Soket Kablo Birleştirici Klemens 10'lu (5.08 mm) Takım	7.100	50
MEGA 511 - SKBK	Soket Kablo Birleştirici Klemens 11'li (5.08 mm) Takım	7.810	50
MEGA 512 - SKBK	Soket Kablo Birleştirici Klemens 12'li (5.08 mm) Takım	8.520	50
MEGA 513 - SKBK	Soket Kablo Birleştirici Klemens 13'lü (5.08 mm) Takım	9.230	50
MEGA 514 - SKBK	Soket Kablo Birleştirici Klemens 14'lü (5.08 mm) Takım	9.940	50
MEGA 515 - SKBK	Soket Kablo Birleştirici Klemens 15'li (5.08 mm) Takım	10.650	50
MEGA 516 - SKBK	Soket Kablo Birleştirici Klemens 16'lı (5.08 mm) Takım	11.360	50
MEGA 517 - SKBK	Soket Kablo Birleştirici Klemens 17'li (5.08 mm) Takım	12.070	50
MEGA 518 - SKBK	Soket Kablo Birleştirici Klemens 18'li (5.08 mm) Takım	12.780	50
MEGA 519 - SKBK	Soket Kablo Birleştirici Klemens 19'lu (5.08 mm) Takım	13.490	50
MEGA 520 - SKBK	Soket Kablo Birleştirici Klemens 20'li (5.08 mm) Takım	14.200	50
MEGA 521 - SKBK	Soket Kablo Birleştirici Klemens 21'li (5.08 mm) Takım	14.910	50
MEGA 522 - SKBK	Soket Kablo Birleştirici Klemens 22'li (5.08 mm) Takım	15.620	50
MEGA 523 - SKBK	Soket Kablo Birleştirici Klemens 23'lü (5.08 mm) Takım	16.330	50
MEGA 524 - SKBK	Soket Kablo Birleştirici Klemens 24'lü (5.08 mm) Takım	17.040	50
MEGA 525 - SKBK	Soket Kablo Birleştirici Klemens 25'li (5.08 mm) Takım	17.750	50

## Dişi

SOKET KABLO BİRLEŞTİRİCİ KLEMENSİ (5.08 mm) 2,5 mm<sup>2</sup>

KOD	AÇIKLAMA	AD. / ʘ	K. AD.
MEGA 502 - SKBK-D	Soket Kablo Birleştirici Klemens 2'li (5.08 mm) Dişi	0.616	200
MEGA 503 - SKBK-D	Soket Kablo Birleştirici Klemens 3'lü (5.08 mm) Dişi	0.924	100
MEGA 504 - SKBK-D	Soket Kablo Birleştirici Klemens 4'lü (5.08 mm) Dişi	1.232	100
MEGA 505 - SKBK-D	Soket Kablo Birleştirici Klemens 5'li (5.08 mm) Dişi	1.540	100
MEGA 506 - SKBK-D	Soket Kablo Birleştirici Klemens 6'lı (5.08 mm) Dişi	1.848	100
MEGA 507 - SKBK-D	Soket Kablo Birleştirici Klemens 7'li (5.08 mm) Dişi	2.156	100
MEGA 508 - SKBK-D	Soket Kablo Birleştirici Klemens 8'li (5.08 mm) Dişi	2.464	100
MEGA 509 - SKBK-D	Soket Kablo Birleştirici Klemens 9'lu (5.08 mm) Dişi	2.772	100
MEGA 510 - SKBK-D	Soket Kablo Birleştirici Klemens 10'lu (5.08 mm) Dişi	3.080	50
MEGA 511 - SKBK-D	Soket Kablo Birleştirici Klemens 11'li (5.08 mm) Dişi	3.388	50
MEGA 512 - SKBK-D	Soket Kablo Birleştirici Klemens 12'li (5.08 mm) Dişi	3.696	50
MEGA 513 - SKBK-D	Soket Kablo Birleştirici Klemens 13'lü (5.08 mm) Dişi	4.004	50
MEGA 514 - SKBK-D	Soket Kablo Birleştirici Klemens 14'lü (5.08 mm) Dişi	4.312	50
MEGA 515 - SKBK-D	Soket Kablo Birleştirici Klemens 15'li (5.08 mm) Dişi	4.620	50
MEGA 516 - SKBK-D	Soket Kablo Birleştirici Klemens 16'lı (5.08 mm) Dişi	4.928	50
MEGA 517 - SKBK-D	Soket Kablo Birleştirici Klemens 17'li (5.08 mm) Dişi	5.236	50
MEGA 518 - SKBK-D	Soket Kablo Birleştirici Klemens 18'li (5.08 mm) Dişi	5.544	50
MEGA 519 - SKBK-D	Soket Kablo Birleştirici Klemens 19'lu (5.08 mm) Dişi	5.852	50
MEGA 520 - SKBK-D	Soket Kablo Birleştirici Klemens 20'li (5.08 mm) Dişi	6.160	50
MEGA 521 - SKBK-D	Soket Kablo Birleştirici Klemens 21'li (5.08 mm) Dişi	6.468	50
MEGA 522 - SKBK-D	Soket Kablo Birleştirici Klemens 22'li (5.08 mm) Dişi	6.776	50
MEGA 523 - SKBK-D	Soket Kablo Birleştirici Klemens 23'lü (5.08 mm) Dişi	7.084	50
MEGA 524 - SKBK-D	Soket Kablo Birleştirici Klemens 24'lü (5.08 mm) Dişi	7.392	50
MEGA 525 - SKBK-D	Soket Kablo Birleştirici Klemens 25'li (5.08 mm) Dişi	7.700	50

## ERKEK

SOKET KABLO BİRLEŞTİRİCİ KLEMENSİ (5.08 mm) 2,5 mm<sup>2</sup>

KOD	AÇIKLAMA	AD. / ʘ	K. AD.
MEGA 502 - SKBK-E	Soket Kablo Birleştirici Klemens 2'li (5.08 mm) Erkek	0.804	200
MEGA 503 - SKBK-E	Soket Kablo Birleştirici Klemens 3'lü (5.08 mm) Erkek	1.206	100
MEGA 504 - SKBK-E	Soket Kablo Birleştirici Klemens 4'lü (5.08 mm) Erkek	1.608	100
MEGA 505 - SKBK-E	Soket Kablo Birleştirici Klemens 5'li (5.08 mm) Erkek	2.010	100
MEGA 506 - SKBK-E	Soket Kablo Birleştirici Klemens 6'lı (5.08 mm) Erkek	2.412	100
MEGA 507 - SKBK-E	Soket Kablo Birleştirici Klemens 7'li (5.08 mm) Erkek	2.814	100
MEGA 508 - SKBK-E	Soket Kablo Birleştirici Klemens 8'li (5.08 mm) Erkek	3.216	100
MEGA 509 - SKBK-E	Soket Kablo Birleştirici Klemens 9'lu (5.08 mm) Erkek	3.618	100
MEGA 510 - SKBK-E	Soket Kablo Birleştirici Klemens 10'lu (5.08 mm) Erkek	4.020	50
MEGA 511 - SKBK-E	Soket Kablo Birleştirici Klemens 11'li (5.08 mm) Erkek	4.422	50
MEGA 512 - SKBK-E	Soket Kablo Birleştirici Klemens 12'li (5.08 mm) Erkek	4.824	50
MEGA 513 - SKBK-E	Soket Kablo Birleştirici Klemens 13'lü (5.08 mm) Erkek	5.226	50
MEGA 514 - SKBK-E	Soket Kablo Birleştirici Klemens 14'lü (5.08 mm) Erkek	5.628	50
MEGA 515 - SKBK-E	Soket Kablo Birleştirici Klemens 15'li (5.08 mm) Erkek	6.030	50
MEGA 516 - SKBK-E	Soket Kablo Birleştirici Klemens 16'lı (5.08 mm) Erkek	6.432	50
MEGA 517 - SKBK-E	Soket Kablo Birleştirici Klemens 17'li (5.08 mm) Erkek	6.834	50
MEGA 518 - SKBK-E	Soket Kablo Birleştirici Klemens 18'li (5.08 mm) Erkek	7.236	50
MEGA 519 - SKBK-E	Soket Kablo Birleştirici Klemens 19'lu (5.08 mm) Erkek	7.638	50
MEGA 520 - SKBK-E	Soket Kablo Birleştirici Klemens 20'li (5.08 mm) Erkek	8.040	50
MEGA 521 - SKBK-E	Soket Kablo Birleştirici Klemens 21'li (5.08 mm) Erkek	8.442	50
MEGA 522 - SKBK-E	Soket Kablo Birleştirici Klemens 22'li (5.08 mm) Erkek	8.844	50
MEGA 523 - SKBK-E	Soket Kablo Birleştirici Klemens 23'lü (5.08 mm) Erkek	9.246	50
MEGA 524 - SKBK-E	Soket Kablo Birleştirici Klemens 24'lü (5.08 mm) Erkek	9.648	50
MEGA 525 - SKBK-E	Soket Kablo Birleştirici Klemens 25'li (5.08 mm) Erkek	10.050	50

VİDASIZ BASKILI DEVRE KLEMENSİ 1,5 mm<sup>2</sup>

KOD	AÇIKLAMA	AD. / ʘ	K. AD.
MEGA 302 - VBDK	Vidasız Baskılı Devre Klemensi 2'li (5.08 x 7.62mm)	0.460	200
MEGA 303 - VBDK	Vidasız Baskılı Devre Klemensi 3'lü (5.08 x 7.62mm)	0.690	100
MEGA 304 - VBDK	Vidasız Baskılı Devre Klemensi 4'lü (5.08 x 7.62mm)	0.920	100
MEGA 305 - VBDK	Vidasız Baskılı Devre Klemensi 5'li (5.08 x 7.62mm)	1.150	100
MEGA 306 - VBDK	Vidasız Baskılı Devre Klemensi 6'li (5.08 x 7.62mm)	1.380	100
MEGA 307 - VBDK	Vidasız Baskılı Devre Klemensi 7'li (5.08 x 7.62mm)	1.610	100
MEGA 308 - VBDK	Vidasız Baskılı Devre Klemensi 8'li (5.08 x 7.62mm)	1.840	100
MEGA 309 - VBDK	Vidasız Baskılı Devre Klemensi 9'lu (5.08 x 7.62mm)	2.070	100
MEGA 310 - VBDK	Vidasız Baskılı Devre Klemensi 10'lu (5.08 x 7.62mm)	2.300	50
MEGA 311 - VBDK	Vidasız Baskılı Devre Klemensi 11'li (5.08 x 7.62mm)	2.530	50
MEGA 310 - VBDK	Vidasız Baskılı Devre Klemensi 12'li (5.08 x 7.62mm)	2.760	50

## MODÜLER BASKILI DEVRE KLEMENSİ (5.08 mm)



KOD	AÇIKLAMA	AD. / ʘ	K. AD.
MEGA 02-MBDK	M.B. Devre Klemens No: 0 2'li (5,08 mm) 1.5 mm <sup>2</sup>	0.230	500
MEGA 103-MBDK	M.B. Devre Klemens No: 0 3'lü (5,08 mm) 1.5 mm <sup>2</sup>	0.345	500
MEGA 112-MBDK	M.B. Devre Klemens No: 1 2'li (5,08 mm) 2.5 mm <sup>2</sup>	0.384	250
MEGA 113-MBDK	M.B. Devre Klemens No: 1 3'lü (5,08 mm) 2.5 mm <sup>2</sup>	0.576	250
MEGA 122-MBDK	M.B. Devre Klemens No: 2 2'li (5,08 mm) 4 mm <sup>2</sup>	0.576	100
MEGA 123-MBDK	M.B. Devre Klemens No: 2 3'lü (5,08 mm) 4 mm <sup>2</sup>	0.864	100
MEGA 130-MBDK	M.B. Devre Klemens No: 2 10'lu (5,08 mm) 4 mm <sup>2</sup>	2.880	50

MODÜLER BASKILI DEVRE KLEMENSİ (7.62 mm) 4 mm<sup>2</sup>

KOD	AÇIKLAMA	AD. / ʘ	K. AD.
MEGA 132-MBDK	M.B. Devre Klemens No: 2 2'li (7,62 mm) 4 mm <sup>2</sup>	0.806	100
MEGA 133-MBDK	M.B. Devre Klemens No: 2 3'lü (7,62 mm) 4 mm <sup>2</sup>	1.290	100

MODÜLER BASKILI DEVRE KLEMENSİ (9.52 x 7.62 mm) 6 mm<sup>2</sup>

KOD	AÇIKLAMA	AD. / ʘ	K. AD.
MEGA 141-MBDK	Modüler Baskılı Devre Klemensi	1.692	100

BASKILI DEVRE KLEMENSİ (GÜÇ KLEMENSİ) (3.81 x 15.24 mm) 16 mm<sup>2</sup>

KOD	AÇIKLAMA	AD. / ʘ	K. AD.
MEGA 433 - BDK	Baskılı Devre Klemensi (Güç Klemensi)	10.542	10

MODÜLER BASKILI DEVRE KLEMENSİ (10.16 x 10.16 mm) 10 mm<sup>2</sup>

KOD	AÇIKLAMA	AD. / ʘ	K. AD.
MEGA 421-MBDK	Modüler Baskılı Devre Klemensi	2.626	100



### MODÜLER BASKILI DEVRE KLEMENSİ (10.16 x 12.7 mm) 10 mm<sup>2</sup>

KOD	AÇIKLAMA	AD. / 7	K. AD.
MEGA 422-MBDK	Modüler Baskılı Devre Klemensİ	2.875	100



### KABLO BİRLEŐTİRİCİ RAY DİSTANS

KOD	AÇIKLAMA	AD. / 7	K. AD.
MEGA 409-KBRD	Kablo Birleřtirici Ray Distans	0.834	100



### BASKILI DEVRE SİGORTA YUVASI

KOD	AÇIKLAMA	AD. / 7	K. AD.
MEGA 401-BDSY/K	Baskılı Devre Sigorta Yuvası Kapaklı	0.230	500
MEGA 401-BDSY	Baskılı Devre Sigorta Yuvası Kapaksız	0.192	500

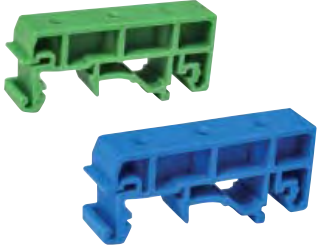

### RAY DİSTANS

KOD	AÇIKLAMA	AD. / 7	K. AD.
MEGA 410-RD	Raydistans Kart Yükseltici	0.78	100



### MODÜLER KART YUVASI

KOD	AÇIKLAMA	AD. / 7	K. AD.
MEGA 411-MKYK	Modüler Kart Yuvası Kapak	0.767	50
MEGA 411-MKYA	Modüler Kart Yuvası Ayak	0.959	50
MEGA 411-MKYM	Modüler Kart Yuvası Modül	1.246	50



### KART YUVASI

KOD	AÇIKLAMA	AD. / 7	K. AD.
MEGA 413-72KYK	72 mm Kart Yuvası Kapak + 100 Adet Vida	0.959	50
MEGA 413-72KYA	72 mm Kart Yuvası Ayak	1.246	50
MEGA 413-72KYP	72 mm Kart Yuvası, Profil 2m	43.200	1
MEGA 413-72KYP	72 mm Kart Yuvası, Profil 1m	21.600	1
MEGA 414-108KYK	108 mm Kart Yuvası Kapak + 100 Adet Vida	1.150	50
MEGA 414-108KYA	108 mm Kart Yuvası Ayak	1.534	50
MEGA 414-108KYP	108 mm Kart Yuvası, Profil 2m	51.800	1
MEGA 414-108KYP	108 mm Kart Yuvası, Profil 1m	25.900	1

# SIOKE

# repol<sup>®</sup> S.A.

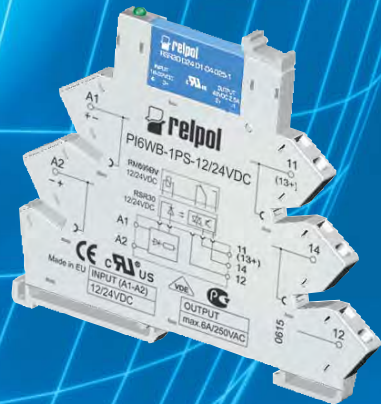

## MİNYATÜR RÖLE

## 1 KONTAK 5 PIN MİNYATÜR RÖLE (FASTON TİPİ BACAKLI)



JQX-14FT-1C

KOD	CİNSİ	AD. / \$	K./AD.
SLOK-JQX-14FT-1C-12VDC	12 V DC	2.85 \$	50
SLOK-JQX-14FT-1C-24VDC	24 V DC	2.85 \$	50
SLOK-JQX-14FT-1C-48VDC	48 V DC	3.12 \$	50
SLOK-JQX-14FT-1C-110VDC	110 V DC	5.19 \$	50
SLOK-JQX-14FT-1C-24VAC	24 V AC	4.41 \$	50
SLOK-JQX-14FT-1C-230VAC	230 V AC	4.80 \$	50

## 2 KONTAK 8 PIN MİNYATÜR RÖLE (YASSI BACAKLI)



JQX-14FT-2C

KOD	CİNSİ	AD. / \$	K./AD.
SLOK-JQX-14FT-2C-12VDC	12 V DC	3.00 \$	50
SLOK-JQX-14FT-2C-24VDC	24 V DC	3.00 \$	50
SLOK-JQX-14FT-2C-48VDC	48 V DC	3.33 \$	50
SLOK-JQX-14FT-2C-110VDC	110 V DC	5.49 \$	50
SLOK-JQX-14FT-2C-24VAC	24 V AC	4.65 \$	50
SLOK-JQX-14FT-2C-230VAC	230 V AC	5.00 \$	50

## MİNYATÜR RÖLE

## 1 KONTAK 8 PIN MİNYATÜR RÖLE (İĞNE BACAKLI)



JQX-14FC-1CH

KOD	CİNSİ	AD. / \$	K./AD.
SLOK-JQX-14FC-1CH-12VDC	12 V DC	2.43 \$	50
SLOK-JQX-14FC-1CH-24VDC	24 V DC	2.43 \$	50
SLOK-JQX-14FC-1CH-48VDC	48 V DC	2.76 \$	50
SLOK-JQX-14FC-1CH-110VDC	110 V DC	5.49 \$	50
SLOK-JQX-14FC-1CH-24VAC	24 V AC	5.58 \$	50
SLOK-JQX-14FC-1CH-230VAC	230 V AC	5.00 \$	50

## 2 KONTAK 8 PIN MİNYATÜR RÖLE (İĞNE BACAKLI)



JQX-14FC-2C

KOD	CİNSİ	AD. / \$	K./AD.
SLOK-JQX-14FC-2C-12VDC	12 V DC	2.43 \$	50
SLOK-JQX-14FC-2C-24VDC	24 V DC	2.43 \$	50
SLOK-JQX-14FC-2C-48VDC	48 V DC	2.79 \$	50
SLOK-JQX-14FC-2C-110VDC	110 V DC	5.49 \$	50
SLOK-JQX-14FC-2C-24VAC	24 V AC	2.46 \$	50
SLOK-JQX-14FC-2C-230VAC	230 V AC	5.00 \$	50

## 2 KONTAK 8 PIN ENDÜSTRİYEL TİP RÖLE (LED'Lİ VE T. BUTONLU)



JQX-13F-KF2CL

KOD	CİNSİ	AD. / \$	K./AD.
SLOK-JQX-13F-KF2CL-12VDC	12 V DC	3.90 \$	20
SLOK-JQX-13F-KF2CL-24VDC	24 V DC	4.05 \$	20
SLOK-JQX-13F-KF2CL-48VDC	48 V DC	4.65 \$	20
SLOK-JQX-13F-KF2CL-110VDC	110 V DC	4.65 \$	20
SLOK-JQX-13F-KF2CL-24VAC	24 V AC	4.68 \$	20
SLOK-JQX-13F-KF2CL-230VAC	230 V AC	4.44 \$	20

## 4 KON. 14 PIN ENDÜSTRİYEL TİP RÖLE (LED'Lİ VE T. BUTONLU)



JQX-13F-KF4CL

KOD	CİNSİ	AD. / \$	K./AD.
SLOK-JQX-13F-KF4CL-12VDC	12 V DC	3.96 \$	20
SLOK-JQX-13F-KF4CL-24VDC	24 V DC	4.05 \$	20
SLOK-JQX-13F-KF4CL-48VDC	48 V DC	4.65 \$	20
SLOK-JQX-13F-KF4CL-110VDC	110 V DC	4.65 \$	20
SLOK-JQX-13F-KF4CL-24VAC	24 V AC	4.65 \$	20
SLOK-JQX-13F-KF4CL-230VAC	230 V AC	4.44 \$	20

## SLİM RÖLE (TEK)



KOD	CİNSİ	AD. / \$	K./AD.
SLOK-RNC-12VDC	12 V DC	50	50
SLOK-RNC-24VDC	24 V DC	50	50
SLOK-RNC-48VDC	48 V DC	50	50
SLOK-RNC-110VDC	110 V DC	50	50
SLOK-RNC-24VAC	24 V AC	50	50
SLOK-RNC-230VAC	230 V AC	50	50

## 2 KONTAK 8 PIN ENDÜSTRİYEL TİP RÖLE (LED'Lİ VE T. BUTONLU)



MK2P

KOD	CİNSİ	AD. / \$	K./AD.
SLOK-MK2P-12VDC	12 V DC	5.64 \$	20
SLOK-MK2P-24VDC	24 V DC	6.18 \$	20
SLOK-MK2P-48VDC	48 V DC	6.18 \$	20
SLOK-MK2P-110VDC	110 V DC	6.18 \$	20
SLOK-MK2P-24VAC	24 V AC	6.18 \$	20
SLOK-MK2P-230VAC	230 V AC	5.97 \$	20

## 3 KON. 11 PIN ENDÜSTRİYEL TİP RÖLE (LED'Lİ VE T. BUTONLU)



MK3P

KOD	CİNSİ	AD. / \$	K./AD.
SLOK-MK3P-12VDC	12 V DC	6.69 \$	20
SLOK-MK3P-24VDC	24 V DC	6.09 \$	20
SLOK-MK3P-48VDC	48 V DC	6.99 \$	20
SLOK-MK3P-110VDC	110 V DC	6.99 \$	20
SLOK-MK3P-24VAC	24 V AC	6.99 \$	20
SLOK-MK3P-230VAC	230 V AC	6.51 \$	20

## AKSESUARLAR



KOD	CİNSİ	AD. / \$	K./AD.
SLOK-SKB14-E	R4 14 PIN RÖLE İÇİN SOKET	3.33 \$	10
SLOK-SKC11-E	R3 11 PIN RÖLE İÇİN SOKET	3.48 \$	10
SLOK-SKB08-E	R2 8 PIN RÖLE İÇİN SOKET	2.88 \$	10
SLOK-SRC08-E	5mm PIN ARALIĞI İĞNE BACAKLI RÖLE İÇİN SOKET	2.70 \$	10
SLOK-SRC05-E	5mm PIN ARALIĞI, 5 PIN RÖLE İÇİN SOKET	2.43 \$	10
SLOK-SRU08-E	YASSI BACAK 8PİN İKİ KONTAK RÖLE İÇİN SOKET	2.76 \$	10
SLOK-SUB08-E	8 PIN RÖLE İÇİN SOKET (YUVARLAK PIN)	2.76 \$	10
SLOK-SUB011-E	11 PIN RÖLE İÇİN SOKET (YUVARLAK PIN)	3.18 \$	10
SLOK-SRU05-E	FASTON TİPİ TEK KONTAK RÖLE İÇİN SOKET	2.61 \$	10
SLOK-SRC08-P	5mm PIN ARALIĞI, PCB KARTA MONTAJ 8 PIN İĞNE BACAKLI SOKET	0.93 \$	20
SLOK-SNC05	SLİM RÖLE İÇİN PCB KARTA MONTAJ SOKET	1.68 \$	20
SLOK-SNC05-E	SLİM RÖLE SOKET VİDA BASKILI	4.68 \$	20
SLOK-SNC05-S	SLİM RÖLE SOKET YAY BASKILI	4.68 \$	20
SLOK-AMD-L1	6/24V DC LED MODÜL (YEŞİL LEDLİ)	1.17 \$	10
SLOK-AMD-L1	110/230V AC/DC LED MODÜL (YEŞİL LEDLİ)	1.17 \$	10
SLOK-SR25C	AÇMA KLİPSİ (SRU VE SRC SERİSİ SOKETLER İÇİN)	0.15 \$	10
SLOK-SK36F	AÇMA KLİPSİ (SKB VE SKC SERİSİ SOKETLER İÇİN)	0.18 \$	5
SLOK-SN20B	SLİM RÖLE İÇİN 20'Lİ KÖPRÜ	1.89 \$	10
SLOK-SR2025M	RÖLE SABİTLEME TELİ	0.18 \$	10



### VİDA BASKILI SLIM RÖLE + SOKET (1KONTAK 6 A)



KOD	CİNSİ	AD. / €	K. / AD.
REL-PIR6W-1PS-24VDC-R	24VDC	11.13 €	10
REL-PIR6W-1PS-24VAC/DC-R	24V AC/DC	11.13 €	10
REL-PIR6W-1PS-48VDC-R	48V DC	11.46 €	10
REL-PIR6W-1PS-115VAC/DC-R	115V AC/DC	12.00 €	10
REL-PIR6W-1PS-230VAC/DC-R	230VAC/DC	12.12 €	10

### YAY BASKILI SLIM RÖLE + SOKET



KOD	CİNSİ	AD./€	K. / AD.
REL-PIR6WB-1PS-24VDC-R	24VDC	11.52 €	10
REL-PIR6WB-1PS-24VAC/DC-R	24V AC/DC	11.52 €	10
REL-PIR6WB-1PS-48VDC-R	48V DC	14.82 €	10
REL-PIR6WB-1PS-115VAC/DC-R	115V AC/DC	14.82 €	10
REL-PIR6WB-1PS-230VAC/DC-R	230VAC/DC	14.82 €	10

### (SSR) SOLID STATE SLIM RÖLE

### OPTOKUPLOR VİDA BASKILI SLIM RÖLE + SOKET



KOD	CİNSİ	AD./€	K. / AD.
REL-PIR6W-1PS-24VDC-C	24VDC	21,69 €	10
REL-PIR6W-1PS-24VAC/DC-C	24V AC/DC	21,69 €	10
REL-PIR6W-1PS-48VDC-C	48V DC	23,40 €	10
REL-PIR6W-1PS-115VAC/DC-C	115V AC/DC	23,40 €	10
REL-PIR6W-1PS-230VAC/DC-C	230VAC/DC	24,00 €	10

### OPTOKUPLOR YAY BASKILI SLIM RÖLE + SOKET



KOD	CİNSİ	AD./€	K. / AD.
REL-PIR6WB-1PS-24VDC-T	24VDC	25,95 €	10
REL-PIR6WB-1PS-24VAC/DC-T	24V AC/DC	18,87 €	10
REL-PIR6WB-1PS-48VDC-T	48V DC	22,26 €	10
REL-PIR6WB-1PS-115VAC/DC-T	115V AC/DC	19,68 €	10
REL-PIR6WB-1PS-230VAC/DC-C	230VAC/DC	19,68 €	10

### SLİM RÖLELER İÇİN AKSESUARLAR

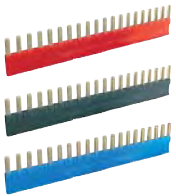

KOD	CİNSİ	AD./€	K. / AD.
REL- ZG20-1	KÖPRÜ 20 Lİ, KIRMIZI RENK	3,72 €	10
REL- ZG20-2	KÖPRÜ 20 Lİ, SİYAH RENK	3,72 €	10
REL- ZG20-3	KÖPRÜ 20 Lİ, MAVİ RENK	3,72 €	10
REL- PI6W-1246	MARKALAMA	10	10

### GÜNEŞ ENERJİ SİSTEMLERİNDE GÜÇ KONTROL RÖLE



KOD	CİNSİ	AD. / €
REL-RS35-3022-25-1005	35A/5V DC	13,08 €
REL-RS35-3022-25-1009	35A/9V DC	13,68 €
REL-RS35-3022-25-1012	35A/12V DC	13,59 €
REL-RS35-3022-25-1018	35A/18V DC	13,86 €
REL-RS35-3022-25-1024	35A/24V DC	13,62 €
REL-RS35-3022-25-1100	35A/110V DC	15,51 €
REL-RS50-3022-25-1005	50A/5V DC	15,90 €
REL-RS50-3022-25-1009	50A/9V DC	16,56 €
REL-RS50-3022-25-1012	50A/12V DC	16,47 €
REL-RS50-3022-25-1018	50A/18V DC	16,80 €
REL-RS50-3022-25-1024	50A/24V DC	16,53 €
REL-RS50-3022-25-1100	50A/110V DC	18,75 €

### MİNYATÜR RÖLE

### 2 KONTAK 8 PİN MİNYATÜR RÖLE (İĞNE BACAĞLI) 8A



KOD	CİNSİ	AD. / €	K. / AD.
REL- RM84-2012-25-1012	12 V DC	1,98 €	20
REL- RM84-2012-25-1024	24 V DC	1,98 €	20
REL- RM84-2012-25-1048	48 V DC	2,82 €	20
REL- RM84-2012-25-1110	110 V DC	3,54 €	20
REL- RM84-2012-25-5024	24 V AC	2,73 €	20
REL- RM84-2012-25-5230	230 V AC	4,62 €	20

### 1 KONTAK 8 PİN MİNYATÜR RÖLE (İĞNE BACAĞLI) 16 A



KOD	CİNSİ	AD. / €	K. / AD.
REL- RM85-2011-25-1012	12 V DC	1,71 €	20
REL- RM85-2011-25-1024	24 V DC	1,71 €	20
REL- RM85-2011-25-1048	48 V DC	2,16 €	20
REL- RM85-2011-25-1110	110 V DC	2,73 €	20
REL- RM85-2011-25-5024	24 V AC	2,37 €	20
REL- RM85-2011-25-5230	230 V AC	4,23 €	20

### 1 KONTAK 5 PİN MİNYATÜR RÖLE (İĞNE BACAĞLI) 12 A



KOD	CİNSİ	AD. / €	K. / AD.
REL- RM87N-2011-25-1012	12 V DC	1,77 €	20
REL- RM87N-2011-25-1024	24 V DC	1,77 €	20
REL- RM87N-2011-25-1048	48 V DC	2,16 €	20
REL- RM87N-2011-25-1110	110 V DC	2,73 €	20
REL- RM87N-2011-25-5024	24 V AC	2,34 €	20
REL- RM87N-2011-25-5230	230 V AC	4,23 €	20

### AKSESUARLAR



KOD	CİNSİ	AD. / €	K. / AD.
REL-GZM80 BLACK	RM84, RM85 İçin Raya Montajlı Soket (8 PIN)	2,46 €	10
REL-GZT80 BLACK	RM84, RM85 İçin Raya Montajlı Soket (8 PIN)	2,52 €	10
REL-GZS80 BLACK	RM84, RM85 İçin Raya Montajlı Soket (8 PIN) Kısa Tip	2,22 €	10
REL-GZM92 BLACK	RM87N İçin Raya Montajlı Soket (5 PIN)	2,46 €	10
REL-GZT92 BLACK	RM87N İçin Raya Montajlı Soket (5 PIN)	2,52 €	10
REL-GZS92 BLACK	RM87N İçin Raya Montajlı Soket (5 PIN) Kısa Tip	2,16 €	10
REL-GD50 BLACK	RM84, RM85 İçin PCB Karta Montaj Soket (8 PIN)	0,78 €	200
REL-GD35 BLACK	RM87N İçin PCB Karta Montaj Soket (5 PIN)	0,78 €	200
REL-GZT80-0040	GZM80, GZM92 İçin Açma Klipsi (Siyah)	0,60 €	10
REL-GZT80-0035	HAREK. Markalama (GZM80, GZM92 Soketler İçin)	0,66 €	10

## ENDÜSTRİYEL RÖLE

## 2 KONTAK 8 PİN ENDÜSTRİYEL TİP RÖLE / 12 A



KOD	CİNSİ	AD. / €	K. / AD.
RELP - R2-2012-23-1012-WT	12 V DC	4,38 €	10
RELP - R2-2012-23-1024-WT	24 V DC	4,38 €	10
RELP - R2-2012-23-1048-WT	48 V DC	4,68 €	10
RELP - R2-2012-23-1110-WT	110 V DC	4,77 €	10
RELP - R2-2012-23-1220-WT	220 V DC	8,37 €	10
RELP - R2-2012-23-5024-WT	24 V AC	4,56 €	10
RELP - R2-2012-23-5220-WT	220 V AC	5,01 €	10
RELP - R2-2012-23-5230-WT	230 V AC	5,01 €	10

## 3 KONTAK 11 PİN ENDÜSTRİYEL TİP RÖLE / 10 A



KOD	CİNSİ	AD. / €	K. / AD.
RELP - R3-2013-23-1012-WT	12 V DC	4,47 €	10
RELP - R3-2013-23-1024-WT	24 V DC	4,47 €	10
RELP - R3-2013-23-1048-WT	48 V DC	4,89 €	10
RELP - R3-2013-23-1110-WT	110 V DC	4,89 €	10
RELP - R3-2013-23-1220-WT	220 V DC	8,58 €	10
RELP - R3-2013-23-5024-WT	24 V AC	4,47 €	10
RELP - R3-2013-23-5220-WT	220 V AC	5,07 €	10
RELP - R3-2013-23-5230-WT	230 V AC	5,04 €	10

## 4 KONTAK 14 PİN ENDÜSTRİYEL TİP RÖLE / 6 A



KOD	CİNSİ	AD. / €	K. / AD.
RELP - R4-2014-23-1012-WT	12 V DC	4,26 €	10
RELP - R4-2014-23-1024-WT	24 V DC	4,26 €	10
RELP - R4-2014-23-1048-WT	48 V DC	5,16 €	10
RELP - R4-2014-23-1110-WT	110 V DC	4,68 €	10
RELP - R4-2014-23-1220-WT	220 V DC	8,22 €	10
RELP - R4-2014-23-5024-WT	24 V AC	4,26 €	10
RELP - R4-2014-23-5220-WT	220 V AC	5,76 €	10
RELP - R4-2014-23-5230-WT	230 V AC	4,68 €	10

## 2 KON. 8 PİN ENDÜSTRİYEL TİP LEDLİ RÖLE 10 A (YUVARLAK PİN)



KOD	CİNSİ	AD. / €	K. / AD.
RELP - R15-2012-23-1024-WTL	24 V DC	6,78 €	10
RELP - R15-2012-23-1048-WTL	48 V DC	7,29 €	10
RELP - R15-2012-23-1110-WTL	110 V DC	7,14 €	10
RELP - R15-2012-23-1220-WTL	220 V DC	9,51 €	10
RELP - R15-2012-23-5024-WTL	24 V AC	6,78 €	10
RELP - R15-2012-23-5230-WTL	230 V AC	7,14 €	10

## 3 KON. 11 PİN ENDÜSTRİYEL TİP LEDLİ RÖLE 10 A (YUVARLAK PİN)



KOD	CİNSİ	AD. / €	K. / AD.
RELP - R15-2013-23-1024-WTL	24 V DC	7,14 €	10
RELP - R15-2013-23-1048-WTL	48 V DC	7,29 €	10
RELP - R15-2013-23-1110-WTL	110 V DC	7,44 €	10
RELP - R15-2013-23-1220-WTL	220 V DC	10,02 €	10
RELP - R15-2013-23-5024-WTL	24 V AC	7,29 €	10
RELP - R15-2013-23-5230-WTL	230 V AC	7,77 €	10

## 4 KONTAK 14 PİN ENDÜSTRİYEL TİP RÖLE (YUVARLAK PİN)



KOD	CİNSİ	AD. / €	K. / AD.
RELP - R15-1014-23-1024	24 V DC	11,55 €	10
RELP - R15-1014-23-1048	48 V DC	12,06 €	10
RELP - R15-1014-23-1110	110 V DC	12,06 €	10
RELP - R15-1014-23-1220	220 V DC	16,02 €	10
RELP - R15-1014-23-3024	24 V AC	11,46 €	10
RELP - R15-1014-23-3230	230 V AC	12,48 €	10

## ENDÜSTRİYEL TİP RÖLELER İÇİN AKSESUARLAR



KOD	CİNSİ	AD. / €	K. / AD.
RELP - GZM2 BLACK	R2 İçin Soket	2,85 €	10
RELP - GZM3 BLACK	R3 İçin Soket	3,45 €	10
RELP - GZM4 BLACK	R4 İçin Soket	3,21 €	10
RELP - GZT2 BLACK	R2 İçin Soket Kısa Tip	2,58 €	10
RELP - GZT3 BLACK	R3 İçin Soket Kısa Tip	2,85 €	10
RELP - GZT4 BLACK	R4 İçin Soket Kısa Tip	3,21 €	10
RELP - GZP8 BLACK	R15 8 Pin Röle İçin Soket (Yuvarlak Pin)	2,16 €	10
RELP - GZP11 BLACK	R15 11 Pin Röle İçin Soket (Yuvarlak Pin)	2,46 €	10
RELP - GZS8 BLACK	R15 8 Pin Röle İçin Soket (Yuvarlak Pin) Kısa Tip	1,20 €	10
RELP - GZS11 BLACK	R15 11 Pin Röle İçin Soket (Yuvarlak Pin) Kısa Tip	1,38 €	10
RELP - GZ14U WHITE	R15 14 Pin Röle İçin Soket (Yuvarlak Pin)	6,48 €	10
RELP - GZT4-0040	GZM80, GZM92 İçin Açma Klipse (Siyah)	0,27 €	10
RELP - GZT4-0035	Haraketli Markalama (GZM2, GZM3, GZM4 Soketler İçin)	0,27 €	10

## KIRMIZI LEDLİ DİY. MOD. (GZT, GZM VE GZS SER. SOKETLER İÇİN)



KOD	CİNSİ	AD. / €	K. / AD.
RELP - Module M31R	6/24V DC	3,93 €	20
RELP - Module M33R	110/230V DC	3,93 €	20
RELP - Module M61R	6/24V AC/DC	2,49 €	20
RELP - Module M63R	110/230V AC/DC	2,70 €	20

## YEŞİL LEDLİ DİY. MOD. (GZT, GZM VE GZS SER. SOKETLER İÇİN)





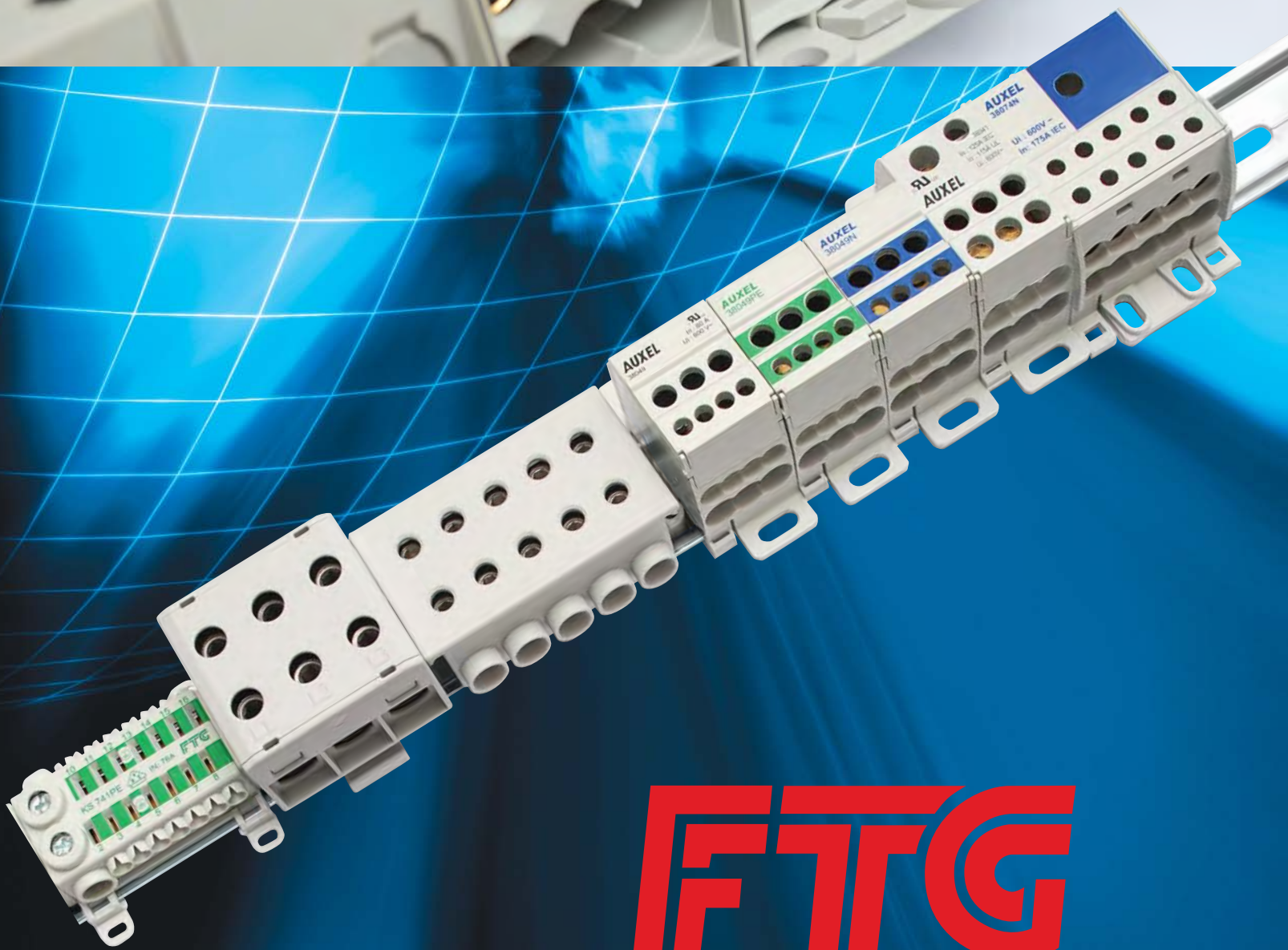

KOD	CİNSİ	AD. / €	K. / AD.
RELP - Module M31G	6/24V DC	3,93 €	20
RELP - Module M33G	110/230V DC	3,93 €	20
RELP - Module M61G	6/24V AC/DC	2,49 €	20
RELP - Module M63G	110/230V AC/DC	2,70 €	20











**FTTG**

## GÜÇ DAĞITIM BLOKLARI

## MONOBLOK DAĞITICI

	KOD	CİNSİ	AD./€	K. / AD.
	FTG-38049	80 A, Giriş: 1 x 2,5-16 mm <sup>2</sup> Çıkış: 4 x 2,5 - 6 mm <sup>2</sup> 2 x 2,5 - 16 mm <sup>2</sup>	11,50 €	1
	FTG-38049 PE	80 A Yeşil Giriş: 1 x 2,5 - 16 mm <sup>2</sup> Çıkış: 2 x 2,5 - 6 mm <sup>2</sup> 2 x 2,5 - 16 mm <sup>2</sup>	11,50 €	1
	FTG-38049 N	80 A Mavi Giriş: 1 x 2,5 - 16 mm <sup>2</sup> Çıkış: 2 x 2,5 - 6 mm <sup>2</sup> 2 x 2,5 - 16 mm <sup>2</sup>	11,50 €	1
	FTG-38041	125 A, Giriş: 1 x 10-35 mm <sup>2</sup> Çıkış: 1 x 2,5 - 16 mm <sup>2</sup> 6 x 2,5 - 16 mm <sup>2</sup>	22,00 €	1
	FTG-38041 PE	125 A, Giriş: 1 x 10-35 mm <sup>2</sup> Çıkış: 1 x 2,5 - 16 mm <sup>2</sup> 6 x 2,5 - 16 mm <sup>2</sup>	22,00 €	1
	FTG-38041 N	125 A, Giriş: 1 x 10-35 mm <sup>2</sup> Çıkış: 1 x 2,5 - 16 mm <sup>2</sup> 6 x 2,5 - 16 mm <sup>2</sup>	22,00 €	1
	FTG-38032	160 A, Giriş: 1 x 10-70 mm <sup>2</sup> Çıkış: 6 x 2,5 - 16 mm <sup>2</sup> 5 x 15 mm <sup>2</sup> Bakır Bara Geçişli	33,50 €	1
	FTG-38074	175 A, Giriş: 1 x 16-70 mm <sup>2</sup> Çıkış: 10 x 2,5 - 16 mm <sup>2</sup>	29,00 €	1
	FTG-38074 N	175 A Mavi Giriş: 1 x 16 - 70 mm <sup>2</sup> Çıkış: 10 x 2,5 - 16 mm <sup>2</sup>	29,00 €	1
	FTG-38020	250 A Giriş: 1 x 35 - 120 mm <sup>2</sup> Çıkış: 2 x 6 - 35 mm <sup>2</sup> 5 x 1,5 - 16 mm <sup>2</sup> 4x1,5-10 mm <sup>2</sup>	44,00 €	1
	FTG-38019	400 A, Giriş: 1x95-185 mm <sup>2</sup> Çıkış: 2 x 6 - 35 mm <sup>2</sup> 5 x 1,5 - 16 mm <sup>2</sup> 4 x 1,5 - 10 mm <sup>2</sup>	47,00 €	1

## MONOBLOK DAĞITICI

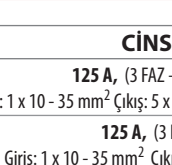
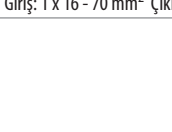
	KOD	CİNSİ	AD./€	K. / AD.
	FTG-38404	400 A Giriş: 1 x 95 - 240 mm <sup>2</sup> Çıkış: 2 x 50 - 120 mm <sup>2</sup>	41.00 €	1
	FTG-38404N	400 A Giriş: 1 x 95 - 240 mm <sup>2</sup> Çıkış: 2 x 50 - 120 mm <sup>2</sup>	41.00 €	1
	FTG-38404PE	400 A Giriş: 1 x 95 - 240 mm <sup>2</sup> Çıkış: 2 x 50 - 120 mm <sup>2</sup>	41.00 €	1
	FTG-38404R	400 A Giriş: 1 x 95 - 240 mm <sup>2</sup> Çıkış: 2 x 50 - 120 mm <sup>2</sup>	41.00 €	1
	FTG-38403	400 A Giriş: 1 x 95 - 240 mm <sup>2</sup> Çıkış: 6 x 10 - 50 mm <sup>2</sup>	42.00 €	1
	FTG-38403N	400 A Giriş: 1 x 95 - 240 mm <sup>2</sup> Çıkış: 6 x 10 - 50 mm <sup>2</sup>	42.00 €	1
	FTG-38403PE	400 A Giriş: 1 x 95 - 240 mm <sup>2</sup> Çıkış: 6 x 10 - 50 mm <sup>2</sup>	42.00 €	1
	FTG-38403R	400 A Giriş: 1 x 95 - 240 mm <sup>2</sup> Çıkış: 6 x 10 - 50 mm <sup>2</sup>	42.00 €	1
	FTG-38402	400 A Giriş: 1 x 250 mm <sup>2</sup> Çıkış: 2 x 50 - 120 mm <sup>2</sup>	42.00 €	1
	FTG-38401	400 A Giriş: 1 x 250 mm <sup>2</sup> Çıkış: 6 x 10 - 50 mm <sup>2</sup>	43.50 €	1
	FTG-38062	800 A Bir Giriş İki Çıkış Bara Girişi 1 x 35-300 mm <sup>2</sup> Çıkış 2 x 35-300 mm <sup>2</sup>	66.50 €	1
	FTG-38063	800 A İki Giriş İki Çıkış Giriş 2 x 35-300 mm <sup>2</sup> Çıkış 2 x 35-300 mm <sup>2</sup>	66.50 €	1

## 3 FAZLI MONOBLOK DAĞITICI



KOD	CİNSİ	AD./€	K. / AD.
FTG-38056	125 A, (3 FAZ + NÖTR) Giriş: 1 x 10 - 35 mm <sup>2</sup> Çıkış: 5 x 1,5 - 6, 2 x 2,5 - 16 mm <sup>2</sup>	30.50 €	1
FTG-38075	125 A, (3 FAZ) Giriş: 1 x 10 - 35 mm <sup>2</sup> Çıkış: 6 x 2,5 - 16 mm <sup>2</sup>	62.50 €	1
FTG-38073	175 A (3 FAZ) Giriş: 1 x 16 - 70 mm <sup>2</sup> Çıkış: 6 x 2,5 - 16 mm <sup>2</sup>	57.00 €	1



## EK ALMA KLEMENLERİ

KOD	CİNSİ	AD./ €	K. / AD.
FTG-KNT 1316İ	3 x 1,5-10 mm <sup>2</sup> İzoleli	9.00 €	1
FTG-KNT 1316IU	3 x 1,5-16 mm <sup>2</sup> İzoleli	10.50 €	1

## VİDA VE YAY BASKILI MODÜLER SİSTEM DAĞITICI ÜNİTE



KOD	CİNSİ	AD./ €	K. / AD.
FTG-KS741	2 x 25 mm <sup>2</sup> - 14 x 4 mm <sup>2</sup> 76A / 690V / Gri	7.50 €	10
FTG-KS741N	2 x 25 mm <sup>2</sup> - 14 x 4 mm <sup>2</sup> 76A / 690V / Mavi	7.50 €	10
FTG-KS741PE	2 x 25 mm <sup>2</sup> - 14 x 4 mm <sup>2</sup> 76A / 690V / Yeşil	7.50 €	10
FTG-KS741NPE	1 x 16 mm <sup>2</sup> - 7 x 4 mm <sup>2</sup> 76A / 690V / Mavi Yeşil	7.50 €	10
FTG-KS741NN	1 x 16 mm <sup>2</sup> - 7 x 4 mm <sup>2</sup> 76A / 690V / Mavi	7.50 €	10
FTG-KS741RN	1 x 16 mm <sup>2</sup> - 7 x 4 mm <sup>2</sup> 76A / 690V / Kırmızı Mavi	7.50 €	10

## GÜÇ DAĞITIM BLOKLARI

## TEK GİRİŞ TEK ÇIKIŞ DAĞITICI



KOD	CİNSİ	GİRİŞ ÇIKIŞ	KABLO KESİTİ ARALIĞI	AKIM	AD./ €	K. / AD.
FTG-KVIAC11150G	2 x Al/Cu, 25 x 150 mm <sup>2</sup> Gri	1/1	25 - 150 mm <sup>2</sup>	315/250	21,50 €	20
FTG-KVIAC11150B	2 x Al/Cu, 25 x 150 mm <sup>2</sup> Mavi	1/1	25 - 150 mm <sup>2</sup>	315/250	21,50 €	10
FTG-KVIAC11150YG	2 x Al/Cu, 25 x 150 mm <sup>2</sup> Sarı / Yeşil	1/1	25 - 150 mm <sup>2</sup>	315/250	22,50 €	10
FTG-KVIAC11240G	2 x Al/Cu, 35 x 240 mm <sup>2</sup> Gri	1/1	35 - 240 mm <sup>2</sup>	400/315	40,00 €	10
FTG-KVIAC11240B	2 x Al/Cu, 35 x 240 mm <sup>2</sup> Sarı / Mavi	1/1	35 - 240 mm <sup>2</sup>	400/315	40,00 €	3
FTG-KVIAC11240YG	2 x Al/Cu, 35 x 240 mm <sup>2</sup> Sarı / Yeşil	1/1	35 - 240 mm <sup>2</sup>	400/315	41,00 €	3
FTG-KVIAC12150G	2 x 315 A İki Giriş, İki Çıkış, 2 x 25-150 mm <sup>2</sup>	2/2	25 - 150 mm <sup>2</sup>	315/315	45,00 €	1
FTG-KVIAC12240G	2 x 400 A, İki Giriş, İki Çıkış, 2 x 35 - 240 mm <sup>2</sup>	2/2	35 - 240 mm <sup>2</sup>	400/400	76,50 €	1

## ÜÇ GİRİŞ ÜÇ ÇIKIŞ DAĞITICI



KOD	CİNSİ	GİRİŞ ÇIKIŞ	KABLO KESİTİ ARALIĞI	AKIM	AD./ €	K. / AD.
FTG-KVIAC31050G	6 x Al/Cu, 1,5 - 50 mm <sup>2</sup> Gri	3 x 1/3 x 1	2,5 - 50 mm <sup>2</sup>	3 x 160 / 125	20,00 €	20

## İKİ GİRİŞ İKİ ÇIKIŞ DAĞITICI



KVIAC12150B

KOD	CİNSİ	GİRİŞ ÇIKIŞ	KABLO KESİTİ ARALIĞI	AKIM	AD./ €	K. / AD.
FTG-KVIAC12050G	4 x Al/Cu, 2,5 - 50 mm <sup>2</sup> Gri	2/2	2,5 - 50 mm <sup>2</sup>	2 x 160 / 125	15,50 €	15
FTG-KVIAC12050B	4 x Al/Cu, 2,5 - 50 mm <sup>2</sup> Mavi	2/2	2,5 - 50 mm <sup>2</sup>	2 x 160 / 125	16,00 €	15
FTG-KVIAC12050YG	4 x Al/Cu, 2,5 - 50 mm <sup>2</sup> Sarı / Yeşil	2/2	2,5 - 50 mm <sup>2</sup>	2 x 160 / 125	16,00 €	15
FTG-KVIAC12095G	4 x Al/Cu, 6 - 95 mm <sup>2</sup> Gri	2/2	6 - 95 mm <sup>2</sup>	2 x 250 / 200	26,50 €	30
FTG-KVIAC12095B	4 x Al/Cu, 6 - 95 mm <sup>2</sup> Mavi	2/2	6 - 95 mm <sup>2</sup>	2 x 250 / 200	27,50 €	15
FTG-KVIAC12095YG	4 x Al/Cu, 6 - 95 mm <sup>2</sup> Sarı / Yeşil	2/2	6 - 95 mm <sup>2</sup>	2 x 250 / 200	27,50 €	15

## DİĞER GİRİŞ ÇIKIŞ ALTERNATİFLERİ

KVIAC12050YG



KVIAC51016G

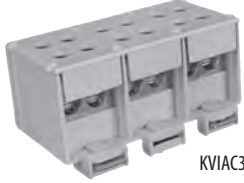

KVIAC32035G

KOD	CİNSİ	GİRİŞ ÇIKIŞ	KABLO KESİTİ ARALIĞI	AKIM	AD./€	K. / AD.
FTG-KVIAC12150G	4 x Al/Cu, 25 - 150 mm <sup>2</sup> Gri	1/1	25 - 150 mm <sup>2</sup>	2 x 315 / 250	47.50 €	10
FTG-KVIAC12150B	4 x Al/Cu, 25 - 150 mm <sup>2</sup> Mavi	2/2	25 - 150 mm <sup>2</sup>	2 x 315 / 250	49.00 €	5
FTG-KVIAC12150YG	4 x Al/Cu, 25 - 150 mm <sup>2</sup> Sarı / Yeşil	2/2	25 - 150 mm <sup>2</sup>	2 x 315 / 250	49.00 €	5
FTG-KVIAC12240G	4 x Al/Cu, 35 - 240 mm <sup>2</sup> Gri	2/2	35 - 240 mm <sup>2</sup>	2 x 400 / 315	75.00 €	6
FTG-KVIAC12240B	4 x Al/Cu, 35 - 240 mm <sup>2</sup> Mavi	2/2	35 - 240 mm <sup>2</sup>	2 x 400 / 315	81.50 €	3
FTG-KVIAC12240YG	4 x Al/Cu, 35 - 240 mm <sup>2</sup> Sarı / Yeşil	2/2	35 - 240 mm <sup>2</sup>	2 x 400 / 315	81.50 €	3
FTG-KVIAC12035G	4 x Al/Cu, 2.5 x 35 mm <sup>2</sup> Gri	2/2	6 - 35 mm <sup>2</sup>	2 x 125 / 100	19.00 €	30
FTG-KVIAC12035B	4 x Al/Cu, 2.5 x 35 mm <sup>2</sup> Mavi	2/2	6 - 35 mm <sup>2</sup>	2 x 125 / 100	19.50 €	15
FTG-KVIAC12035YG	4 x Al/Cu, 2.5 x 35 mm <sup>2</sup> Sarı / Yeşil	2/2	6 - 35 mm <sup>2</sup>	2 x 125 / 100	19.50 €	15
FTG-KVIAC14016G	4 x Al/Cu, 2.5 x 16 mm <sup>2</sup> Gri	4 x Flexibel	2.5 - 16 mm <sup>2</sup>	200 / 160	17.00 €	30
FTG-KVIAC14016B	2 x Al/Cu, 2.5 x 16 mm <sup>2</sup> Mavi	4 x Flexibel	2.5 - 16 mm <sup>2</sup>	200 / 160	18.00 €	15
FTG-KVIAC14016YG	2 x Al/Cu, 2.5 x 16 mm <sup>2</sup> Sarı / Yeşil	4 x Flexibel	2.5 - 16 mm <sup>2</sup>	200 / 160	18.00 €	15
FTG-KVIAC51016G	10 x Al/Cu, 2.5 x 16 mm <sup>2</sup> Gri	5 x 1 / 5 x 1	2.5 - 16 mm <sup>2</sup>	5 x 80 / 63	26.00 €	10
FTG-KVIAC51016B	4 x Al/Cu, 2.5 x 16 mm <sup>2</sup> Mavi	2x2Flexibel	2.5 - 16 mm <sup>2</sup>	2 x 100 / 80	27.00 €	30
FTG-KVIAC51016YG	12 x Al/Cu, 2.5 x 35 mm <sup>2</sup> Yeşil	3 x 1 / 3 x 2	2.5 - 35 mm <sup>2</sup>	3x2x160/125	27.00 €	30
FTG-KVIAC32035G	12 x Al/Cu, 2.5 x 35 mm <sup>2</sup> Gri	3 x 2 / 3 x 2	2.5 - 35 mm <sup>2</sup>	125 Amper	41.00 €	1

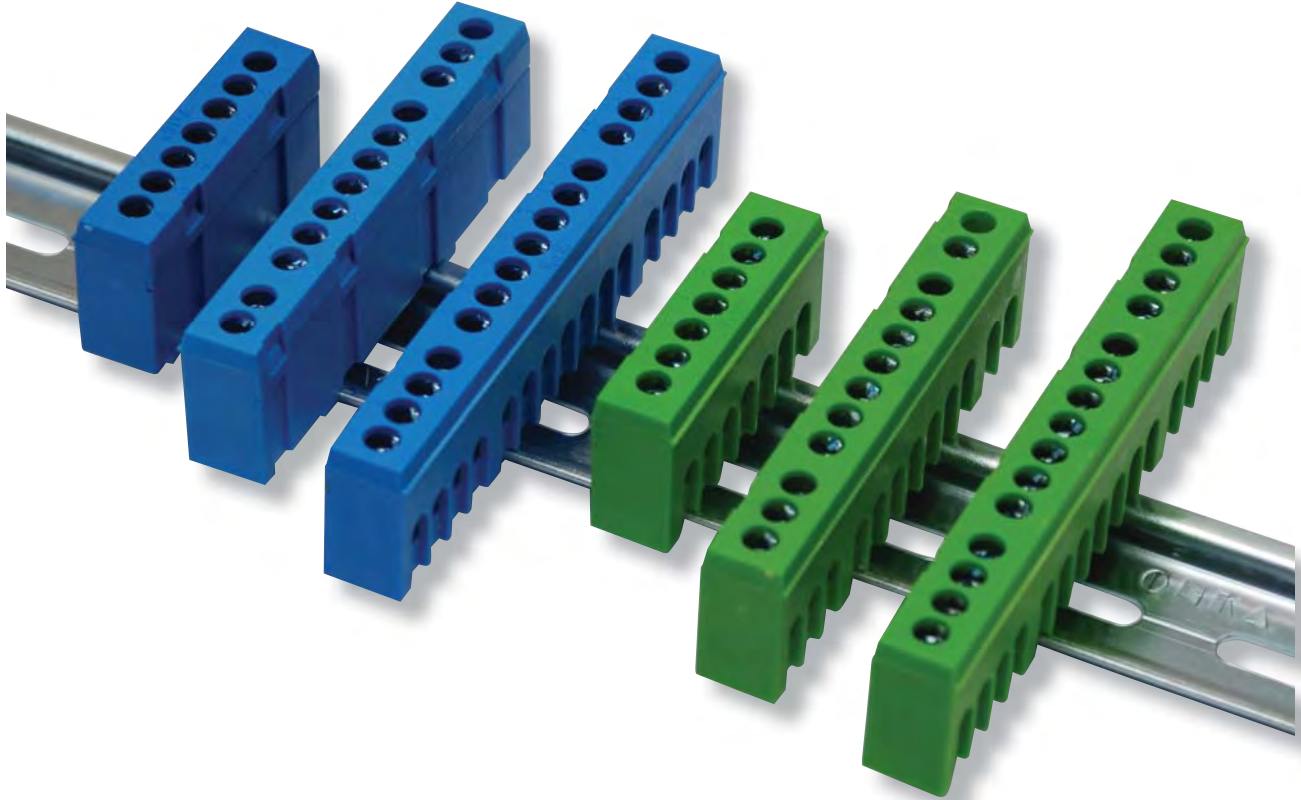

## KOMPLE İZOLELİ DAĞITICI ÜNİTELER



KOD	CİNSİ	KABLO KESİTİ	AD./€	K. / AD.
FTG-870 N/7FS	7 x 16 mm <sup>2</sup> Mavi Komple İzoleli Dağıtıcı Ünite	16 mm <sup>2</sup>	2.50 €	10
FTG-870 S/7FS	7 x 16 mm <sup>2</sup> Yeşil/Sarı Komple İzoleli Dağıtıcı Ünite	16 mm <sup>2</sup>	2.50 €	10
FTG-870 N/15S	15 x 16 mm <sup>2</sup> Mavi Komple İzoleli Dağıtıcı Ünite	16 mm <sup>2</sup>	4.50 €	10
FTG-870 S/15S	15 x 16 mm <sup>2</sup> Yeşil/Sarı Komple İzoleli Dağıtıcı Ünite	16 mm <sup>2</sup>	4.50 €	10

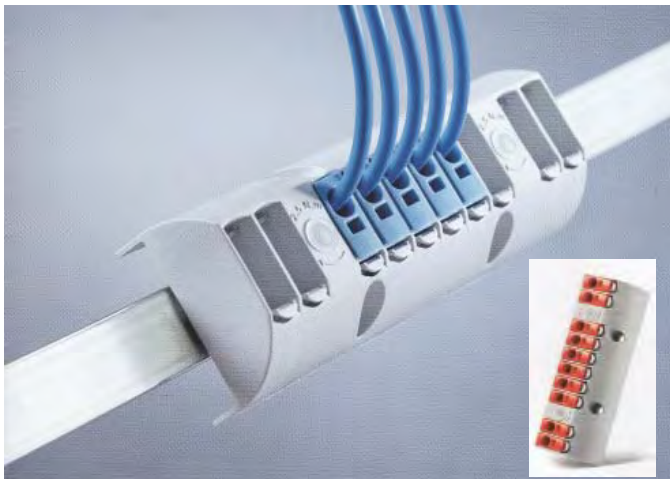
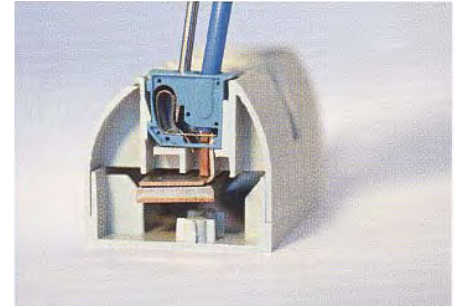
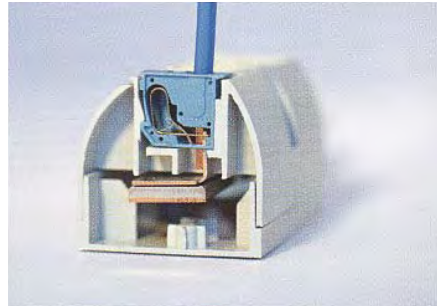
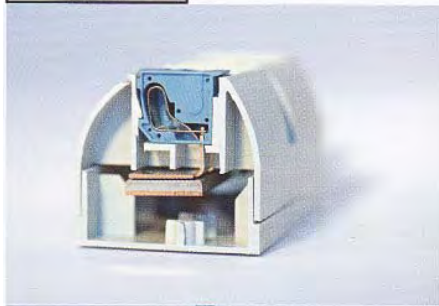
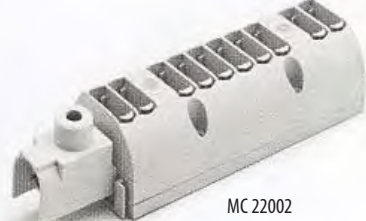
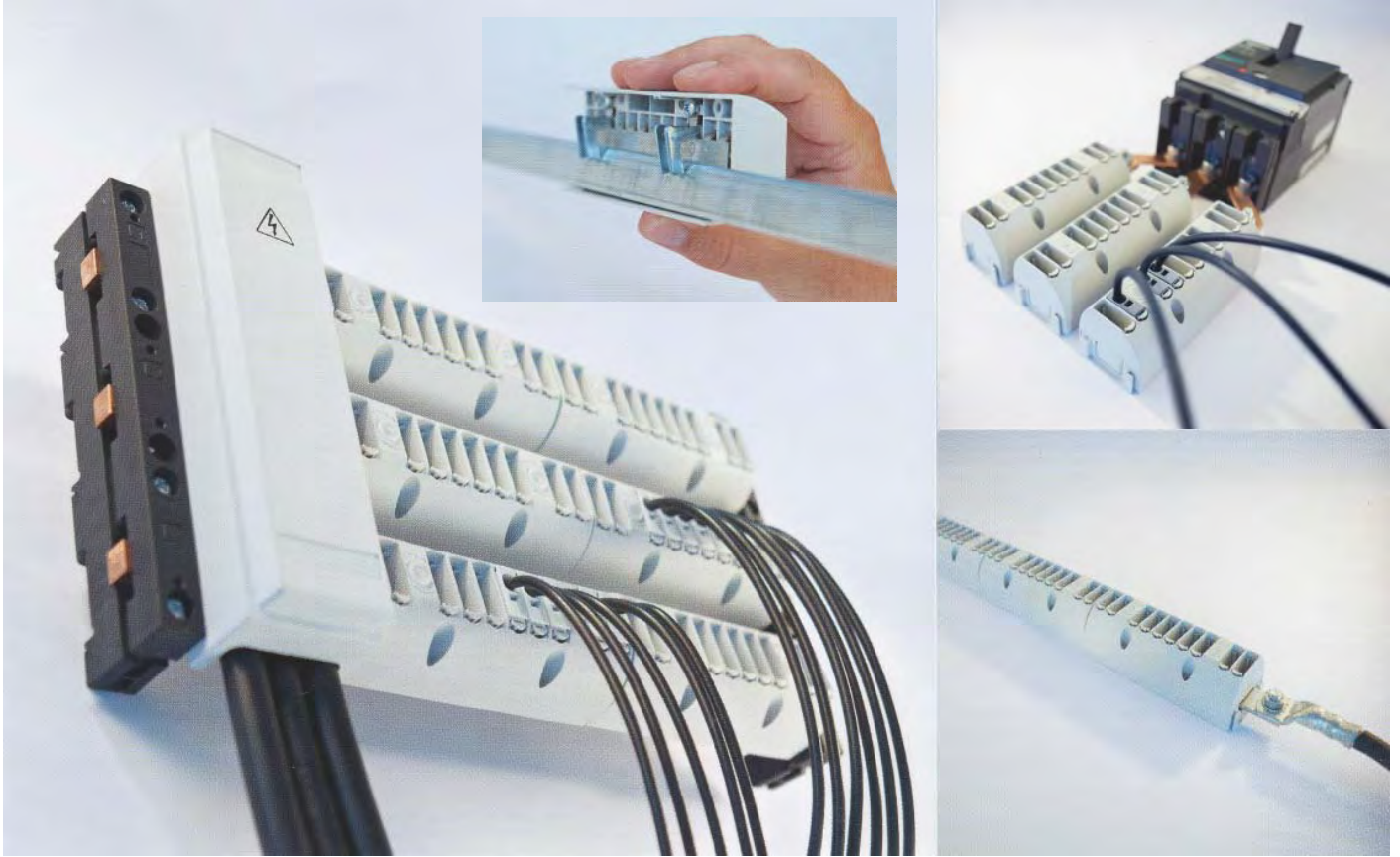

### MINI CLIC

KOD	ÇİNSİ	AD./ €	K. / AD.
FTG-MC 22001	Mini Clic Basis	16.50 €	1
FTG-MC 22002	Mini Clic Incomer, Giriş 25 - 120 mm <sup>2</sup>	30.00 €	1
FTG-MC 22003	Mini Clic Pin, Giriş M8	27.00 €	1
FTG-MC 00001	Mini Clic Cube Grey, Kablo Kesiti 1,5 - 10 mm <sup>2</sup>	1.40 €	10
FTG-MC 00001 N	Mini Clic Cube Blue, Kablo Kesiti 1,5 - 10 mm <sup>2</sup>	1.40 €	10
FTG-MC 00001 PE	Mini Clic Cube Green, Kablo Kesiti 1,5 - 10 mm <sup>2</sup>	1.40 €	10
FTG-MC 00001 R	Mini Clic Cube Red, Kablo Kesiti 1,5 - 10 mm <sup>2</sup>	1.40 €	10

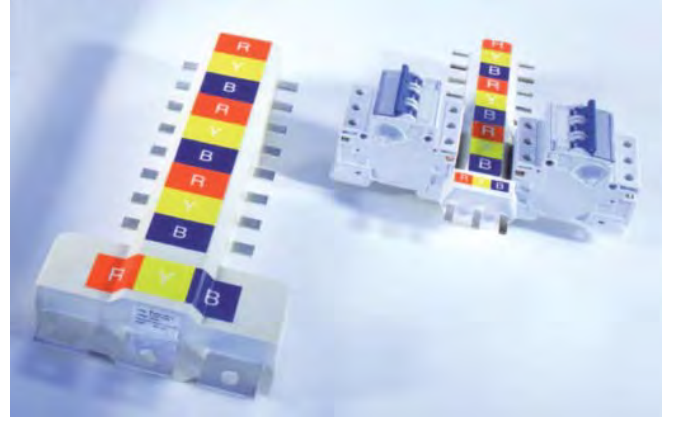
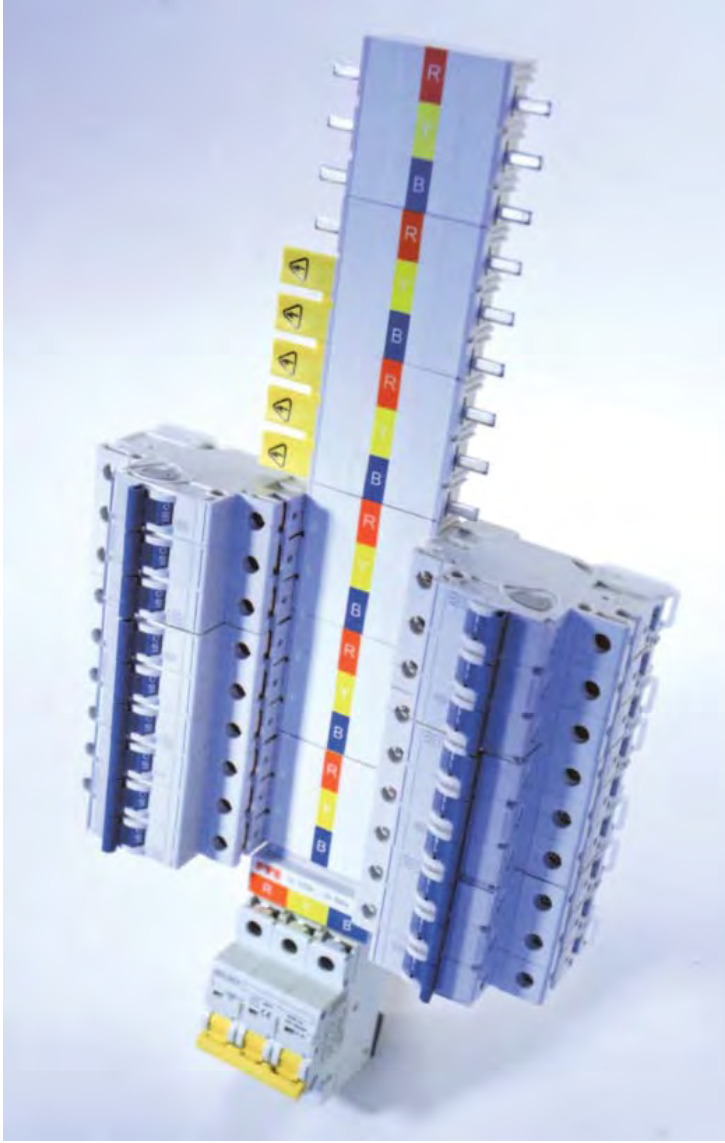

### HAVA YALITIMLI BUSBARLAR



KOD	CİNSİ	AD./€	K. / AD.
FTG-A106M3P18P00-01	125 A, 6 Yollu Hava Yalıtımlı Busbar	45.50 €	10
FTG-A108M3P18P00-01	125 A, 8 Yollu Hava Yalıtımlı Busbar	60.00 €	10
FTG-A110M3P18P00-01	125 A, 10 Yollu Hava Yalıtımlı Busbar	72.50 €	4
FTG-A206M3P18P00-01	250 A, 6 Yollu Hava Yalıtımlı Busbar	61.50 €	10
FTG-A208M3P18P00-01	250 A, 8 Yollu Hava Yalıtımlı Busbar	77.00 €	10
FTG-A210M3P18P00-01	250 A, 10 Yollu Hava Yalıtımlı Busbar	96.50 €	10

Not: 12 ... 24 yollu hava yalıtımlı busbar alternatifleri bulunmaktadır. ⚡

### REÇİNELİ BUSBARLAR



KOD	CİNSİ	AD./€	K. / AD.
FTG-B106M3P18P00-01	125 A, 6 Yollu Reçineli Busbar	116.00 €	10
FTG-B108M3P18P00-01	125 A, 8 Yollu Reçineli Busbar	137.00 €	10
FTG-B112M3P18P00-01	125 A, 10 Yollu Reçineli Busbar	150.00 €	10
FTG-B206M3L35P00-01	250 A, 6 Yollu Reçineli Busbar	197.00 €	1
FTG-B208M3L35P00-01	250 A, 8 Yollu Reçineli Busbar	197.00 €	1
FTG-B212M3L35P00-01	250 A, 10 Yollu Reçineli Busbar	230.00 €	1

Not: 12 ... 24 yollu Reçineli busbar alternatifleri bulunmaktadır. ⚡



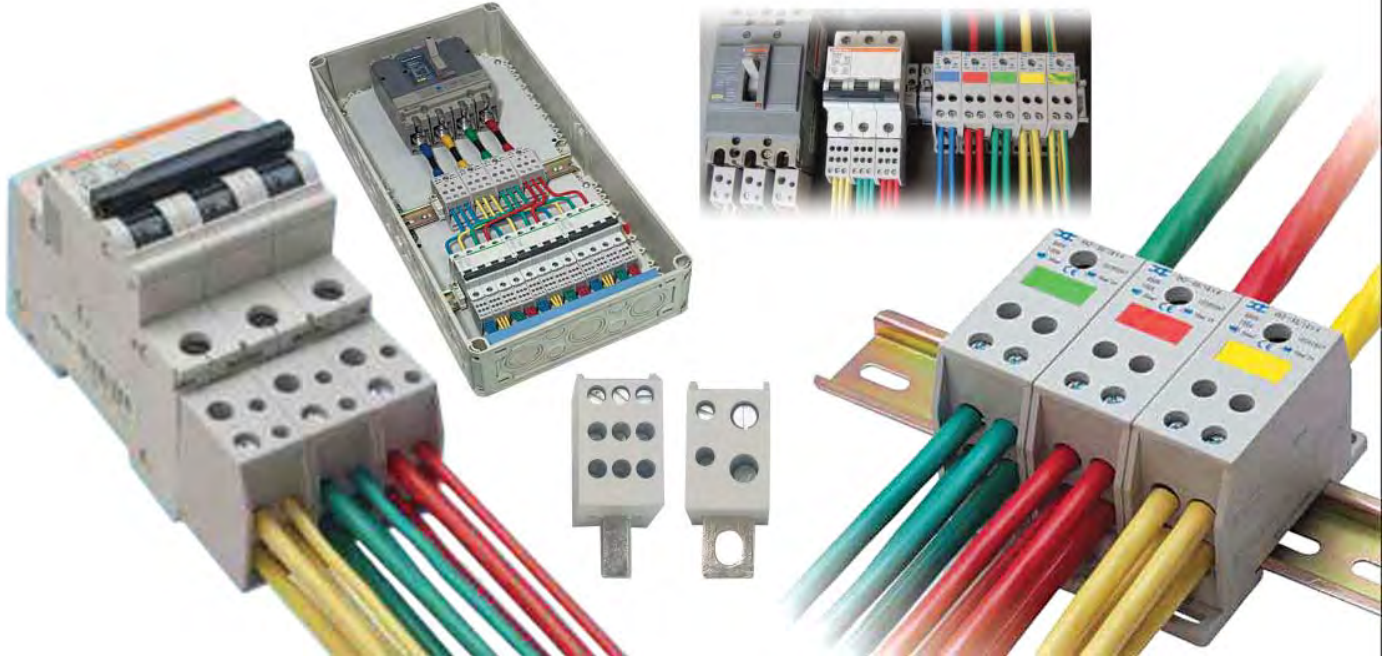
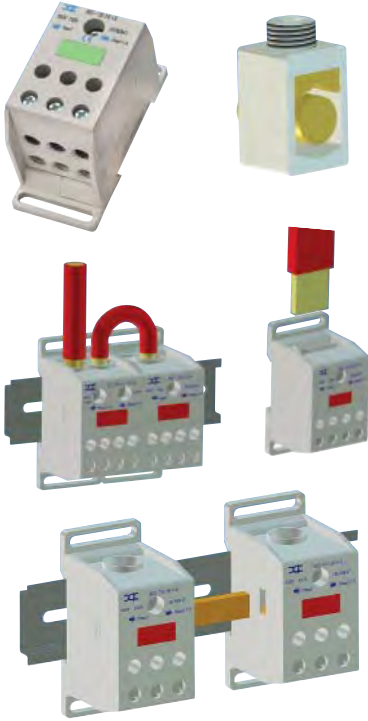

**GÜÇ DAĞITIM BLOKLARI VE GÜÇ KLEMENLERİ**

**Renk Kodları**

<span style="color: yellow;">■</span> - Y	<span style="color: blue;">■</span> - B
<span style="color: green;">■</span> - G	<span style="color: yellow;">■</span> - YG
<span style="color: red;">■</span> - R	<span style="color: grey;">■</span> - LG

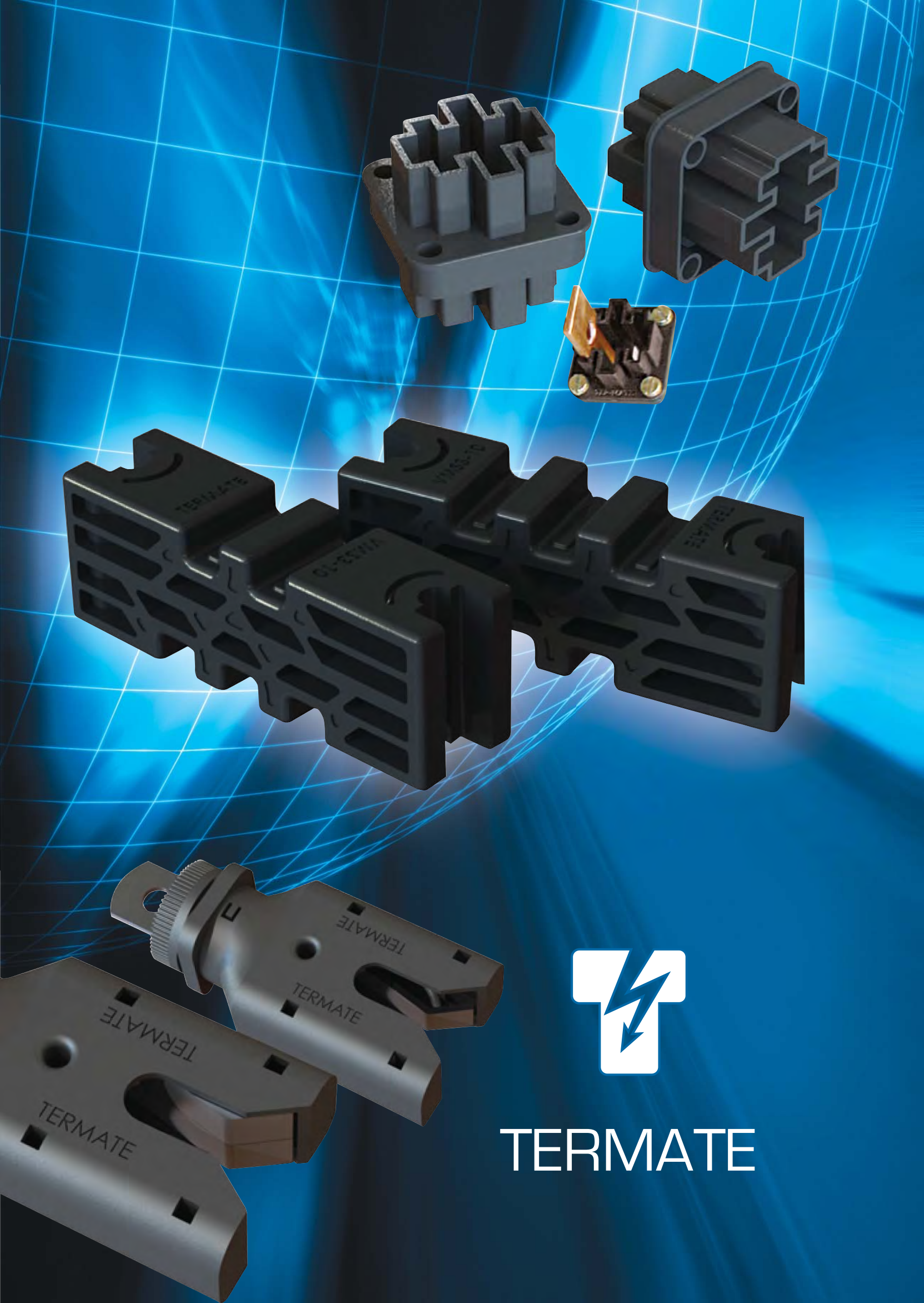

KOD	CİNSİ	AD. / \$	K. / AD.
XK2-35 / 10 x 4	125 A, Giriş 35 mm <sup>2</sup> - Çıkış : 4 x 10 mm <sup>2</sup>	13,23 \$	20
XK2-35 / 4 x 9	125 A, Giriş 35 mm <sup>2</sup> - Çıkış : 9 x 4 mm <sup>2</sup>	14,28 \$	20
XK2-35 x 2 / 16 x 4	125 A, Giriş 2 x 35mm <sup>2</sup> - Çıkış : 4x 16 mm <sup>2</sup>	Ⓢ	12
XK2-50 / 10 x 6	150 A, Giriş 50 mm <sup>2</sup> - Çıkış : 6 x 10 mm <sup>2</sup>	16,80 \$	12
XK2-50 / 16 x 4	150 A, Giriş 50 mm <sup>2</sup> - Çıkış : 4 x 16 mm <sup>2</sup>	16,80 \$	12
XK2-70 / 6 x 12	192 A, Giriş 70 mm <sup>2</sup> - Çıkış : 12 x 6 mm <sup>2</sup>	23,22 \$	10
XK2-70 / 10 x 8	192 A, Giriş 70 mm <sup>2</sup> - Çıkış : 8 x 10 mm <sup>2</sup>	20,88 \$	10
XK2-70 x 2 / 10 x 8	192 A, Giriş 2 x 70 mm <sup>2</sup> - Çıkış : 8 x 10 mm <sup>2</sup>	25,00 \$	10
XK2-70 / 16 x 6	192 A, Giriş 70 mm <sup>2</sup> - Çıkış : 6 x 16 mm <sup>2</sup>	21,00 \$	10
XK2-95 / 25 x 4	232A, Giriş 95 mm <sup>2</sup> - Çıkış : 4 x 25 mm <sup>2</sup>	25,00 \$	10
XK2-120 / 16 x 8	232 A, Giriş 120 mm <sup>2</sup> - Çıkış : 8 x 16 mm <sup>2</sup>	Ⓢ	10
XK2-120B / 16 x 8	(Köprülenebilir) 232 A, Giriş 120 mm <sup>2</sup> - Çıkış : 8 x 16 mm <sup>2</sup>	Ⓢ	10
XK2-185/35 x 8	353 A, Giriş 185 mm <sup>2</sup> - Çıkış : 8 x 35 mm <sup>2</sup>	Ⓢ	10
XK2-185B / 35 x 8	(Köprülenebilir) 353 A, Giriş 185 mm <sup>2</sup> - Çıkış : 8 x 35 mm <sup>2</sup>	Ⓢ	10
XK2-185 x 2 / 35 x 8	353 A, Giriş 2 x 185 mm <sup>2</sup> - Çıkış : 8 x 35 mm <sup>2</sup>	Ⓢ	10
XK2-300 / 50 x 6	630 A, Giriş 300 mm <sup>2</sup> - Çıkış : 6 x 50 mm <sup>2</sup>	Ⓢ	10
XK2S-25 / 10 x 2 + 4 x 2	100 A, 25 mm <sup>2</sup> Düz pin, Çıkış : 2 x 4 mm <sup>2</sup> , 2 x 10 mm <sup>2</sup>	7,85 \$	40
XK2S-35 / 10 x 2 + 4 x 2	125 A, 35 mm <sup>2</sup> M6 delikli pin, Çıkış : 2 x 4 mm <sup>2</sup> , 2 x 10 mm <sup>2</sup>	7,85 \$	40
XK2S-25 / 4 x 9	100 A, 25 mm <sup>2</sup> Düz pin, Çıkış : 9 x 4 mm <sup>2</sup>	9,00 \$	40
XK2S-35 / 4 x 9	125 A, 35 mm <sup>2</sup> M6 delikli pin, Çıkış : 9 x 4 mm <sup>2</sup>	9,00 \$	40
XK2S-70 / 16 x 4	192 A, 70 mm <sup>2</sup> M8 delikli pin, Çıkış : 4 x 16 mm <sup>2</sup>	10,71 \$	25
XK2S-70 / 10 x 6	192 A, 70 mm <sup>2</sup> M8 delikli pin, Çıkış : 6 x 10 mm <sup>2</sup>	Ⓢ	25
XK2S-95 / 6 x 12	232 A, 95 mm <sup>2</sup> M10 delikli pin, Çıkış : 12 x 6 mm <sup>2</sup>	Ⓢ	20
XK2S-95 / 10x8	232 A, 95 mm <sup>2</sup> M10 delikli pin, Çıkış : 8 x 10 mm <sup>2</sup>	Ⓢ	20
XK2S-95 / 16 x 6	232 A, 95mm <sup>2</sup> M10 delikli pin, Çıkış : 6 x 16 mm <sup>2</sup>	Ⓢ	20
XK2S-95 / 25 x 4	232 A, 95 mm <sup>2</sup> M10 delikli pin, Çıkış : 4 x 25 mm <sup>2</sup>	Ⓢ	20
XK2S-120 / 16 x 8	269 A, 120 mm <sup>2</sup> M12 delikli pin, Çıkış : 8 x 16 mm <sup>2</sup>	Ⓢ	15
XK2S-120 / 35 x 4	269 A, 120 mm <sup>2</sup> M12 delikli pin, Çıkış : 4 x 35 mm <sup>2</sup>	Ⓢ	15



TERMATE

Materyal	Cam Elyaf, Polyemid 66
İletken Sıcaklığı	140 °C
Yanıcılık	UL94-V0
Glow Wire	960 °C
Equipment Voltage $U_e$	1000 V
Insulation Voltage $U_i$	1000 V
Impulse Voltage $U_{imp}$	12 kV
Icw Ratings	65 kA/3 sec
Icw Ratings	50 kA/1 sec

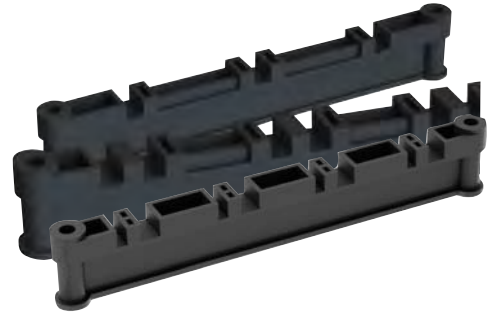
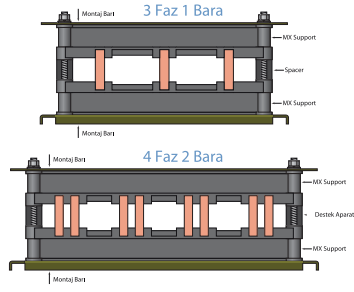

## GELENEKSEL TARAK İZOLATÖRLER

KOD	AÇIKLAMA	AD. / €
TERM-MXM11013NS	10 mm, 3'lü Bara İçin Tarak İzolatör (Faz Arası 110 mm)	11.60 €
TERM-MXM11023NS	10 mm, 2 x 3'lü Bara İçin Tarak İzolatör (Faz Arası 110 mm)	11.60 €
TERM-MX68224NS	5 mm, 2 x 4'lü Bara İçin Tarak İzolatör (Faz Arası 82 mm)	11.60 €
TERM-MXHM7014NS	10 mm, 4'lü Bara İçin Tarak İzolatör (Faz Arası 70 mm)	11.60 €
TERM-MX618224NS	7 mm, 2 x 4'lü Bara İçin Tarak İzolatör (Faz Arası 82 mm)	11.60 €
TERM-MXB6514NS	6,35 mm, 4'lü Bara İçin Tarak İzolatör (Faz Arası 65 mm)	10.08 €
TERM-MX16514NS	6 mm, 4'lü Bara İçin Tarak İzolatör (Faz Arası 65 mm)	10.08 €
TERM-MXM6014NS	6,35 mm, 4'lü Bara İçin Tarak İzolatör (Faz Arası 60 mm)	10.08 €
TERM-MXM6524NS	10 mm, 2 x 4'lü Bara İçin Tarak İzolatör (Faz Arası 65 mm)	10.08 €
TERM-MXMI8214NS	10 mm, 4'lü Bara İçin Tarak İzolatör (Faz Arası 82 mm)	11.60 €
TERM-MXB6014NS	6,35 mm, 4'lü Bara İçin Tarak İzolatör (Faz Arası 60 mm)	10.52 €
TERM-MXB6524NS	6,35 mm, 2 x 4'lü Bara İçin Tarak İzolatör (Faz Arası 65 mm)	8.88 €
TERM-MXM6514	10 mm, 4'lü Bara İçin Tarak İzolatör (Faz Arası 65 mm)	8.44 €
TERM-MXM6514NS	10 mm, 4'lü Bara İçin Tarak İzolatör (Faz Arası 65 mm)	8.44 €
TERM-MXM8213	10 mm, 3'lü Bara İçin Tarak İzolatör	8.68 €
TERM-MXM8213NS	10 mm, 3'lü Bara İçin Tarak İzolatör	8.68 €
TERM-MXM8214	10 mm, 4'lü Bara İçin Tarak İzolatör (Faz Arası 82 mm)	11.56 €
TERM-MXM8214NS	10 mm, 4'lü Bara İçin Tarak İzolatör (Faz Arası 82 mm)	11.56 €
TERM-MXM8223	10 mm, 2 x 3'lü Bara İçin Tarak İzolatör (Faz Arası 82 mm)	10.04 €
TERM-MXM8223NS	10 mm, 2 x 3'lü Bara İçin Tarak İzolatör (Faz Arası 82 mm)	10.04 €
TERM-MXM8224	10 mm, 2 x 4'lü Bara İçin Tarak İzolatör (Faz Arası 82 mm)	8.88 €
TERM-MXM8224NS	10 mm, 2 x 4'lü Bara İçin Tarak İzolatör (Faz Arası 82 mm)	8.88 €
TERM-MXM605-10	10 mm ve 5 mm Baralar İçin Tarak İzolatör Alternatifleri	

## YÜKSELTİCİ ARA APARATLAR, GELENEKSEL TARAK İZOLATÖRLER İÇİN

KOD	AÇIKLAMA	AD. / €
TERM-MXS12	12 mm Siyah MX Destekleyici Ara Aparat	0.72 €
TERM-MXS15	15 mm Siyah MX Destekleyici Ara Aparat	0.80 €
TERM-MXS25	25 mm Siyah MX Destekleyici Ara Aparat	0.84 €
TERM-MXS27	27 mm Siyah MX Destekleyici Ara Aparat	0.88 €
TERM-MXS5	5 mm Siyah MX Destekleyici Ara Aparat	0.64 €
TERM-MXS7	7 mm Siyah MX Destekleyici Ara Aparat	0.68 €



## ÇOK AMAÇLI İZOLATÖRLER

KOD	AÇIKLAMA	AD. / €
TERM-VMS3-10	10 mm, 3'lü İkili Bara İçin Çok Amaçlı İzolatör	9.44 €
TERM-VMS3-S110	Ara Aparat, Fazlar Arası Mesafe 110 mm	1.52 €
TERM-VMS3-S130	Ara Aparat, Fazlar Arası Mesafe 130 mm	2.52 €

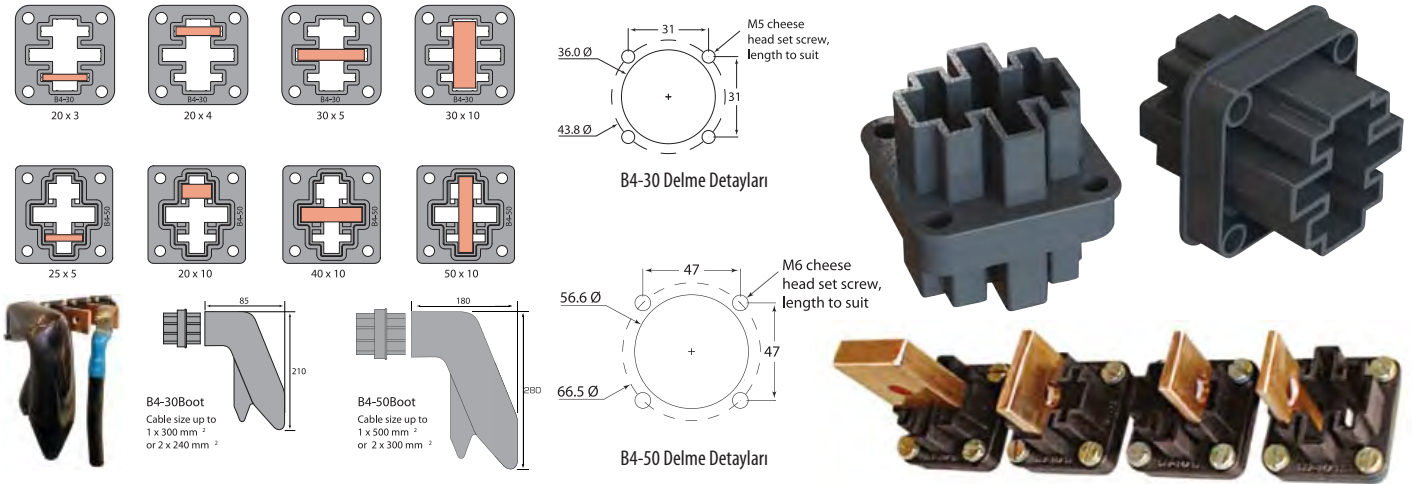

## PANODAN PANOYA GEÇİŞ İZOLATÖRLERİ

KOD	AÇIKLAMA	AD. / €
TERM-B4-30	Geçiş İzolatörü 20 x 3, 20 x 4, 30 x 5, 30 x 10	2.20 €
TERM-B4-50	Geçiş İzolatörü 25 x 5, 20 x 10, 40 x 10, 50 x 10	4.72 €
TERM-B4-30BOOT	Silikon Kılıf	14.00 €
TERM-B4-50BOOT	Silikon Kılıf	16.00 €

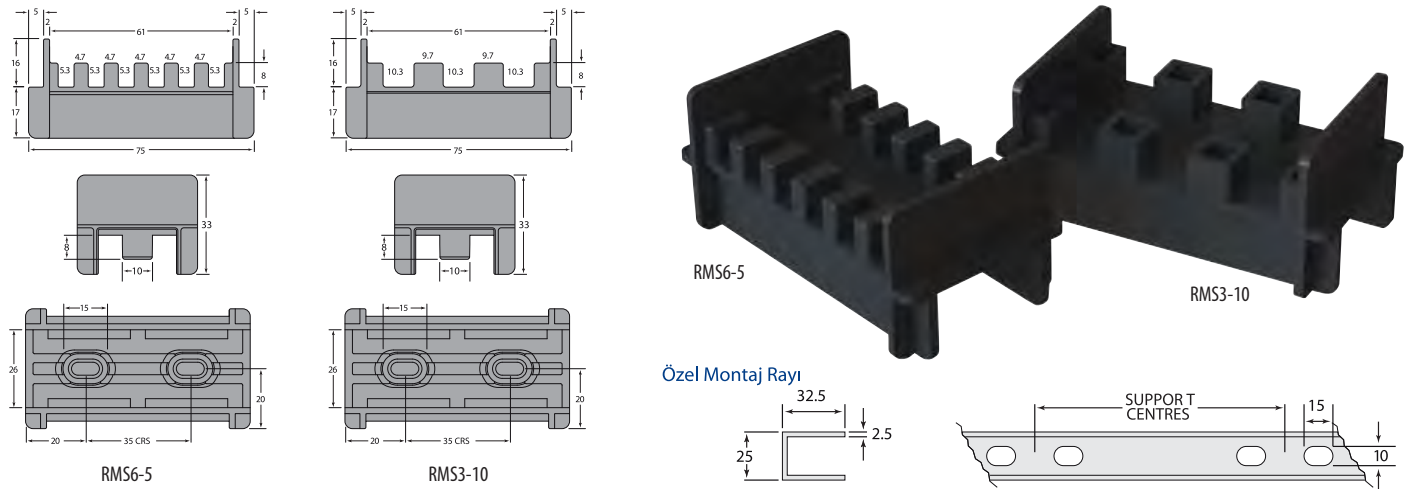

## ÖZEL RAYA TAKILAN İZOLATÖRLER



KOD	AÇIKLAMA	AD. / €
TERM-RMS3-10	10 mm, 3'lü Bara İçin İzolatör	2.68 €
TERM-RMS6-5	5 mm, 6'lı Bara İçin İzolatör	2.84 €

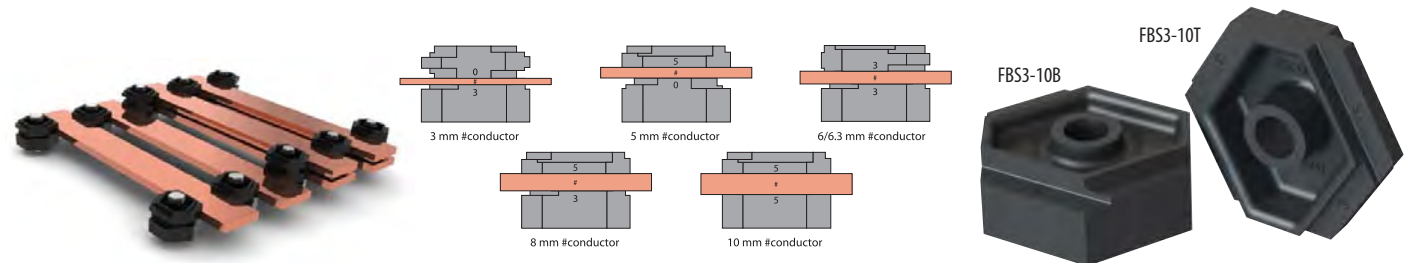

## ALTIGEN İZOLATÖR

KOD	AÇIKLAMA	AD. / €
TERM-FBS3-10T	Altigen İzolatör (Yukarı Desteği)	4.25 €
TERM-FBS3-10B	Altigen İzolatör (Alt Desteği)	4.25 €

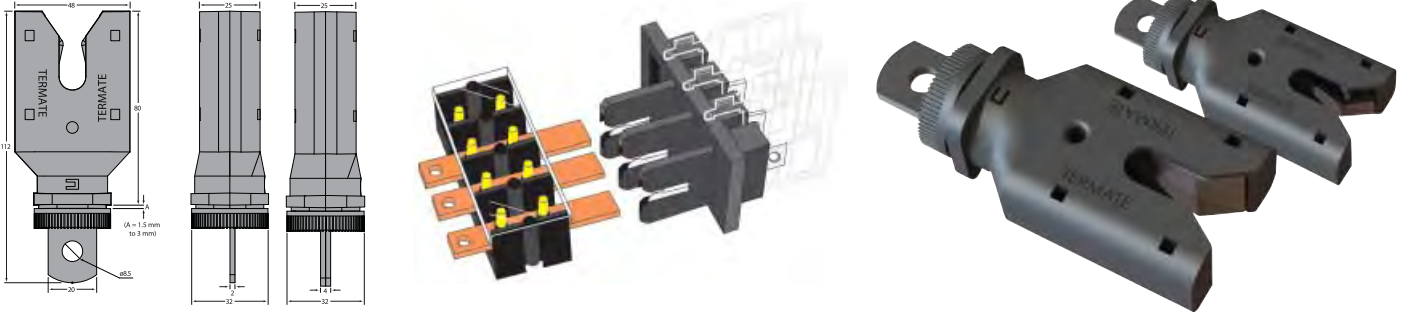

### ÇEKMECELİ TİP PANOLARDA KULLANILAN BARALAR İÇİN FİŞ KONNEKTÖR

KOD	AÇIKLAMA	AD. / €
TERM-BPSP250-6	Çekmeceli Tip Panolarda Kullanılan 250 A, 6 ve 5 mm Bara İçin Fiş Konnektör	27.92 €
TERM-BPSP250-10	Çekmeceli Tip Panolarda Kullanılan 250 A, 10 mm Bara İçin Fiş Konnektör	30.64 €
TERM-BPSP400-6	Çekmeceli Tip Panolarda Kullanılan 400 A, 6 ve 5 mm Bara İçin Fiş Konnektör	36.32 €
TERM-BPSP400-10	Çekmeceli Tip Panolarda Kullanılan 400 A, 10 mm Bara İçin Fiş Konnektör	45.24 €

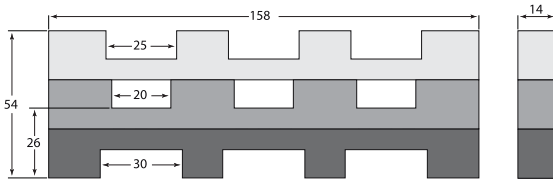
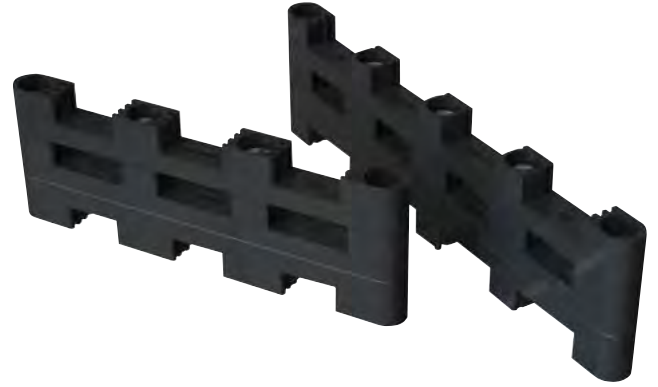
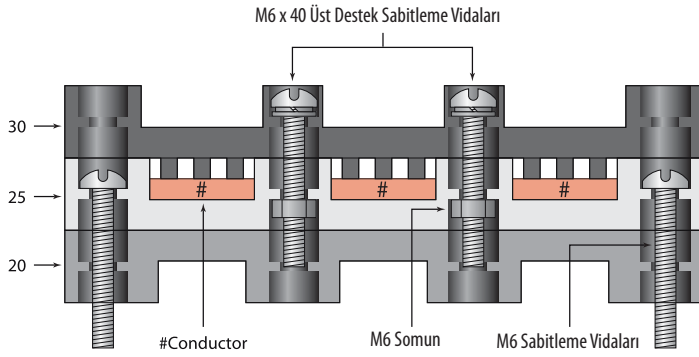

DBBS-3P

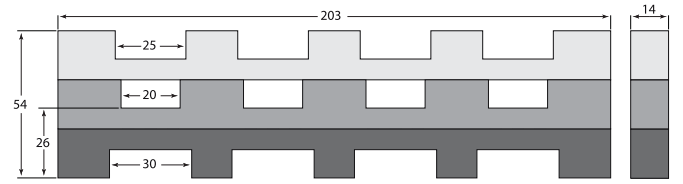
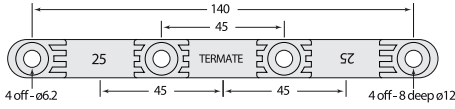

DBBS-4P

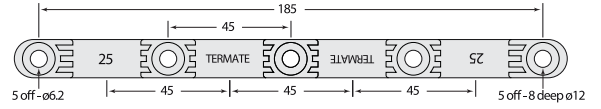

### 3 KATLI SET İZOLATÖRLER

KOD	AÇIKLAMA	AD. / €
TERM-DBBS-3P	3 Faz, 30 x 10, 25 x 10, 20 x 10, 25 x 5 ve 20 x 5 mm Bara İçin Yassı Set İzolatör	11.56 €
TERM-DBBS-4P	4 Faz, 30 x 10, 25 x 10, 20 x 10, 25 x 5 ve 20 x 5 mm Bara İçin Yassı Set İzolatör	13.60 €



TERMATE

### MESNET İZOLATÖRLER (DİŞİDEN DİŞİYE)

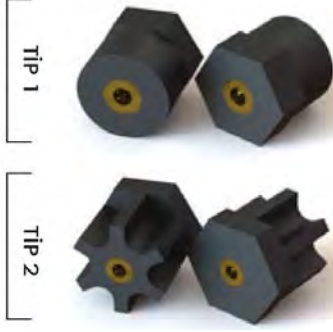
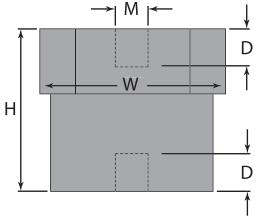

KOD	TİP	YÜK. (H) (mm)	GEN. (W) (mm)	VİDA Ç. (M)	UZUN. (L) (mm)	MAX TORK (Nm)	AD. / €
TERM-C2X625F	1	25	25	M6	7	7	5.13 €
TERM-C2X630F	1	30	25	M6	7	7	5.38 €
TERM-C2X830F	1	30	25	M8	9	17	5.85 €
TERM-C2X635F	1	35	25	M6	7	7	5.64 €
TERM-C2X835F	1	35	25	M8	10	17	6.00 €
TERM-C3X635F	2	35	35	M6	7	7	6.51 €
TERM-C3X835F	2	35	35	M8	9	17	6.67 €
TERM-C3X1035F	2	35	35	M10	10	33	7.13 €
TERM-C3X640F	2	40	35	M6	7	7	6.67 €
TERM-C3X840F	2	40	35	M8	9	17	6.92 €
TERM-C3X1040F	2	40	35	M10	10	33	7.33 €
TERM-C3X645F	2	45	35	M6	7	7	6.92 €
TERM-C3X845F	2	45	35	M8	9	17	7.13 €
TERM-C3X1045F	2	45	35	M10	10	33	7.54 €
TERM-C3X650F	2	50	35	M6	7	7	7.13 €
TERM-C3X850F	2	50	35	M8	9	17	7.33 €
TERM-C3X1050F	2	50	35	M10	10	33	7.74 €

### MESNET İZOLATÖRLER (DİŞİDEN ERKEĞE)

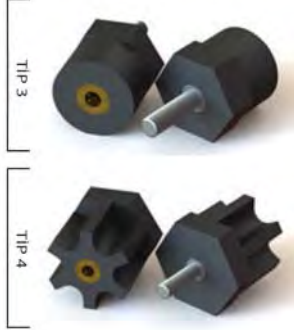
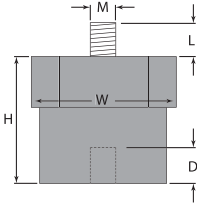

KOD	TİP	YÜK. (H) (mm)	GEN. (W) (mm)	VİDA ÇAPI (M)	DERİNL. (D) (mm)	UZUNL. (L) (mm)	MAX. TORK (Nm)	AD. / €
TERM-C2X625H	3	25	25	M6	7	20	7	5.02 €
TERM-C2X825H	3	25	25	M8	9	20	14	5.38 €
TERM-C2X630H	3	30	25	M6	7	20	7	5.33 €
TERM-C2X830H	3	30	25	M8	9	20	14	6.00 €
TERM-C2X635H	3	35	25	M6	7	20	7	5.49 €
TERM-C2X835H	3	35	25	M8	9	20	14	6.20 €
TERM-C3X635H	4	35	35	M6	7	20	7	6.15 €
TERM-C3X835H	4	35	35	M8	9	20	14	6.87 €
TERM-C3X1035H	4	35	35	M10	10	34	30	8.05 €
TERM-C3X640H	4	40	35	M6	7	20	7	6.62 €
TERM-C3X840H	4	40	35	M8	9	20	14	7.08 €
TERM-C3X1040H	4	40	35	M10	10	34	30	8.20 €
TERM-C3X645H	4	45	35	M6	7	20	7	6.82 €
TERM-C3X845H	4	45	35	M8	9	20	14	7.28 €
TERM-C3X1045H	4	45	35	M10	10	34	30	8.46 €

### MESNET İZOLATÖRLER (ERKEKTEN ERKEĞE)

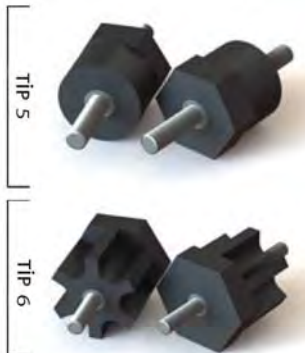
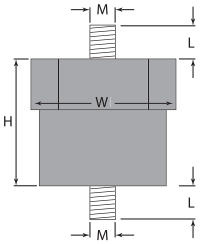

KOD	TİP	YÜK. (H) (mm)	GENİŞLİK (W) (mm)	VİDA ÇAPI (M)	UZUN. (L) (mm)	MAX. TORK (Nm)	AD. / €
TERM-C2X625M	5	25	25	M6	20	7	4.87 €
TERM-C2X630M	5	30	25	M6	20	7	5.23 €
TERM-C2X830M	5	30	25	M8	20	14	6.20 €
TERM-C2X635M	5	35	25	M6	20	7	5.44 €
TERM-C2X835M	5	35	25	M8	20	14	6.36 €
TERM-C3X635M	6	35	35	M6	20	7	6.66 €
TERM-C3X835M	6	35	35	M8	20	14	7.03 €
TERM-C3X1035M	6	35	35	M10	34	30	8.92 €
TERM-C3X640M	6	40	35	M6	20	7	6.56 €
TERM-C3X840M	6	40	35	M8	20	14	7.28 €
TERM-C3X1040M	6	40	35	M10	34	30	9.13 €
TERM-C3X645M	6	45	35	M6	20	7	6.72 €
TERM-C3X845M	6	45	35	M8	20	14	7.44 €
TERM-C3X1045M	6	45	35	M10	34	30	9.38 €
TERM-C3X650M	6	50	35	M6	20	7	6.97 €
TERM-C3X850M	6	50	35	M8	20	14	7.59 €
TERM-C3X1050M	6	50	35	M10	34	30	9.59 €

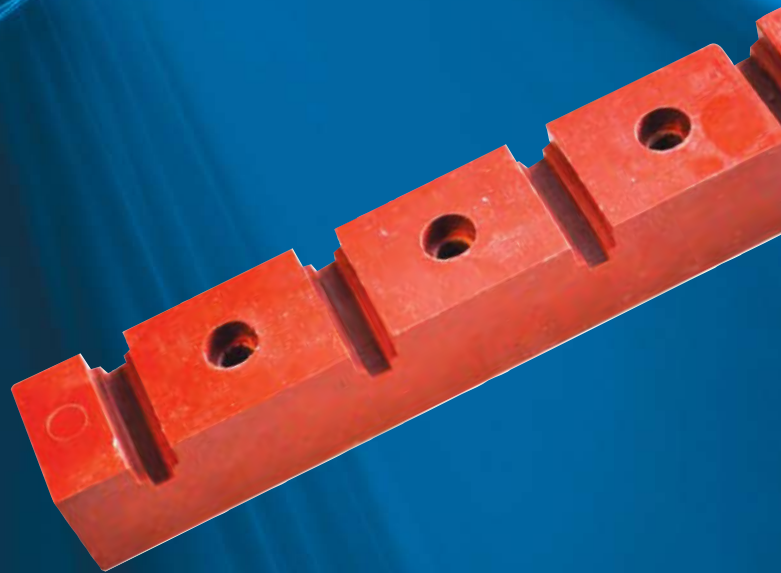

## A.G. MESNET İZALATÖRLERİ (Cam Elyaf Polyester İzolatörler) FIÇI MODEL

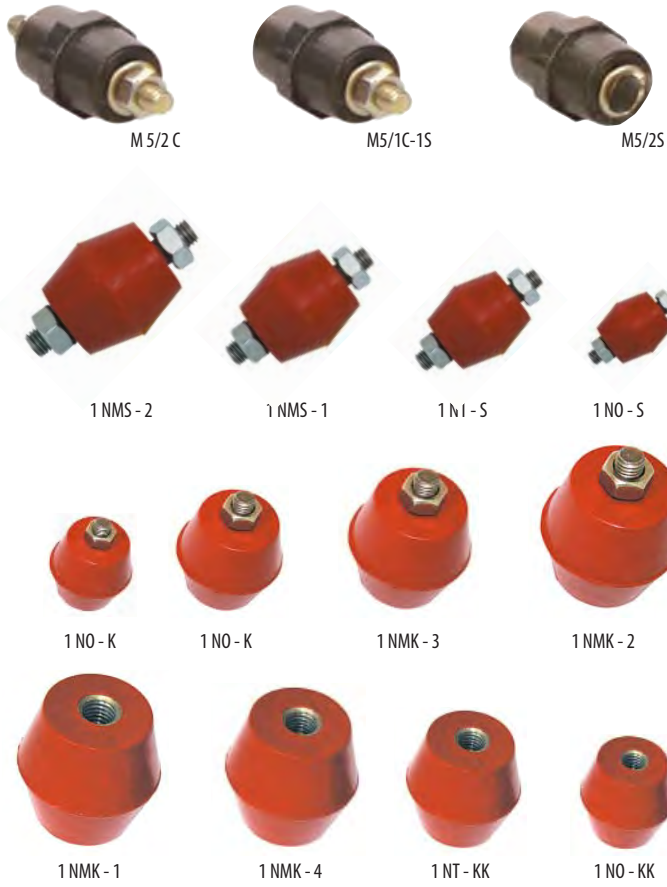

KOD	CİNSİ	FİYAT / ₺	K./AD.
EMTİ- M 5/2 C	M5 Mini Saplamalı İzolatör	0.66	100
EMTİ- M5/1C-1S	M5 Mini Saplamalı + Kör somunlu İzolatör	0.88	100
EMTİ- M5/2S	M5 Mini Kör somunlu İzolatör	1.10	100
EMTİ-1N0-S	M5 ÇİFT TARAF SAPLAMALI	0.76	500
EMTİ-1N1-S	M6 ÇİFT TARAF SAPLAMALI	1.15	300
EMTİ-1NMS-1	M8 ÇİFT TARAF SAPLAMALI	1.85	100
EMTİ-1NMS-2	M10 ÇİFT TARAF SAPLAMALI	1.90	100
EMTİ-1N0-K	M5 SAPLAMALI & KÖRSOMUNLU	0.89	500
EMTİ-1N0-K	M6 SAPLAMALI & KÖRSOMUNLU	1.30	300
EMTİ-1NMK-3	M8 SAPLAMALI & KÖRSOMUNLU	2.25	100
EMTİ-1NMK-2	M10 SAPLAMALI & KÖRSOMUNLU	2.30	100
EMTİ-1N0-KK	M5 ÇİFT TARAF KÖRSOMUNLU	1.20	500
EMTİ-1N1-KK	M6 ÇİFT TARAF KÖRSOMUNLU	1.60	300
EMTİ-1NMK-4	M8 ÇİFT TARAF KÖRSOMUNLU	2.25	100
EMTİ-1NMK-1	M10 ÇİFT TARAF KÖRSOMUNLU	2.30	100

## A.G. MESNET İZALATÖRLERİ (Cam Elyaf Polyester) KONİK MODEL



KOD	CİNSİ	FİYAT / ₺	K./AD.
EMTİ- M6/2 C	M6 Mini Boy Konik Saplamalı İzolatör	1.10	50
EMTİ- M6/1 C+1S	M6 Mini Boy Konik Saplamalı+Kör somunlu İzolatör	1.35	50
EMTİ- M6/2 S	M6 Mini Boy Konik Körsomunlu İzolatör	1.50	50
EMTİ- M6/2 C	M6 Orta Boy Konik Saplamalı İzolatör	1.26	50
EMTİ-M6/1 C+1S	M6 Orta Boy Konik Saplamalı + Kör somunlu İzolatör	1.50	50
EMTİ- M6/2S	M6 Orta Boy Konik Körsomunlu İzolatör	1.68	50

## A.G. MESNET İZALATÖRLERİ (Cam Elyaf Polyester)



KOD	CİNSİ	FİYAT / ₺	K./AD.
EMTİ-1NMD-1	M16 Kör Somunlu	7.45	18
EMTİ-1NMA-2	M12 - 16 Kör Somunlu Konik	7.40	18
EMTİ-1NMC-3	M16 Kör Somunlu	6.90	18
EMTİ-1N500	M10 - 12 Kör Somunlu	6.75	32
EMTİ-1N1000	Mesnet İzalatörü Kör Somunlu	⊕	10



**PLASTİK MESNET İZOLATÖRLERİ (P46 Cam Elyaf V01, Alev İletmez)**



KOD	CİNSİ	FİYAT / ₺	K./AD.
EMTİ-1 NO-S (P)	M5 ÇİFT TARAF SAPLAMALI	0.99	500
EMTİ-1N1-S (P)	M6 ÇİFT TARAF SAPLAMALI	1.63	300
EMTİ-1NMS-1 (P)	M8 ÇİFT TARAF SAPLAMALI	2.40	100
EMTİ-1NMS-2 (P)	M10 ÇİFT TARAF SAPLAMALI	2.50	100
EMTİ- NO-K (P)	M5 SAPLAMALI & KÖR SOMUNLU	1.16	500
EMTİ-1N1-K(P)	M6 SAPLAMALI & KÖR SOMUNLU	1.69	300
EMTİ-1NMK-3 (P)	M8 SAPLAMALI & KÖR SOMUNLU	2.93	100
EMTİ-1NMK-2(P)	M10 SAPLAMALI & KÖR SOMUNLU	2.99	100
EMTİ-1NO-KK (P)	M5 ÇİFT TARAF KÖR SOMUNLU	1.56	500
EMTİ-1N1-KK (P)	M6 ÇİFT TARAF KÖR SOMUNLU	2.13	300
EMTİ-1NMK-4 (P)	M8 ÇİFT TARAF KÖR SOMUNLU	2.93	100
EMTİ-1NMK-1(P)	M10 ÇİFT TARAF KÖR SOMUNLU	2.99	100

**BARA TUTUCU SERFİLLER**



KOD	CİNSİ	FİYAT / ₺	K./AD.
EMTİ - M8-M10	SERFİL	2.25	100
EMTİ - M16	SERFİL	2.50	100
EMTİ - ÖS	10 x 120 ÖZ. SER	17.50	100

**A.G. TARAK İZOLATÖRLERİ**

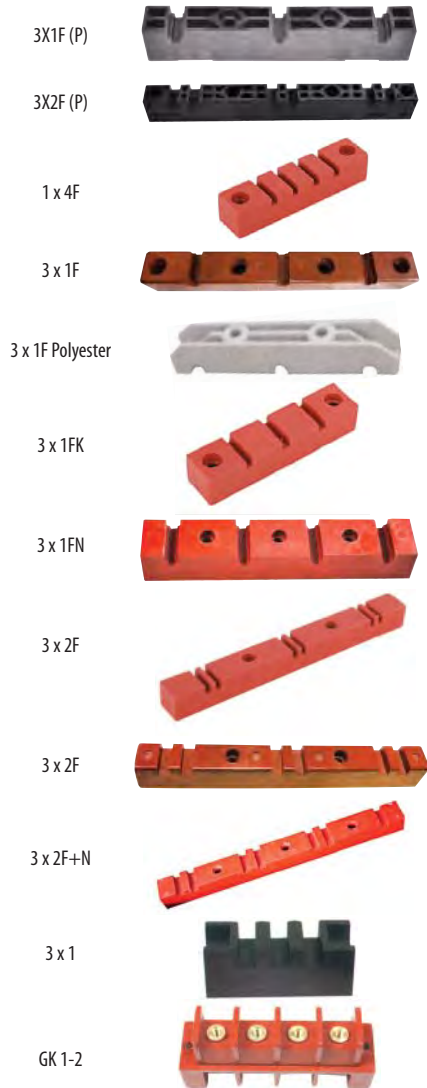

KOD	CİNSİ	FİYAT / ₺	K./AD.
EMTİ- 3X1F (P) Plastik	5-10 mm Bara için Plastik (Adet)	6.40	30 Ad.
EMTİ- 3X2F (P) Plastik	10 mm Bara için Plastik (Adet)	9.10	50 Ad.
EMTİ-1 x 4 F	Tarak İzol. 10 mm Bara L:134 mm Polyaster	5.15	25 Tk.
EMTİ-3 x 1F	Tarak İzol. 5-10 mm Bara L:196 mm	5.85	15 Tk.
EMTİ-3 x 1F (Polyester)	Polyester Tarak İzol. 5-10 mm Bara L:196mm	11.00	15 Tk.
EMTİ-3 x 1FK	Tarak İzol. 5 mm Bara için L:134 mm	5.15	25 Tk.
EMTİ-3 x 1F+N	Tarak İzol. 5 mm Bara için L:134 mm	5.15	25 Tk.
EMTİ-3x1F+N=230	Tarak İzol. 5-10 mm Bara için L: 230 mm	8.30	16 Tk.
EMTİ-3 x 2 F	Tarak İzol. 5 mm Bara için L:285 mm	7.20	25 Tk.
EMTİ-3 x 2 F	Tarak İzol. 10 mm Bara için L:285 mm	7.20	25 Tk.
EMTİ-3 x 2F+N	Tarak İzol. Nötür 10mm Bara L:380	11.50	25 Tk.
EMTİ- 3 x 3F	Tarak İzolatörü 10 mm Bara L:440 mm	36.80	15 Tk.
EMTİ- 3X1	Tarak İzolatörü 10 mm Bara L:10 mm	Ⓢ	16 Tk.
EMTİ - GK 1	10 cm Boy 100 A M6 Geçiş İzolatörü	Ⓢ	1 AD.
EMTİ-GK2	200 A M12 Geçiş İzolatörü	Ⓢ	1 AD.

## 400 V GÜÇ KONDANSATÖRLERİ (TÜP)

KOD	AÇIKLAMA	KvAR / €	K. AD.
RTR-T0.5KvAR 400	Güç Kond. 400V	Ⓞ	10
RTR-T1 KvAR 400	Güç Kond. 400V		10
RTR-T1.5KvAR 400	Güç Kond. 400V		10
RTR-T2.5KvAR 400	Güç Kond. 400V		10
RTR-T5KvAR 400	Güç Kond. 400V		6
RTR-T7.5KvAR 400	Güç Kond. 400V		6
RTR-T10KvAR1 400	Güç Kond. 400V		6
RTR-T12.5KvAR 400	Güç Kond. 400V		6
RTR-T15KvAR 400	Güç Kond. 400V		6
RTR-T20KvAR 400	Güç Kond. 400V		6
RTR-T25KvAR 400	Güç Kond. 400V		4
RTR-T30KvAR 400	Güç Kond. 400V		4
RTR-T35KvAR 400	Güç Kond. 400V		4
RTR-T40KvAR 400	Güç Kond. 400V		4



## 440 V GÜÇ KONDANSATÖRLERİ (TÜP)

KOD	AÇIKLAMA	KvAR / €	K. AD.
RTR-T0.5KvAR 440	Güç Kond. 440V	Ⓞ	10
RTR-T1 KvAR 440	Güç Kond. 440V		10
RTR-T2.5KvAR 440	Güç Kond. 440V		10
RTR-T5KvAR 440	Güç Kond. 440V		10
RTR-T7.5KvAR 440	Güç Kond. 440V		6
RTR-T10KvAR1 440	Güç Kond. 440V		6
RTR-T12.5KvAR 440	Güç Kond. 440V		6
RTR-T15KvAR 440	Güç Kond. 440V		6
RTR-T20KvAR 440	Güç Kond. 440V		6
RTR-T25KvAR 440	Güç Kond. 440V		6
RTR-T30KvAR 440	Güç Kond. 440V		4
RTR-T35KvAR 440	Güç Kond. 440V		4
RTR-T40KvAR 440	Güç Kond. 440V		4
RTR-T50KvAR 440	Güç Kond. 440V		4

## 230 V MONOFAZE GÜÇ KONDANSATÖRLERİ (TÜP)

KOD	AÇIKLAMA	KvAR / €	K. AD.
RTR-T0.83KvAR	Güç Kond. 230V	Ⓞ	9
RTR-T1.67KvAR	Güç Kond. 230V		9
RTR-T2.5KvAR	Güç Kond. 230V		9

## 400 V MONOFAZE GÜÇ KONDANSATÖRLERİ (TÜP)

KOD	AÇIKLAMA	KvAR / €	K. AD.
RTR-T0.50KvAR	Güç Kond. 400V	Ⓞ	9
RTR-T0.83KvAR	Güç Kond. 400V		9
RTR-T1.67KvAR	Güç Kond. 400V		9
RTR-T2.5KvAR	Güç Kond. 400V		9
RTR-T3.33KvAR	Güç Kond. 400V		9
RTR-T4.17KvAR	Güç Kond. 400V		9



# BRADY®

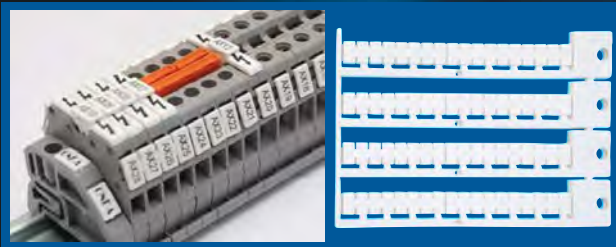

## BMP-71 YAZICI

KOD	AD. / €
BRAD-BMP-71 YAZICI	1.325 €



Not: Labelmark 5 Programında lisans tek bilgisayar içindir. Ekstra lisans bedeli 20.00 € 'dur.

## TLS2200 RİBONLARI



KOD	RENK	AD. / €
BRAD-R-4310	Siyah	36.67 €
BRAD-R-6210	Siyah	36.67 €
BRAD-R-6010	Siyah	36.67 €
BRAD-R-4410-W	Beyaz	41.67 €
BRAD-R-4410-R	Kırmızı	41.67 €
BRAD-R-4410-B	Mavi	41.67 €
BRAD-R-4410-G	Yeşil	41.67 €

Tüm ribonlar 22.9 mt uzunluktadır.

## BMP71 RİBONLARI



KOD	RENK	AD. / €
BRAD-M71-R4300	Siyah	66.67 €
BRAD-M71-R6000	Siyah	66.67 €
BRAD-M71-R6200	Siyah	66.67 €
BRAD-M71-R4400-WT	Beyaz	66.67 €
BRAD-M71-R6900-BL	Mavi	84.12 €
BRAD-M71-R6900-GN	Yeşil	84.12 €
BRAD-M71-R6900-RD	Kırmızı	84.12 €

Tüm ribonlar 46 mt uzunluktadır.

\*\* Renkli ribonlar, sadece siyah ribon olarak R-60.. kullanılan malzemelere baskı yapabilir.

## BUTON ETİKETLERİ

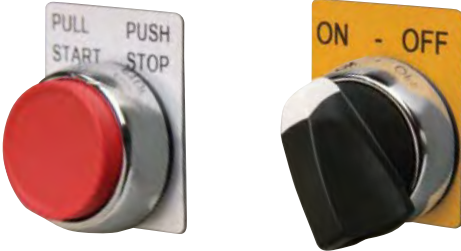

KOD	RENK	BİRİM. / €	K. / AD.
BRAD-M71EP-5-7593-SL	Gümüş	0.871 €	100
BRAD-M71EP-5-7593-WT	Beyaz	0.871 €	100
BRAD-M71EP-5-7593-BK	Siyah	1.417 €	100
BRAD-M71EP-5-7593-RD	Kırmızı	1.417 €	100
BRAD-M71EP-5-7593-GN	Yeşil	1.417 €	100
BRAD-M71EP-5-7593-YL	Sarı	1.417 €	100

BUTON ETİKETLERİ: 650 micron kalınlığında. En: 30mm Yükseklik: 40mm. 24 mm buton delikli. R-60.. ribonu kullanılır.

## PANO İÇİ KOMPONENT / ÜRÜN ETİKETLERİ



KOD	EN (mm)	YÜK. (mm)	RENK	BİRİM. / €	K. / AD.
BRAD-M71-41-499-YL	16	5	sarı	0.094 €	750
BRAD-M71-67-499-YL	15	9	sarı	0.118 €	750
BRAD-TLS-B499-45X9 (*)	15	9	sarı	0.075 €	1500
BRAD-TLS-B499-34X9 (*)	17	9	sarı	0.107 €	1000
BRAD-TLS-B499-18x8 (*)	18	8	sarı	0.076 €	1500
BRAD-TLS-B499-20x8 (*)	20	8	sarı	0.096 €	1500
BRAD-PTL-47-499-YL	20	8	sarı	0.146 €	750
BRAD-PTL-44-422	12.7	9.52	beyaz	0.101 €	500
BRAD-PTL-44-430	12.7	9.52	şeffaf	0.094 €	500
BRAD-M71C-375-422	9.53	15 mt	Beyaz Bant	5.111 €	Sürekli
BRAD-M71C-475-422	12.07	15 mt	Beyaz Bant	4.013 €	Sürekli

(\*) İşaretili 499 kodlu malzemeler için R-43..., diğer 499 etiketler için R-62..., 430 kodlu malzemeler için R-60.. önerilir.

(\*) Bu ürünlerde 1 sırada birden fazla etiket vardır. Klavye kullanılarak değil, Labelmark ile baskı yapılabilir.

## KALIN PANO ETİKETLERİ



KOD	EN (mm)	YÜK. (mm)	RENK	BİRİM. / €	K. / AD.
BRAD-M71EP-1-7593-WT	27	8	Beyaz	0.284 €	250
BRAD-M71EP-1-7593-SL	27	8	Gümüş	0.350 €	250
BRAD-PTLEP-01-7593-RD	27	8	Kırmızı	0.421 €	250
BRAD-PTLEP-01-7593-YL	27	8	Sarı	0.255 €	250
BRAD-PTLEP-01-7593-BK	27	8	Siyah	0.289 €	250
BRAD-PTLEP-01-7593-GR	27	8	Yeşil	0.255 €	250
BRAD-M71EP-2-7593-WT	27	12.5	Beyaz	0.372 €	250
BRAD-M71EP-2-7593-SL	27	12.5	Gümüş	0.372 €	250
BRAD-PTLEP-02-7593-RD	27	12.5	Kırmızı	0.372 €	250
BRAD-PTLEP-02-7593-YL	27	12.5	Sarı	0.372 €	250
BRAD-PTLEP-02-7593-BK	27	12.5	Siyah	0.533 €	250
BRAD-PTLEP-02-7593-GR	27	12.5	Yeşil	0.372 €	250
BRAD-M71EP-3-7593-WT	27	15	Beyaz	0.474 €	150
BRAD-M71EP-3-7593-SL	27	15	Gümüş	0.474 €	150
BRAD-PTLEP-03-7593-RD	27	15	Kırmızı	0.427 €	150
BRAD-PTLEP-03-7593-YL	27	15	Sarı	0.427 €	150
BRAD-PTLEP-03-7593-BK	27	15	Siyah	0.484 €	150
BRAD-M71EP-4-7593-WT	27	18	Beyaz	0.543 €	150
BRAD-M71EP-4-7593-SL	27	18	Gümüş	0.543 €	150
BRAD-PTLEP-04-7593-YL	27	18	Sarı	0.488 €	150
BRAD-PTLEP-04-7593-BK	27	18	Siyah	0.553 €	150
BRAD-PTLEP-04-7593-GR	27	18	Yeşil	0.488 €	150
BRAD-M71EP-7-7593-WT	35	18	Beyaz	0.755 €	100
BRAD-M71EP-7-7593-SL	35	18	Gümüş	1.070 €	100
BRAD-M71EP-7-7593-YL	35	18	Sarı	1.070 €	100
BRAD-PTLEP-07-7593-BK	35	18	Siyah	1.070 €	100
BRAD-BM71E-6-7593-SL	45	15	Gümüş	0.527 €	500
BRAD-BM71E-6-7593-WT	45	15	Beyaz	0.527 €	500
BRAD-M71EP-6-7593-BK	45	15	Kırmızı	0.961 €	100
BRAD-M71EP-6-7593-RD	45	15	Siyah	0.961 €	100
BRAD-M71EP-6-7593-YL	45	15	Sarı	0.961 €	100
BRAD-M71EP-8-7593-WT	48	19	Beyaz	1.231 €	125
BRAD-M71EP-8-7593-SL	48	19	Gümüş	1.231 €	125
BRAD-PTLEP-08-7593-YL	48	19	Sarı	1.255 €	125
BRAD-PTLEP-08-7593-BK	48	19	Siyah	1.255 €	125
BRAD-PTLEP-09-7593-WT	25	75	Beyaz	2.905 €	100
BRAD-PTLEP-09-7593-YL	25	75	Sarı	2.905 €	100
BRAD-PTLEP-10-7593-WT	25	100	Beyaz	3.325 €	100
BRAD-PTLEP-10-7593-YL	25	100	Sarı	3.325 €	100
BRAD-PTLEP-174-7593-SV	25	101	Gümüş	2.933 €	50

650 micron kalınlığında pano etiketleri. R-60.. ribon önerilir. Bir ribon ile etiket boyuna bağlı olmak üzere takribi 2,000 etikete kadar basılabilir.

## KLEMENS ETİKETİ (OPK VE MRK SERİSİ İÇİN)



KOD	EN (mm)	BİRİM (m) / €	K. / AD.
BRAD-TLS-B7696-11MMX10METER-UNPRTD (B7696)	11	7.33 €	10 mt

10 metre uzunluğunda, 11 mm yüksekliğindedir. ONKA, MRK ve OPK klemensler için kullanılmaktadır. Klemensin üzerine takılan dekafix şeklindeki taşıyıcının üzerine monte edilebilir. Rengi Parlak beyazdır. R-60.. veya R-43.. önerilir.

**KLEMENS ETİKETİ: KLEMSAN (PYK SERİSİ)**

KOD	EN (mm)	BİRİM (m) / €	K. / AD.
BRAD-TLS-B7596 - 16,2 mm x 15 mt	16,2 ve 5	4.67 €	15 m

15 metre uzunluğunda 2 farklı klemens için tasarlanmış bant vardır. İster ikisini, isterseniz sadece birini kullanabilirsiniz. Yanyana dizilmiş klemenslerin enine göre bilgisayarda uzun bant olarak tasarlanıp basılıp, tırnakların arasına itirilerek takılır. R-62.. kullanılır.

**KLEMENS ETİKETİ: PHOENIX**

KOD	EN (mm)	KUTU / €	K. / AD.
BRAD-TLS-B7696-46,3 mm x 6.2mm	46.2	0.0198 €	6750

Her etiket 46.2 mm uzunluğunda, 6,2 mm yüksekliğinde olup yan yana dizilmiş klemenslerin enine göre bilgisayarda tasarlanıp basılıp tırnakların arasına itilerek takılır. Fazlası kesilir, uzun sıralarda yan yana birden fazla etiket kullanılır. Rengi parlak beyazdır. R-60.. veya R-43.. önerilir.

**KLEMENS ETİKETİ (TIRNAKSIZ MODELLER İÇİN)**

KOD	EN (mm)	KUTU / €	K. / AD.
BRAD-PTLTB-5-7551	4.5	2.57	15
BRAD-PTLTB-8-7551	8	4.28	15
BRAD-BM71C-240-498	6.10	6.10	83.80
BRAD-M71C-240-498	6.10	8.05	9.14
BRAD-BM71C-318-498	8.08	5.33	83.8
BRAD-M71C-318-498	8.08	7.07	9.1
BRAD-BM71C-375-498	9.53	5.41	83.8
BRAD-M71C-375-498	9.53	7.14	9.14

Bantlar, kullanılan klemenslerin eni kadar küçük parçalar olarak tanımlanıp, kaç adet klemens varsa tek parça olarak basılıp yapıştırılır. Son derece dayanıklıdır. Düşmez. Aradan klemens değişikliği yapmak gerekirse kaldırılıp tekrar yapıştırılabilir. R-62.. önerilir.  
(\* Klemens eninin 5 mm olduğu varsayımıyla)

**DİREKT KABLOYA GEÇİRİLEN ETİKETLER**

KOD	EN (mm)	YÜK. (mm)	KABLO KESİTİ (mm <sup>2</sup> )	BİRİM. / €	K. / AD.
BRAD-BM71R-1-7599-YL	5.2	23	0.25-0.75	0.095 €	2500
BRAD-BM71R-2-7599-YL	5.2	23	0.75-1.5	0.095 €	2500
BRAD-BM71R-3-7599-YL	5.7	25	1.5-2.5	0.104 €	2500
BRAD-BM71R-4-7599-YL	5.2	23	2,5-6,0	0.108 €	2500
BRAD-BM71R-5-7599-YL	5.7	25	4,2-16	0.141 €	2500

2 deliğinden kabloya geçirilen, kolay kullanımlı, çok ekonomik etiketler. Sadece sarı renk mevcuttur. R-60.. veya R-43.. önerilir.

**MONTAJDAN SONRA TAKILABİLEN KİLİTLİ SİSTEM PLASTİK TAŞIYICILAR**

KOD	EN (mm)	YÜK. (mm)	KABLO KESİTİ (mm <sup>2</sup> )	BİRİM. / €	K. / AD.
BRAD-CLC-1-L23	5.2	23	0.50 - 1.5	0.101 €	1000
BRAD-CLC-2-L23	5.2	23	0.75 - 2.5	0.101 €	1000
BRAD-CLC-3-L23	5.7	23	2.5 - 6	0.106 €	1000
BRAD-CLC-4-L23	5.2	23	10 - 35	0.106 €	1000
BRAD-CLC-5-L23	5.7	23	25 - 70	0.110 €	1000

## PLASTİK TAŞIYICI İÇENE KONAN KABLO ETİKETLERİ



R-43.. ribon önerilir.

KOD	EN (mm)	YÜK. (mm)	ÖZELLİK	BİRİM. / €	K. / AD.
BRAD-PTDSU-10-7597	10	4.2	katlanan beyaz	0.080 €	1500
BRAD-PTDSU-10-7597-YL	10	4.2	Katlanan sarı	0.075 €	1500
BRAD-PTDSU-15-7597	15	4.2	katlanan beyaz	0.059 €	1500
BRAD-PTDSU-15-7597-YL	15	4.2	Katlanan sarı	0.082 €	1500
BRAD-PTDSU-30-7597	30	4.2	katlanan beyaz	0.065 €	1500
BRAD-PTDSU-30-7597-YL	30	4.2	Katlanan sarı	0.101 €	1500
BRAD-BM71D-1-7696	10	4.4	Beyaz	0.073 €	2500
BRAD-BM71D-1-7696-YL	10	4.4	Sarı	0.073 €	2500
BRAD-BM71D-2-7696	12	4.4	Beyaz	0.073 €	2500
BRAD-BM71D-2-7696	12	4.4	Sarı	0.073 €	2500
BRAD-BM71D-3-7696	16	4.4	Beyaz	0.074 €	2500
BRAD-BM71D-3-7696-YL	16	4.4	Sarı	0.074 €	5000
BRAD-BM71D-4-7696	23	4.4	Beyaz	0.073 €	2500
BRAD-BM71D-4-7696-YL	23	4.4	Sarı	0.073 €	2500
BRAD-BM71D-5-7696	30	4.4	Beyaz	0.074 €	2500
BRAD-BM71D-5-7696-YL	30	4.4	Sarı	0.074 €	5000

## PLASTİK TAŞIYICILAR



KOD	EN (mm)	KABLO ÇAPI (mm)	KABLO KESİTİ (mm <sup>2</sup> )	BİRİM. / €	K. / AD.
BRAD-AC-0-L10	10	1.3 - 2.0	0.22 - 0.5	0.018 €	2000
BRAD-AC-0-L16	16	1.3 - 2.0	0.22 - 0.5	0.022 €	2000
BRAD-AC-0-L23	23	1.3 - 2.0	0.22 - 0.5	0.032 €	2000
BRAD-AC-0-L30	30	1.3 - 2.0	0.22 - 0.5	0.048 €	1000
BRAD-AC-1-L10	10	1.8 - 2.5	0.50 - 1.5	0.018 €	2000
BRAD-AC-1-L16	16	1.8 - 2.5	0.50 - 1.5	0.022 €	2000
BRAD-AC-1-L23	23	1.8 - 2.5	0.50 - 1.5	0.028 €	2000
BRAD-AC-1-L30	30	1.8 - 2.5	0.50 - 1.5	0.072 €	1000
BRAD-AC-2-L10	10	2.5 - 4.0	0.75 - 2.5	0.018 €	2000
BRAD-AC-2-L16	16	2.5 - 4.0	0.75 - 2.5	0.024 €	2000
BRAD-AC-2-L23	23	2.5 - 4.0	0.75 - 2.5	0.034 €	2000
BRAD-AC-2-L30	30	2.5 - 4.0	0.75 - 2.5	0.051 €	1000
BRAD-AC-3-L10	10	4.5 - 6.5	2.5 - 6	0.028 €	1000
BRAD-AC-3-L16	16	4.5 - 6.5	2.5 - 6	0.030 €	1000
BRAD-AC-3-L23	23	4.5 - 6.5	2.5 - 6	0.040 €	1000
BRAD-AC-3-L30	30	4.5 - 6.5	2.5 - 6	0.060 €	1000
BRAD-AC-4-L10	10	6.0 - 10	10 - 35	0.032 €	1000
BRAD-AC-4-L16	16	6.0 - 10	10 - 35	0.034 €	1000
BRAD-AC-4-L23	23	4.5 - 6.5	10 - 35	0.050 €	1000
BRAD-AC-4-L30	30	6.0 - 10	10 - 35	0.077 €	500
BRAD-AC-5-L10	10	9.0 - 15.0	25 - 70	0.056 €	1000
BRAD-AC-5-L16	16	9.0 - 15.0	25 - 70	0.062 €	750
BRAD-AC-5-L23	23	9.0 - 15.0	25 - 70	0.084 €	500
BRAD-AC-5-L30	30	9.0 - 15.0	25 - 70	0.121 €	500
BRAD-AC-6-L10	10	15.0 - 24.0	35 - 120	0.081 €	500
BRAD-AC-6-L16	16	15.0 - 24.0	35 - 120	0.086 €	500
BRAD-AC-6-L23	23	15.0 - 24.0	35 - 120	0.121 €	500
BRAD-AC-6-L30	30	15.0 - 24.0	35 - 120	0.181 €	200

## ŞERİT MAKARONLAR (BEYAZ. SADECE BMP71 İLE KULLANILIR. 15,24 METRE.)

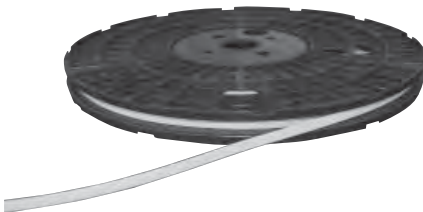

KOD	YASSI ŞEKLİYLE EN (mm)	MİN. MAX. KABLO ÇAPI (mm)	BİRİM (m) / €
BRAD-BM71C-125-342	5.96	1.17-2.79	12.239 €
BRAD-BM71C-187-342	8.50	1.57-3.81	13.953 €
BRAD-BM71C-250-342	11.15	2.39-5.46	16.548 €
BRAD-BM71C-375-342	16.38	3.18-8.13	24.371 €
BRAD-BM71C-500-342	21.61	4.75-11.43	28.174 €
BRAD-BM71C-1000-342	42.16	11.43-24.13	36.990 €

## KABLO ÜSTÜNE SARILAN ETİKETLER (BEYAZ RENK)



Yazılı kısım üzerine şeffaf tabakanın sarıldığı etiketler, R-43.. ribon önerilir.

KOD	YAZILACAK KISIM		MAX. KABLO ÇAPI (mm)	BİRİM. / €	K. / AD.
	EN (mm)	YÜK. (mm)			
BRAD-BM71-11-427	12.70	9.53	4.10mm	0.046 €	5000
BRAD-M71-11-427	12.70	9.53	4.10mm	0.108 €	500
BRAD-BM71-17-427	12.70	9.53	5.30mm	0.080 €	5000
BRAD-M71-17-427	12.70	9.53	5.30mm	0.115 €	500
BRAD-BM71-18-427	19.05	9.53	5.30mm	0.131 €	2500
BRAD-M71-18-427	19.05	9.53	5.30mm	0.187 €	250
BRAD-BM71-19-427	25.40	9.53	5.30mm	0.111 €	2500
BRAD-M71-19-427	25.40	9.53	5.30mm	0.206 €	250
BRAD-M71-28-427	6.35	12.70	6.64mm	0.086 €	750
BRAD-BM71-29-427	12.70	12.70	6.64mm	0.098 €	5000
BRAD-M71-29-427	12.70	12.70	6.64mm	0.140 €	500
BRAD-BM71-30-427	19.05	12.70	6.64mm	0.147 €	2500
BRAD-M71-30-427	19.05	12.70	6.64mm	0.210 €	250
BRAD-BM71-31-427	25.40	12.70	6.64mm	0.111 €	2500
BRAD-M71-31-427	25.40	12.70	6.64mm	0.266 €	250
BRAD-BM71-32-427	38.10	12.70	6.64mm	0.190 €	1000
BRAD-M71-32-427	38.10	12.70	6.64mm	0.272 €	250
BRAD-BM71-21-427	25.40	19.05	11.06mm	0.255 €	1000
BRAD-M71-21-427	25.40	19.05	11.06mm	0.396 €	100
BRAD-BM71-23-427	25.40	25.40	17.71mm	0.330 €	1000
BRAD-M71-23-427	25.40	25.40	17.71mm	0.471 €	100
BRAD-BM71-33-427	38.10	25.40	17.71mm	0.392 €	500
BRAD-M71-33-427	38.10	25.40	17.71mm	0.638 €	100
BRAD-BM71-34-427	38.10	38.10	26.56mm	0.510 €	500
BRAD-M71-34-427	38.10	38.10	26.56mm	1.057 €	50

## KABLO ÜSTÜNE SARILAN ETİKETLER (SARI RENK)



KOD	YAZILACAK KISIM		MAX. KABLO ÇAPI (mm)	BİRİM. / €	K. / AD.
	EN (mm)	YÜK. (mm)			
BRAD-PTL-11-427-YL	12.70	9.53	4.10mm	0.140 €	500
BRAD-PTL-17-427-YL	12.70	9.53	5.30mm	0.149 €	500
BRAD-PTL-18-427-YL	19.05	9.53	5.30mm	0.244 €	250
BRAD-M71-19-427-YL	25.40	9.53	5.30mm	0.265 €	250
BRAD-PTL-29-427-YL	12.70	12.70	6.64mm	0.183 €	500
BRAD-PTL-30-427-YL	19.05	12.70	6.64mm	0.273 €	250
BRAD-M71-31-427-YL	25.40	12.70	6.64mm	0.332 €	250
BRAD-M71-32-427-YL	38.10	12.70	6.64mm	0.341 €	250
BRAD-M71-21-427-YL	25.40	19.05	11.06mm	0.494 €	100
BRAD-PTL-23-427-YL	25.40	25.40	17.71mm	0.613 €	100
BRAD-M71-33-427-YL	38.10	25.40	17.71mm	0.798 €	100
BRAD-PTL-34-427-YL	38.10	38.10	26.56mm	1.375 €	50



## ISI İLE DARALAN MAKARONLAR / BEYAZ



3/1 oranında daralır. R-43.. ribon önerilir. Beyaz ve sarı rengi mevcuttur.. Daha küçük en gerekirse, rahatlıkla makasla kesmek mümkündür (ikiye bölmek,üçe bölmek)

KOD	YAZILACAK KISIM		MAX. KABLO ÇAPI (mm)	BİRİM / €	K. / AD.
	EN (mm)	YÜK. (mm)			
BRAD-BM71-94-1-342	25.78	4.62	0.58-2.03	0.329 €	2500
BRAD-M71-94-1-342	25.78	4.62	0.58-2.03	0.759 €	100
BRAD-BM71-94-1-342-2	12.89	4.62	0.58-2.03	0.181 €	5000
BRAD-BM71-94-175-342-2	22.41	4.62	0.58-2.03	0.243 €	5000
BRAD-M71-94-175-342	44.83	4.62	0.58-2.03	0.986 €	100
BRAD-BM71-94-175-342	44.83	4.62	0.58-2.03	0.442 €	2500
BRAD-BM71-125-1-342-2	12.89	5.97	1.17-2.79	0.190 €	2000
BRAD-BM71-125-175-342-3	14.94	5.97	1.17-2.79	0.170 €	3000
BRAD-BM71-125-175-342-2	22.41	5.97	1.17-2.79	0.255 €	2000
BRAD-BM71-125-1-342	25.78	5.97	1.17-2.79	0.345 €	1000
BRAD-M71-125-1-342	25.78	5.97	1.17-2.79	0.784 €	100
BRAD-M71-125-175-342	44.83	5.97	1.17-2.79	1.019 €	100
BRAD-BM71-125-175-342	44.83	5.97	1.17-2.79	0.464 €	1000
BRAD-BM71-187-175-342-4	11.21	8.51	1.57-3.81	0.142 €	4000
BRAD-BM71-187-1-342-2	12.89	8.51	1.57-3.81	0.212 €	2000
BRAD-BM71-187-175-342-3	14.94	8.51	1.57-3.81	0.190 €	3000
BRAD-BM71-187-175-342-2	22.41	8.51	1.57-3.81	0.284 €	2000
BRAD-BM71-187-1-342	25.78	8.51	1.57-3.81	0.386 €	1000
BRAD-M71-187-1-342	25.78	8.51	1.57-3.81	0.799 €	100
BRAD-M71-187-175-342	44.83	8.51	1.57-3.81	1.039 €	100
BRAD-BM71-187-175-342	44.84	8.51	1.57-3.81	0.517 €	1000
BRAD-BM71-250-1-342	25.78	11.15	2.39-5.46	0.467 €	1000
BRAD-M71-250-1-342	25.78	11.15	2.39-5.46	0.905 €	100
BRAD-M71-250-175-342	44.83	11.15	2.39-5.46	1.178 €	100
BRAD-BM71-250-175-342	44.83	11.15	2.39-5.46	0.627 €	1000
BRAD-BM71-375-1-342-2	12.89	16.38	3.18-8.13	0.378 €	2000
BRAD-BM71-375-175-342-2	22.41	16.38	3.18-8.13	0.508 €	2000
BRAD-BM71-375-1-342	25.78	16.38	3.18-8.13	0.687 €	1000
BRAD-M71-375-1-342	25.78	16.38	3.18-8.13	0.982 €	100
BRAD-M71-375-175-342	44.83	16.38	3.18-8.13	1.276 €	100
BRAD-BM71-375-175-342	44.83	16.38	3.18-8.13	0.924 €	1000
BRAD-BM71-500-1-342	25.78	21.62	4.75-11.43	0.794 €	1000
BRAD-M71-500-1-342	25.78	21.62	4.75-11.43	1.135 €	100
BRAD-M71-500-175-342	44.83	21.62	4.75-11.43	1.475 €	100
BRAD-BM71-500-175-342	44.83	21.62	4.75-11.43	1.069 €	1000
BRAD-M71-1000-175-342	44.83	42.16	11.43-24.13	2.541 €	50
BRAD-BM71-1000-175-342	44.83	42.16	11.43-24.13	1.485 €	500
BRAD-M71-1000-1-342	25.78	42.16	11.43-24.13	1.955 €	50

## ISI İLE DARALAN MAKARONLAR / BEYAZ



3/1 oranında daralır. R-43.. ribon önerilir. Beyaz ve sarı rengi mevcuttur.. Daha küçük en gerekirse, rahatlıkla makasla kesmek mümkündür (ikiye bölmek,üçe bölmek)

BRAD-M71-94-1-342YL	25.78	4.62	0.58-2.03	0.759 €	100
BRAD-BM71-94-1-342YL	25.78	4.62	0.58-2.03	0.329 €	2500
BRAD-M71-94-175-342YL	44.83	4.62	0.58-2.03	0.986 €	100
BRAD-BM71-94-175-342YL	44.83	4.62	0.58-2.03	0.443 €	2500
BRAD-BM71-125-1-342-YL	25.78	5.97	1.17-2.79	0.345 €	1000
BRAD-M71-125-1-342YL	25.78	5.97	1.17-2.79	0.784 €	100
BRAD-M71-125-175-342YL	44.83	5.97	1.17-2.79	1.019 €	100
BRAD-BM71-125-175-342YL	44.83	5.97	1.17-2.79	0.464 €	1000
BRAD-BM71-187-1-342YL	25.78	8.51	1.57-3.81	0.385 €	1000
BRAD-M71-187-1-342YL	25.78	8.51	1.57-3.81	0.799 €	100
BRAD-M71-187-175-342YL	44.83	8.51	1.57-3.81	1.039 €	100
BRAD-BM71-187-175-342YL	44.83	8.51	1.57-3.81	0.517 €	1000
BRAD-BM71-250-1-342-YL	25.78	11.15	2.39-5.46	0.467 €	1000
BRAD-M71-250-1-342YL	25.78	11.15	2.39-5.46	0.905 €	100
BRAD-M71-250-175-342YL	44.83	11.15	2.39-5.46	1.178 €	100
BRAD-BM71-250-175-342YL	44.83	11.15	2.39-5.46	0.627 €	1000
BRAD-BM71-375-1-342-YL	25.78	16.38	3.18-8.13	0.687 €	1000
BRAD-M71-375-1-342YL	25.78	16.38	3.18-8.13	0.982 €	100
BRAD-M71-375-175-342YL	44.83	16.38	3.18-8.13	1.276 €	100
BRAD-BM71-375-175-342-YL	44.83	16.38	3.18-8.13	0.924 €	1000
BRAD-BM71-500-1-342YL-3	14.94	21.62	4.75-11.43	0.291 €	3000
BRAD-BM71-500-1-342YL	25.78	21.62	4.75-11.43	0.794 €	1000
BRAD-M71-500-1-342YL	25.78	21.62	4.75-11.43	1.152 €	100
BRAD-M71-500-175-342YL	44.83	21.62	4.75-11.43	1.475 €	100
BRAD-BM71-500-175-342YL	44.83	21.62	4.75-11.43	1.069 €	1000
BRAD-M71-1000-175-342YL	44.83	42.16	11.43-24.13	2.541 €	50
BRAD-M71-1000-1-342YL	25.78	42.16	11.43-24.13	1.955 €	50

## KABLO BAĞI İLE BAĞLANAN ETİKETLER

## 2 KABLO BAĞIYLA BAĞLANAN



KOD	EN (mm)	YÜKSEKLİK (mm)	ÖNERİLEN İÇ ETİKET	BİRİM. / €	K. / AD.
BRAD-LC-71 x 9-B7644	9	71	5	0.621 €	100
BRAD-LC-65 x 13-B7644	13	65	5	0.850 €	100
BRAD-LC-103 x 15-B7644	15	103	6	0.642 €	100
BRAD-LC-128 x 15-B7644	15	128	1, 7, 8	0.856 €	100
BRAD-LC-178 x 15-B7644	15	178	2, 7, 8	1.926 €	50

## 1 KABLO BAĞIYLA BAĞLANAN

KOD	EN (mm)	YÜKSEKLİK (mm)	ÖNERİLEN İÇ ETİKET	BİRİM. / €	K. / AD.
BRAD-LT-59x25-B7645	59	25	4	1.070 €	50
BRAD-LT-150x25-B7645	150	25	3	2.140 €	50
BRAD-LT-800x400-B7644	80	40	9	1.417 €	100

## 1 KABLO BAĞIYLA BAĞLANAN (METAL HALKALI)

KOD	EN (mm)	YÜKSEKLİK (mm)	ÖNERİLEN İÇ ETİKET	BİRİM. / €	K. / AD.
BRAD-LT-59x25-B7645-WR	59	25	4	2.105 €	50
BRAD-LT-150x25-B7645-WR	150	25	3	3.228 €	50

2 katlı olup, yazının altta belirtilen etiketlere yazılıp, etiketin aşağıda belirtilen taşıyıcıların üstüne yapıştırıldıktan sonra yazılı kısmın üstüne şeffaf koruyucu kaplanan tip etiketler. Sadece sarı renk mevcuttur.

## İÇ ETİKETLER



KOD	EN (mm)	YÜKSEKLİK (mm)	ÖZELLİK	BİRİM. / €	K. / AD.
BRAD-PTLTL-1-430	11	74	Şeffaf	0.981 €	100
BRAD-PTLTL-2-430	11	124	Şeffaf	1.750 €	50
BRAD-PTLTL-3-430	21	129	Şeffaf	1.569 €	50
BRAD-PTLTL-4-430	37	21	Şeffaf	0.410 €	300
BRAD-PTLTL-5-430	39	5	Şeffaf	0.197 €	300
BRAD-TLS-B430-46X11	48	11	Şeffaf	0.146 €	500
BRAD-M71C-375-430	9.53	15 mt	Şeffaf	4.727 €	15 mt
BRAD-M71C-500-430	12.7	15 mt	Şeffaf	3.707 €	15 mt
BRAD-M71C-500-595-XX	12.7	15 mt	XX: renk kodu	4.499 €	15 mt
BRAD-M71C-1000-595-xx	25	15 mt	XX: renk kodu	5.873 €	15 mt

## 2- DİREKT ÜSTÜNE YAZILAN ETİKETLER



KOD	EN (mm)	YÜKSEKLİK (mm)	ÖZELLİK	BİRİM. / €	K. / AD.
BRAD-M71-12-109	19.05	76.20	Beyaz	0.532 €	100
BRAD-PTL-12-109-YL	19.05	76.20	Sarı	0.628 €	100
BRAD-BM71-12-109	19.05	76.20	Beyaz	0.373 €	1000
BRAD-M71-60-109	12.50	50.00	Beyaz	0.353 €	100
BRAD-BM71-60-109	12.50	50.00	Beyaz	0.247 €	1000
BRAD-M71-36-109	44.45	25.58	Beyaz	0.284 €	250
BRAD-BM71-111-145-GY	30.63	19.25	Gri	0.944 €	1000
BRAD-M71-111-145-FR-GY	30.63	19.25	Gri	1.387 €	100
BRAD-M71-111-145-GY	30.63	19.25	Gri	1.156 €	100
BRAD-BM71-110-145-GY	44.45	25.40	Gri	0.944 €	1000
BRAD-M71-110-145-GY	44.45	25.40	Gri	1.388 €	100

Etiketin üstüne direkt yazıcı ile yazı yazılan etiketler. R-60.. ribon önerilir. 0,21 mm KALINLIKTAKİ MALZEMEDEN

## 0,45 mm KALINLIKTAKİ HALOJEN-FREE MALZEMEDEN



KOD	EN (mm)	YÜKSEKLİK (mm)	ÖZELLİK	BİRİM. / €	K. / AD.
BRAD-BM71H-1-7643-WT	10	60	Beyaz	3.068 €	250
BRAD-BM71H-1-7643-YL	10	60	Sarı	3.240 €	250
BRAD-BM71H-2-7643-WT	10	75	Beyaz	3.155 €	250
BRAD-BM71H-2-7643-YL	10	75	Sarı	3.155 €	250
BRAD-BM71H-3-7643-WT	25	75	Beyaz	3.695 €	250
BRAD-BM71H-3-7643-YL	25	75	Sarı	3.614 €	250

## UZUN BANTLAR



KOD	EN (mm)	ÖZELLİK	METRE / €	K. / AD.
BRAD-PTLTB-8-422	8	Beyaz parlak	3.756 €	15
BRAD-M71C-375-422	9.53	Beyaz parlak	5.111 €	15
BRAD-M71C-375-430	9.53	Şeffaf poly	4.727 €	15
BRAD-M71C-500-422	12.70	Beyaz parlak	4.013 €	15
BRAD-M71C-500-595-xx	12.7	Çeşitli renkler	4.499 €	15
BRAD-M71C-500-428	12.70	Gümüş	4.383 €	15
BRAD-M71C-1000-422	25.40	Beyaz parlak	7.048 €	15
BRAD-M71C-1000-430	25.40	Şeffaf poly	6.514 €	15
BRAD-M71C-1000-595-xx	25.40	Çeşitli renkler	5.421 €	15
BRAD-M71C-1000-483	25.40	Beyaz parlak	7.347 €	15
BRAD-M71C-1900-422	48.26	Beyaz parlak	10.570 €	15
BRAD-M71C-1900-430	48.26	Şeffaf poly	9.778 €	15
BRAD-PTL-43-435	48.26	Metal parlak	12.039 €	15
BRAD-M71C-2000-595-xx	50.80	Çeşitli renkler	5.492 €	15
BRAD-M71C-500-581-YL	12.70	Sarı	3.733 €	15
BRAD-M71C-500-581-WT	12.70	Beyaz	3.733 €	15
BRAD-M71C-1000-581-YL	25.40	Sarı	5.536 €	15
BRAD-M71C-1000-581-WT	25.40	Beyaz	5.536 €	15
BRAD-M71C-2000-581-YL	50.80	Sarı	7.337 €	15
BRAD-M71C-1000-581-WT	50.80	Beyaz	5.536 €	15
BRAD-BM71C-1000-582	25.40	Fotoluminesant	7.634 €	22.86
BRAD-BM71C-2000-582	50.80	Fotoluminesant	12.230 €	22.86
BRAD-BM71C-1000-584-OR	25.40	Reflektif turuncu	7.634 €	22.86
BRAD-BM71C-1000-584-WT	25.40	Reflektif sarı	7.634 €	22.86
BRAD-BM71C-1000-584-YL	25.40	Reflektif beyaz	7.634 €	22.86
BRAD-BM71C-2000-584-OR	50.80	Reflektif turuncu	12.230 €	22.86
BRAD-BM71C-2000-584-WT	50.80	Reflektif beyaz	12.230 €	22.86
BRAD-BM71C-2000-584-YL	50.80	Reflektif sarı	12.230 €	22.86

Uyarılar, sigorta etiketi, pano içine uzun etiket yapmak v.b. için R-60.. önerilir. xx Kodlu ürünlerin farklı renkleri mevcuttur.. xx Yerine renk kodu gelir. Kod boşsa: Beyaz, YL: Sarı, OR: Turuncu, BL: Mavi, BK: Siyah, GN: Yeşil, RD: Kırmızı v.b. bantlarda BMC71C ile başlayan kodlu ürünler sadece BMP71 ile kullanılır.

## GARANTİ / GÜVENLİK ETİKETLERİ



Etiketin açılmaması / sökülmemesi gereken uygulamalar için kullanılır. Etiketi yerinden çıkarıp, tekrar takmak mümkün 351 malzeme için R-62.. ribon önerilir. 352 malzeme için R-60.. ribon önerilir.

KOD	EN (mm)	YÜKSEKLİK (mm)	ÖZELLİK	BİRİM. / €	K. / AD.
BRAD-M71-17-352	25.40	12.70	Gümüş	0.166 €	500
BRAD-M71-17-351	25.40	12.70	Beyaz	0.144 €	500
BRAD-M71-20-352	50.80	25.40	Gümüş	0.502 €	100
BRAD-M71-20-351	50.80	25.40	Beyaz	0.438 €	100
BRAD-M71-31-352	38.10	25.40	Gümüş	0.261 €	250
BRAD-M71-31-351	38.10	25.40	Beyaz	0.228 €	250
BRAD-M71-37-352	48.26	76.20	Gümüş	0.703 €	100
BRAD-M71-37-351	48.26	76.20	Beyaz	0.613 €	100
BRAD-M71C-500-530	12.70	15 mt	Beyaz	5.407 €	15 mt
BRAD-M71C-1000-530	25.40	15 mt	Beyaz	9.010 €	15 mt
BRAD-M71C-2000-530	50.80	15 mt	Beyaz	13.646 €	15 mt

## BAYRAK ETİKETLER



KOD	EN (mm)	YÜKSEKLİK (mm)	ÖZELLİK	BİRİM / €	K. / AD.
BRAD-M71FP-1-425	30.00	10.00	P şeklinde	0.249 €	250
BRAD-M71FP-2-425	44.45	12.70	P şeklinde	0.462 €	250
BRAD-M71FT-1-425	30.00	10.00	T şeklinde	0.249 €	250

Gayet sağlam bir materyalden yapılmıştır ve özel bir uygulama ile kolaylıkla kabloya uygulanır. R-43.. ribon önerilir.

## GENEL AMAÇLI ETİKETLER



KOD	EN (mm)	YÜKS. (mm)	RENK	BİRİM / €	K. / AD.
BRAD-BM71-17-428	25.4	12.7	Gümüş, mat	0.111 €	5000
BRAD-M71-17-428	25.4	12.7	Gümüş, mat	0.158 €	500
BRAD-M71-17-483	25.4	12.7	Beyaz, parlak	0.137 €	500
BRAD-M71-17-486	25.4	12.7	Gri, mat	0.164 €	500
BRAD-M71-17-489	25.4	12.7	Beyaz, mat	0.140 €	500
BRAD-M71-19-423	25.4	25.4	Beyaz, parlak	0.172 €	250
BRAD-BM71-19-423	25.4	25.4	Beyaz, parlak	0.120 €	2500
BRAD-M71-19-483	25.4	25.4	Beyaz, parlak	0.194 €	250
BRAD-M71-29-483	38.1	12.7	Beyaz, parlak	0.153 €	500
BRAD-M71-29-486	38.1	12.7	Gri, mat	0.189 €	500
BRAD-M71-29-489	38.1	12.7	Beyaz, mat	0.156 €	500
BRAD-M71-30-483	38.1	19.05	Beyaz, parlak	0.273 €	250
BRAD-M71-30-486	38.1	19.05	Gri, mat	0.262 €	250
BRAD-PTL-30-489	38.1	19.05	Beyaz, mat	0.283 €	250
BRAD-M71-31-423	38.1	25.4	Beyaz, parlak	0.194 €	250
BRAD-M71-31-483	38.1	25.4	Beyaz, parlak	0.219 €	250
BRAD-M71-32-423	38.1	38.1	Beyaz, parlak	0.277 €	250
BRAD-M71-32-489	38.1	38.1	Beyaz, mat	0.319 €	250
BRAD-PTL-20-435	50.80	25.40	Gümüş, parlak	0.400 €	100
BRAD-M71-20-424	50.80	25.40	Beyaz, mat	0.266 €	100
BRAD-BM71-20-424	50.80	25.40	Beyaz, mat	0.186 €	1000
BRAD-M71-20-428	50.80	25.40	Gümüş, mat	0.483 €	100
BRAD-BM71-20-428	50.80	25.40	Gümüş, mat	0.338 €	1000
BRAD-M71-20-483	50.80	25.40	Beyaz, parlak	0.374 €	100
BRAD-M71-20-486	50.80	25.40	Gri, mat	0.502 €	100
BRAD-PTL-20-489	50.80	25.40	Beyaz, mat	0.410 €	100
BRAD-M71-22-423	76.20	25.40	Beyaz, parlak	0.376 €	100
BRAD-M71-22-428	76.20	25.40	Gümüş, mat	0.527 €	100
BRAD-M71-37-422	76.20	48.26	Beyaz, parlak	0.581 €	100
BRAD-M71-37-483	76.20	48.26	Beyaz, mat	0.570 €	100
BRAD-PTL-37-435	76.20	48.26	Gümüş, parlak	0.575 €	100
BRAD-M71-37-483	76.20	48.26	Beyaz, parlak	0.570 €	100
BRAD-M71-37-486	76.20	48.26	Gri, mat	0.724 €	100
BRAD-M71-37-423	76.20	48.26	Beyaz, parlak	0.490 €	100
BRAD-PTL-37-489	76.20	48.26	Beyaz, mat	0.592 €	100
BRAD-PTL-37-428	76.20	48.26	Gri, mat	0.714 €	100
BRAD-M71-38-423	101.60	48.26	Beyaz, parlak	0.611 €	100
BRAD-M71-38-428	101.60	48.26	Gri, mat	0.795 €	100
BRAD-PTL-38-435	101.60	48.26	Gümüş, parlak	1.106 €	100
BRAD-M71-38-483	101.60	48.26	Beyaz, parlak	0.683 €	100
BRAD-PTL-38-486	101.60	48.26	Gri, mat	0.834 €	100
BRAD-M71-38-489	101.60	48.26	Beyaz, mat	0.683 €	100

Farklı amaçlar için, çok farklı boylarda ve farklı Özelliklerde üretilmiştir. Aşağıda sadece bazı örnekler verilmiştir. İhtiyacınıza uyan tipi bulamıyorsanız lütfen sorun.

## HAZIR UYARI İŞARETLERİ

## RULO GÜVENLİK İŞARETLERİ - LAMİNE VE POLYESTER

- \* **Materyal** : Lamine ve Polyester
- \* **Rulo Başına İşaret Sayısı** : 250
- \* **Mevcut Ebatlar** : 25,50 ve 100 mm kenarlı üçgen işaretler
- \* **Mevcut Ebatlar** : 25,50 ve 100 mm çapında yuvarlak işaretler

## FİYATLAR

- Üçgen Kenar Uzunluğu 25mm Rulo : 41.50 €
- Üçgen Kenar Uzunluğu 50mm Rulo : 100.00 €
- Üçgen Kenar Uzunluğu 100mm Rulo : 200.00 €



Referans Kod	PIC 300	PIC 301	PIC 302	PIC 303	PIC 304	PIC 305	PIC 307	PIC 308	PIC 309	PIC 310
Size (mm) Δ 25	227325	227326	227327	800100	251955	227329	251951	251950	251957	227331
Δ 50	227353	227354	227355	800101	223315	227357	223307	223305	223319	227359
Δ 100	227300	227301	227302	800102	223316	227304	223308	223306	223320	227306



Referans Kod	PIC 311	PIC 312	PIC 313	PIC 314	PIC 315	PIC 316	PIC 320	PIC 321	PIC 322	PIC 324
Size (mm) Δ 25	227332	227333	227334	227335	251956	227336	251952	227339	227340	227342
Δ 50	227360	227361	227362	227363	223317	227364	223309	227367	227368	227370
Δ 100	227307	227308	227309	227310	223318	227311	223310	227314	227315	227317



Referans Kod	PIC 327	PIC 329	PIC 334	PIC 336	PIC 337	PIC 349
Size (mm) Δ 25	251954	251953	223339	227348	227349	227350
Δ 50	223313	223311	223340	227375	227276	227274
Δ 100	223314	223312	223341	227322	227277	227275



Referans Kod	PIC 467
Size (mm) Ø 25	251965
Ø 50	223333
Ø 100	223334

# BMP™ 21

## LABEL PRINTER



- Endüstriyel kullanım için özel dayanıklı dış yüzey
- 203 dpi çözünürlükte kaliteli termal transfer baskı
- Geniş LCD ekran ( 3 satır )
- Hem sağ hem de sol elle kesme imkanı veren kesici ünite
- Sahada taşımaya ve kullanımı kolaylaştıran taşıma kiti
- Aydınlatma ünitesi sayesinde karanlık ortamlarda dahi çalışma imkanı
- Hem kablo hem de pano ve dış ortam etiketleri basabilme
- Isıyla daralan makaron ve diğer kablo etiketleri basabilme
- Seri oluşturma
- Barkod basma
- 6 farklı dil seçeneği

## BRADY BMP 21



KOD	CİNSİ	FİYATI / €
BRAD-110889	BMP 21 Yazıcı	225.00 €
BRAD-110416	220 V Adaptör	66.67 €

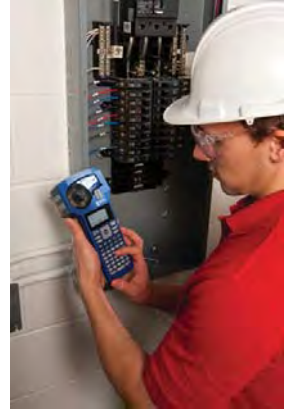

KOD	EN (mm)	UZUNLUK (mm)	TANIM	KULLANIM ALANI	BİRİM / €
BRAD-M21-125-C-342	5.96	2,1M	B342 siyah baskı, malzeme rengi beyaz	Daralan makaron mx kablo çapı 3,6mm	50.00 €
BRAD-M21-187-C-342	8.50	2,1M	B342 siyah baskı, malzeme rengi beyaz	Daralan makaron mx kablo çapı 5,3mm	51.67 €
BRAD-M21-250-C-342	11.15	2,1M	B342 siyah baskı, malzeme rengi beyaz	Daralan makaron mx kablo çapı 7mm	53.33 €
BRAD-M21-375-C-342	16.38	2,1M	B342 siyah baskı, malzeme rengi beyaz	Daralan makaron mx kablo çapı 10,4mm	56.67 €
BRAD-M21-375-423	9.53	6,4M	B423 siyah baskı, malzeme rengi beyaz	Polyester - pano	28.33 €
BRAD-M21-500-423	12.70	6,4M	B423 siyah baskı, malzeme rengi beyaz	Polyester - pano	30.00 €
BRAD-M21-750-423	19.05	6,4M	B423 siyah baskı, malzeme rengi beyaz	Polyester - pano	30.00 €
BRAD-M21-750-427	19.05	4,2M	B427 siyah baskı, malzeme rengi beyaz	Laminasyonlu sarılan - kablo için	35.00 €
BRAD-M21-1000-427	25.40	4,2M	B427 siyah baskı, malzeme rengi beyaz	Laminasyonlu sarılan - kablo için	43.33 €
BRAD-M21-1250-427	30.48	4,2M	B427 siyah baskı, malzeme rengi beyaz	Laminasyonlu sarılan - kablo için	45.00 €
BRAD-M21-1500-427	38.10	4,2M	B427 siyah baskı, malzeme rengi beyaz	Laminasyonlu sarılan - kablo için	46.67 €
BRAD-M21-375-430	9.53	6,4M	B430 siyah baskı, malzeme rengi fleffaf	Polyester - pano	30.00 €
BRAD-M21-500-430	12.70	6,4M	B430 siyah baskı, malzeme rengi fleffaf	Polyester - pano	30.00 €
BRAD-M21-750-430	19.05	6,4M	B430 siyah baskı, malzeme rengi fleffaf	Polyester - pano	31.67 €
BRAD-M21-375-461	9.53	6,4M	B461 siyah baskı, malzeme rengi beyaz	Polyester - pano	31.67 €
BRAD-M21-500-461	12.70	6,4M	B461 siyah baskı, malzeme rengi beyaz	Polyester - pano	31.67 €
BRAD-M21-750-461	19.05	6,4M	B461 siyah baskı, malzeme rengi beyaz	Polyester - pano	35.00 €
BRAD-M21-375-488	9.53	6,4M	B488 siyah baskı, malzeme rengi beyaz	Polyester - pano	33.33 €
BRAD-M21-500-488	12.70	6,4M	B488 siyah baskı, malzeme rengi beyaz	Polyester - pano	35.00 €
BRAD-M21-750-488	19.05	6,4M	B488 siyah baskı, malzeme rengi beyaz	Polyester - pano	36.67 €
BRAD-M21-375-499	9.53	4,8M	B499 siyah baskı, malzeme rengi beyaz	Nylon kumaş - pano ve kablo	31.67 €
BRAD-M21-500-499	12.70	4,8M	B499 siyah baskı, malzeme rengi beyaz	Nylon kumaş - pano ve kablo	31.67 €
BRAD-M21-750-499	19.05	4,8M	B499 siyah baskı, malzeme rengi beyaz	Nylon kumaş - pano ve kablo	33.33 €
BRAD-M21-375-499-TB	9.53	4,8M	B499 siyah baskı, malzeme rengi beyaz	Nylon kumaş - klemens	33.33 €
BRAD-M21-500-499-TB	12.70	4,8M	B499 siyah baskı, malzeme rengi beyaz	Nylon kumaş - klemens	35.00 €
BRAD-M21-375-595-RD	9.53	6,4M	B580 beyaz baskı, malzeme rengi kırmızı	Vinyl - pano ve kablo	30.00 €
BRAD-M21-500-595-RD	12.70	6,4M	B580 beyaz baskı, malzeme rengi kırmızı	Vinyl - pano ve kablo	30.00 €
BRAD-M21-750-595-RD	19.05	6,4M	B580 beyaz baskı, malzeme rengi kırmızı	Vinyl - pano ve kablo	31.67 €
BRAD-M21-375-595-BL	9.53	6,4M	B580 beyaz baskı, malzeme rengi mavi	Vinyl - pano ve kablo	30.00 €
BRAD-M21-500-595-BL	12.70	6,4M	B580 beyaz baskı, malzeme rengi mavi	Vinyl - pano ve kablo	30.00 €
BRAD-M21-750-595-BL	19.05	6,4M	B580 beyaz baskı, malzeme rengi mavi	Vinyl - pano ve kablo	31.67 €
BRAD-M21-375-595-GN	9.53	6,4M	B580 beyaz baskı, malzeme rengi yeşil	Vinyl - pano ve kablo	30.00 €
BRAD-M21-500-595-GN	12.70	6,4M	B580 beyaz baskı, malzeme rengi yeşil	Vinyl - pano ve kablo	30.00 €
BRAD-M21-750-595-GN	19.05	6,4M	B580 beyaz baskı, malzeme rengi yeşil	Vinyl - pano ve kablo	31.67 €
BRAD-M21-375-595-WT	9.53	6,4M	B580 siyah baskı, malzeme rengi beyaz	Vinyl - pano ve kablo	30.00 €
BRAD-M21-500-595-WT	12.70	6,4M	B580 siyah baskı, malzeme rengi beyaz	Vinyl - pano ve kablo	30.00 €
BRAD-M21-750-595-WT	19.05	6,4M	B580 siyah baskı, malzeme rengi beyaz	Vinyl - pano ve kablo	31.67 €
BRAD-M21-375-595-YL	9.53	6,4M	B580 siyah baskı, malzeme rengi sarı	Vinyl - pano ve kablo	28.33 €
BRAD-M21-500-595-YL	12.70	6,4M	B580 siyah baskı, malzeme rengi sarı	Vinyl - pano ve kablo	30.00 €
BRAD-M21-750-595-YL	19.05	6,4M	B580 siyah baskı, malzeme rengi sarı	Vinyl - pano ve kablo	31.67 €
BRAD-M21-375-595-OR	9.53	6,4M	B580 siyah baskı, malzeme rengi turuncu	Vinyl - pano ve kablo	28.33 €
BRAD-M21-500-595-OR	12.70	6,4M	B580 siyah baskı, malzeme rengi turuncu	Vinyl - pano ve kablo	30.00 €
BRAD-M21-750-595-OR	19.05	6,4M	B580 siyah baskı, malzeme rengi turuncu	Vinyl - pano ve kablo	31.67 €



BRADY®

Jet ID

## INK JET COLOUR PRINTER

KOD	cinsi	FİYATI / €
BRAD-JETIDK	JED ID yazıcı + 4 mürekkep kartuşu + Matrix yazılım	☺
BRAD-JETCNE	Siyah mürekkep kartuşu	150.00 €
BRAD-JETCCI	Cyan mürekkep kartuşu	150.00 €
BRAD-JETCMA	Magenta mürekkep kartuşu	150.00 €
BRAD-JETCGI	Sarı mürekkep kartuşu	150.00 €
BRAD-IDVARE	Atık mürekkep tankı	200.00 €

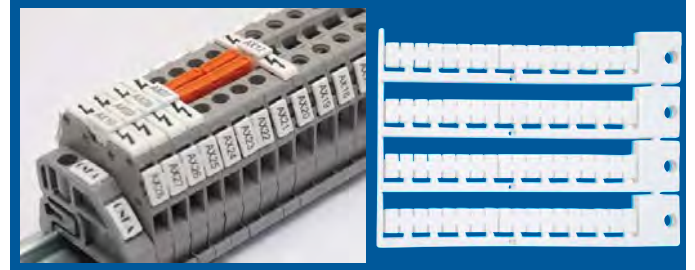

KOD	EBAT	RENK	TANIM	BİRİM / €	K./AD.
BRAD-MFTB-6x10-6-WD	6mm x 10mm	beyaz	2,5mm <sup>2</sup> ONKA Klemens etiketi	0.117 €	1000
BRAD-MFTB-6x10-WT-WDC	6mm x 10mm	beyaz	4mm <sup>2</sup> ONKA Klemens etiketi	0.084 €	1024
BRAD-IFH-15x27-WT	15mm x 27mm	beyaz	15x27mm Buton Etiketi	0.146 €	480
BRAD-IFH-15x27-YL	15mm x 27mm	sarı	15x27mm Buton Etiketi	0.162 €	480
BRAD-IFH-15x27-SV	15mm x 27mm	gümüş	15x27mm Buton Etiketi	0.162 €	480
BRAD-IFH-15x49-WT	15mm x 49mm	beyaz	15x49mm Genel Amaçlı Etiketi	0.292 €	240
BRAD-IFH-15x49-YL	15mm x 49mm	sarı	15x49mm Genel Amaçlı Etiketi	0.292 €	240
BRAD-IFH-15x49-SV	15mm x 49mm	gümüş	15x49mm Genel Amaçlı Etiketi	0.292 €	240
BRAD-IFH-15x67-WT	15mm x 67mm	beyaz	15x67mm Genel Amaçlı Etiketi	0.324 €	120
BRAD-IFH-15x67-YL	15mm x 67mm	sarı	15x67mm Genel Amaçlı Etiketi	0.324 €	120
BRAD-IFH-15x67-SV	15mm x 67mm	gümüş	15x67mm Genel Amaçlı Etiketi	0.324 €	120
BRAD-FCC-4x10-WT-4STR	4mm x 10 mm	beyaz	4x10 Şeffaf Tüp içine konan kablo etiketi	0.038 €	2048
BRAD-FCC-4x10-YL-4STR	4mm x 10 mm	sarı	4x10 Şeffaf Tüp içine konan kablo etiketi	0.038 €	2048
BRAD-IFCC-4x15-WT-4STR	4mm x 15mm	beyaz	4x15 Şeffaf Tüp içine konan kablo etiketi	0.052 €	2048
BRAD-IFCC-4x15-YL-4STR	4mm x 15mm	sarı	4x15 Şeffaf Tüp içine konan kablo etiketi	0.052 €	2048
BRAD-IFCC-4x23-WT-4STR	4mm x 23mm	beyaz	4x23 Şeffaf Tüp içine konan kablo etiketi	0.146 €	1020
BRAD-IFCC-4x23-YL-4STR	4mm x 23mm	sarı	4x23 Şeffaf Tüp içine konan kablo etiketi	0.145 €	1021
BRAD-IFCC-4x30-WT-3DTR	4mm x 30mm	beyaz	4x30 Şeffaf Tüp içine konan kablo etiketi	0.155 €	1020
BRAD-IFCC-4x30-YL-3DTR	4mm x 30mm	sarı	4x30 Şeffaf Tüp içine konan kablo etiketi	0.155 €	1020
BRAD-SACM-9x15-WT	9mm x 15mm	beyaz	9x15mm röle ve kontaktör için çok Amaçlı Etiketi	0.238 €	1408
BRAD-SACM-9x15-YL	9mm x 15mm	sarı	9x15mm röle ve kontaktör için çok Amaçlı Etiketi	0.238 €	1408
BRAD-SACM-9x20-YL	9mm x 20mm	sarı	9x20mm röle ve kontaktör için çok Amaçlı Etiketi	0.213 €	600
BRAD-SACM-9x20-WT	9mm x 20mm	beyaz	9x20mm röle ve kontaktör için çok Amaçlı Etiketi	0.213 €	600
BRAD-CTRP-115x80	115mm x 80mm	beyaz	115x80mm pano etiketi	4.364 €	20
BRAD-CTRP-115x80	115mm x 80mm	şeffaf	115x80mm transparan loriyucu kapak	4.364 €	10
BRAD-CTRP-100x60	100mm x 60mm	beyaz	100x60mm pano etiketi	3.398 €	20
BRAD-CTRP-100x60	100mm x 60mm	şeffaf	100x60mm transparan loriyucu kapak	3.398 €	10
BRAD-WM-ICS-4x16-WT-DIAS	4x16mm	beyaz	direk üzerine yazılan Kablo etiketi, 0,5-1,5mm <sup>2</sup> kesit aralığı	0.074 €	672
BRAD-WM-ICS-4x16-YL-DIAS	4x16mm	sarı	direk üzerine yazılan Kablo etiketi, 0,5-1,5mm <sup>2</sup> kesit aralığı	0.074 €	672
BRAD-WM-ICS-4x16-WT-DIAL	4x16mm	beyaz	direk üzerine yazılan Kablo etiketi, 1-4mm <sup>2</sup> kesit aralığı	0.074 €	528
BRAD-WM-ICS-4x16-YL-DIAL	4x16mm	sarı	direk üzerine yazılan Kablo etiketi, 1-4mm <sup>2</sup> kesit aralığı	0.074 €	528
BRAD-WM-ICS-4x11-WT-DIAS	4x11mm	beyaz	direk üzerine yazılan Kablo etiketi, 0,5-1,5mm <sup>2</sup> kesit aralığı	0.071 €	672
BRAD-WM-ICS-4x11-YL-DIAS	4x11mm	sarı	direk üzerine yazılan Kablo etiketi, 0,5-1,5mm <sup>2</sup> kesit aralığı	0.071 €	672
BRAD-WM-ICS-4x11-WT-DIAL	4x11mm	beyaz	direk üzerine yazılan Kablo etiketi, 1-4mm <sup>2</sup> kesit aralığı	0.071 €	528
BRAD-WM-ICS-4x11-YL-DIAL	4x11mm	sarı	direk üzerine yazılan Kablo etiketi, 1-4mm <sup>2</sup> kesit aralığı	0.071 €	528

## DÖRTLÜ KUMANDA KUTUSU



KOD	AÇIKLAMA	AD. / ʈ	K. AD.
ASG-HJ9-4	B5542 Stop(No),BA3341 Start beyaz, oklu (No), BA3341 Start beyaz, oklu (No B)22 0-1 Mandal(No+Nc), PG 13.5 kablo rekor, priz, serigraf (İngilizce - Türkçe) yazı, Miknatis Taban , Asansörler için.	25.00	30

## TEKLİ KUMANDA KUTUSU



KOD	AÇIKLAMA	AD. / ʈ	K. AD.
ASG-J174H29	Emergency etiketli	8.00	100

## LİMİT SWITCH



KOD	AÇIKLAMA	AD. / ʈ	K. AD.
ASG-RLS-191	Ø 50 mm Makara, Ayarlanabilir (Her Yöne) Metal Kol, Plastik Gövde	1	100

## LİMİT SWITCH



KOD	AÇIKLAMA	AD. / ʈ	K. AD.
CLS-103 R	Resetli dikey pim makara ø: 12 Metal	1	50

## ASANSÖR KAPI SWİCH



KOD	AÇIKLAMA	AD. / ʈ	K. AD.
AYP-001	Asansör kapı swich'i Fi kontak	1	1

## Ø 16 VATMAN ANAHTAR (KONTAK 2N0)



KOD	AÇIKLAMA	AD. / ʈ	K. AD.
MBJ-16912	Anahtar Çıkamaz 0 - 1	1	1
MBJ-16922	Anahtar Çıkar 0 - 1	1	1

## KÖPRÜ DİYOT

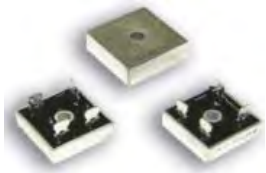

KOD	AÇIKLAMA	AD. / ʈ	K. AD.
ASG-KBPC-3510	35 A / 1000 V	2.80	50

## MİKNATIS



KOD	AÇIKLAMA	AD. / ʈ	K. AD.
ASG-22 x 7	22mm Çap,7mm Yükseklik, Kırmızı Boyalı	0.16	2.000
10 cm Şerit Mıknatis	8 mm Yükseklik, Hidrolik Asansörler İçin	1.30	360
20 cm Şerit Mıknatis	8 mm Yükseklik, Hidrolik Asansörler İçin	2.60	160
30 cm Şerit Mıknatis	8 mm Yükseklik, Hidrolik Asansörler İçin	3.80	120
40 cm Şerit Mıknatis	8 mm Yükseklik, Hidrolik Asansörler İçin	5.10	80





Ø22 mm SİNYAL LAMBASI LED

KOD	AÇIKLAMA	RENK	AD. / ʘ	K. AD.
ASG-AD22-42220	Ø 22 mm, LED, 220 VAC	Kırmızı	2.20	10
ASG-AD22-31220	Ø 22 mm, LED, 220 VAC	Yeşil	2.20	10
ASG-AD22-51220	Ø 22 mm, LED, 220 VAC	Sarı	2.20	10
ASG-AD22-61220	Ø 22 mm, LED, 220 VAC	Mavi	2.70	10
ASG-AD22-11220	Ø 22 mm, LED, 220 VAC	Beyaz	2.70	10

Ø22 mm LAY 5 SERİSİ PLASTİK BUTON

YAYLI BUTON 3A/240 V AC

KOD	AÇIKLAMA	AD. / ʘ	K. AD.
ASG-EA31	Ø 22 mm, Start Buton Yeşil NO	2.20	20
ASG-EA42	Ø 22 mm, Start Buton Kırmızı NC	2.20	20
ASG-EA51	Ø 22 mm, Start Buton Sarı NO	2.20	20
ASG-EA21	Ø 22 mm, Start Buton Siyah NO	2.20	20
ASG-EA3341	Ø 22 mm, Start Buton Beyaz, Oklu NO	2.30	20
ASG-EA3351	Ø 22 mm, Start Buton Siyah, Oklu NO	2.30	20

Ø22 mm LAY 5 SERİSİ METAL BUTON

YAYLI BUTON 3A/240 V AC

KOD	AÇIKLAMA	AD. / ʘ	K. AD.
ASG-BA31	Ø 22 mm, Start Buton Yeşil NO	2.80	20
ASG-BA42	Ø 22 mm, Start Buton Kırmızı NC	2.80	20
ASG-BA51	Ø 22 mm, Start Buton Sarı NO	2.80	20
ASG-BA21	Ø 22 mm, Start Buton Siyah NO	2.80	20
ASG-BA3341	Ø 22 mm, Start Buton Beyaz, Oklu NO	2.90	20
ASG-BA3351	Ø 22 mm, Start Buton Siyah, Oklu NO	2.90	20

MANTAR BUTON 3A/240 V AC

KOD	AÇIKLAMA	AD. / ʘ	K. AD.
ASG-ES542	Ø 22 mm, Acil Stop Buton Kırmızı NC	3.40	20

MANTAR BUTON 3A/240 V AC

KOD	AÇIKLAMA	AD. / ʘ	K. AD.
ASG-BS542	Ø 22 mm, Acil Stop Buton Kırmızı NC	3.80	20

MANDAL BUTON 3A/240 V AC

KOD	AÇIKLAMA	AD. / ʘ	K. AD.
ASG-EJ21	Ø 22 mm, Mandal Buton Uzun 0-1 NO	2.60	20
ASG-ED21	Ø 22 mm, Mandal Buton Kısa 0-1 NO	2.60	20
ASG-ED33	Ø 22 mm, Mandal Buton Kısa 1-0-2 2NO	3.60	20
ASG-EL8325	Ø 22 mm, İkiz Buton 1 NO + 1NC	4.60	20

MANDAL BUTON 3A/240 V AC

KOD	AÇIKLAMA	AD. / ʘ	K. AD.
ASG-BJ21	Ø 22 mm, Mandal Buton Uzun 0-1 NO	3.10	20
ASG-BD21	Ø 22 mm, Mandal Buton Kısa 0-1 NO	3.10	20
ASG-BD33	Ø 22 mm, Mandal Buton Kısa 1-0-2 2NO	4.20	20

BUTON BLOĞU 3A/240 V AC

KOD	AÇIKLAMA	AD. / ʘ	K. AD.
ASG-BE101	Kontak Bloğu NO	1.10	150
ASG-BE102	Kontak Bloğu NC	1.10	150

ANAHTARLI BUTON 3A/240 V AC

KOD	AÇIKLAMA	AD. / ʘ	K. AD.
ASG-BG21	Ø 22 mm, Anahtarlı Buton 0-1 NO	6.00	20

1 KUTUPLU OTOMATİK SİGORTALAR 3kA C TİPİ 230-400 V

KOD	ANMA AKIMI (A)	AD. / ʘ	K. AD.
ASG-KNB1-63	2A	3.75	12
ASG-KNB1-63	4A	3.75	12
ASG-KNB1-63	6A	3.75	12
ASG-KNB1-63	10A	3.70	12
ASG-KNB1-63	16A	3.70	12

MEKANİK KAÇAK AKIM RÖLESİ (MONOFAZE) 240 V 30 mA

KOD	KUTUP SAYISI	ANMA AKIMI	AD. / ʘ	K. AD.
ASG-KNL1-63	1P+N	25 A	25.50	100



### AC GÜÇ KONTAKTÖRLERİ-AC 220V BOBİNLİ

KOD	ANMA AKIMI (A)	ANMA GÜCÜ 380V AC (kW)	TERMİK AKIM (Ith) (A)	Y. KON-TAK NA-NK	AD. / ʘ	K. AD.
ASG-SMC1-09	9A	4kW	9A	9A	23.00	60
ASG-SMC1-22	22A	11kW	22A	22A	29.50	60
ASG-SMC1-32	32A	15kW	32A	32A	42.50	40
ASG-SMC1-40	40A	18.5kW	40A	40A	46.00	40
ASG-SMC1-85	85A	45kW	85A	85A	92.50	20

### YARDIMCI KONTAK BLOĞU / DZ518(GV2)

KOD	MONTAJ	KONTAK	AD. / ʘ	K. AD.
ASG-AN11	Yan	1 No + 1 Nc	8.00	10

### YARDIMCI KONTAK BLOĞU / SMC1

KOD	MONTAJ	KONTAK	AD. / ʘ	K. AD.
ASG-AU - 11	Üst	1 No + 1 Nc	6.00	40
ASG-AU - 22	Üst	2 No + 2 Nc	10.00	20

### YARDIMCI KONTAK BLOĞU

KOD	MONTAJ	KONTAK	AD. / ʘ	K. AD.
ASG-LA1- DN11	Üst	1 No + 1 Nc	3.50	400
ASG-LA1 -DN22	Üst	2 No + 2 Nc	5.70	250

### TERMİK RÖLE (UKH) (Kontaktöre Montaj)

KOD	TERMİK AYAR SAHASI	BİRLİKTE KULLANILAN KONTAKTÖR TİPİ	AD. / ʘ	K. AD.
ASG-UKH-22,7-10	7-10A	SMC1 9-40	21.50	120
ASG-UKH-22,9-13	9-13A	SMC1 9-40	21.50	120

### TERMİK RÖLE (JR28) (Kontaktöre Montaj)

KOD	TERMİK AYAR SAHASI	AD. / ʘ	K. AD.
ASG-JR28-5.5-8	5.5-8A	14.75	100
ASG-JR28-7-10	7-10A	14.75	100
ASG-JR28-9-13	9-13A	14.75	100

### TERMİK RÖLE (JRS2) (Raya Montaj)

KOD	TERMİK AYAR SAHASI	AD. / ʘ	K. AD.
ASG-JRS2 6.3-10	6.3-10A	25.00	40
ASG-JRS2 10-16	10-16A	25.00	40

### MOTOR KORUMA ŞALTERLERİ

KOD	TERMİK AYAR SAHASI	AD. / ʘ	K. AD.
ASG-DZ518(GV2) 2.5-4	2.5-4 A	35.50	50
ASG-DZ518(GV2) 4-6.3	4-6.3 A	35.50	50
ASG-DZ518(GV2) 6-10	6-10 A	35.50	50
ASG-DZ518(GV2) 9-14	9-14 A	35.50	50
ASG-DZ518(GV2) 10-16	10-16A	35.50	50
ASG-DZ518(GV2) 13-18	13-18 A	35.50	50
ASG-DZ518(GV2) 17-23	17-23A	35.50	50
ASG-DZ518(GV2) 20-25	20-25A	35.50	50
ASG-DZ518(GV2) 24-32	24-32A	35.50	50

**OSKAR<sup>®</sup>**



## KOLLU PANO KİLİDİ (İSPANYOLET MEKANİZMALI)



KOD	Cinsi	AD. / ʘ	K. / AD.
OSKA 001	KOLLU PANO KİLİDİ (İSP. ZAMAK MEKANİZMALI-KAPLAMALI)	14,00	50
OSKA 002	KOLLU PANO KİLİDİ (İSPANYOLET ZAMAK MEKANİZMALI)	13,00	50
OSKA 002-A	KOLLU PANO KİLİDİ (ASMA KİLİT HAMİLLİ- İSP. MEKANİZMALI)	15,00	50
OSKA 003	KOLLU PANO KİLİDİ (BARELSİZ- İSP. ZAMAK MEKANİZMALI)	12,00	50
OSKA 005	KOLLU PANO KİLİDİ (İSPANYOLET ZAMAK MEKANİZMALI)	13,00	50
OSKA 007	METAL KOLLU PANO KİLİDİ (İSP. MEKANİZMALI)	17,00	50
OSKA 007-A	METAL KOLLU PANO KİLİDİ (İSP. MEK.-ASMA KİLİT HAMİLLİ)	18,00	50
OSKA 007-B	KOLLU PANO KİLİDİ (İSP. MEK. BARELSİZ- ASMA KİLİTLİ)	17,00	50
OSKA 008	KOLLU PANO KİLİDİ İKOL-PLASTİK) YENİ	11,90	50
OSKA 008-1	KOLLU PANO KİLİDİ (KOL-METAL) YENİ	12,80	50
OSKA 009	KOLLU PANO KİLİDİ İKOL-PLASTİK) YENİ	12,60	50
OSKA 009-1	KOLLU PANO KİLİDİ (KOL-METAL) YENİ	14,00	50
OSKA 010	KOLLU PANO KİLİDİ (İSPAN. ZAMAK MEKANİZMALI) YENİ	14,00	50
OSKA 010-A	KOLLU PANO KİLİDİ (ASMA KİLİTLİ- İSP. MEKANİZMALI) YENİ	15,00	50
OSKA 208	KOLLU PANO KİLİDİ T - 2	11,20	50
OSKA 208 - A	KOLLU PANO KİLİDİ (ASMA KİLİT HAMİLLİ T - 2)	12,00	50
OSKA 208 - DB	KOLLU PANO KİLİDİ (DOUBLE BAREL T - 2)	10,00	50
OSKA 210	İSPANYOLET SİSTEMLİ PANO KİLİDİ	6,00	50

## KOLLU PANO KİLİDİ (MEKANİZMASIZ)



KOD	Cinsi	AD. / ʘ	K. / AD.
OSKA 001-2	KOLLU PANO KİLİDİ (İSP. MEKANİZMASIZ-KAPLAMALI)	12,60	50
OSKA 001-2-1	KOLLU PANO KİLİDİ (BARELSİZ- İSP. MEKANİZMASIZ)	10,00	50
OSKA 002-2	KOLLU PANO KİLİDİ (İSPANYOLET MEKANİZMASIZ)	12,00	50
OSKA 002-A-2	KOLLU PANO KİLİDİ (ASMA KİLİT HAMİLLİ- İSP. MEKANİZMASIZ)	13,00	50
OSKA 004	KOLLU PANO KİLİDİ (PASLANMAZ TOZ KAPAKLI)	11,20	50
OSKA 004-A	KOLLU PANO KİLİDİ (ASMA KİLİTİ-PASLANMAZ TOZ KAPAKLI)	12,00	50
OSKA 005-1	KOLLU PANO KİLİDİ	12,00	50
OSKA 006	PANO KİLİDİ (DB GÖBEKLİ)	3,80	50
OSKA 007-1	METAL KOLLU PANO KİLİDİ (İSP. MEKANİZMASIZ)	16,00	50
OSKA 007-1-B	KOLLU PANO KİLİDİ (ASMA KİLİT HAMİLLİ-BARELSİZ)	15,40	50
OSKA 008-2	KOLLU PANO KİLİDİ İKOL-PLASTİK) YENİ	9,10	50
OSKA 008-3	KOLLU PANO KİLİDİ (KOL-METAL) YENİ	10,50	50
OSKA 009-2	KOLLU PANO KİLİDİ İKOL-PLASTİK) YENİ	10,50	50
OSKA 009-3	KOLLU PANO KİLİDİ (KOL-METAL) YENİ	11,90	50
OSKA 010-1	KOLLU PANO KİLİDİ (İSPANYOLET MEKANİZMASIZ) YENİ	12,00	50
OSKA 010-1-A	KOLLU PANO KİLİDİ (ASMA KİLİTLİ İSP. MEKANİZMASIZ) YENİ	13,00	50
OSKA 206	KOLLU PANO KİLİDİ T - 1	8,00	50
OSKA 206-A	KOLLU PANO KİLİDİ (ASMA KİLİT HAMİLLİ T - 1)	9,00	50
OSKA 206-DB	KOLLU PANO KİLİDİ (DOUBLE BAREL T - 1)	7,60	50
OSKA 208-1	T-2 KOLLU PANO KİLİDİ-YENİ TİP	7,00	50
OSKA 210-1	T-3 PANO KİLİDİ (YENİ)	4,00	50

## GİZLİ MENTEŞELER



KOD	Cinsi	AD. / ʘ	K. / AD.
OSKA 300	YAYLI MİL MENTEŞE	1,70	100
OSKA 300-1	YAYLI MİL MENTEŞE	1,40	100
OSKA 300-2	YAYLI MİL MENTEŞE (10 mm)	1,70	100
OSKA 300-3	YAYLI MİL MENTEŞE (12 mm)	1,70	100
OSKA 308	SAC (GİZLİ PANO MENTEŞESİ)	1,70	100
OSKA 308-1	SAC-ORTASI YUVARLAK (GİZLİ PANO MENTEŞESİ)	1,70	100
OSKA 308-1-2	SAC-ORTASI ALÜMİNYUM (GİZLİ PANO MENTEŞESİ)	1,70	100
OSKA 308-2	SAC-PERÇ-VIDALI M5 SOMUNLU (GİZLİ PANO MENTEŞESİ)	1,70	100
OSKA 308-2-1	SAC- PERÇ- VID. ORTA YUVARLAK (GİZLİ PANO MENTEŞESİ)	1,70	100
OSKA 308-3	PASLANMAZ (GİZLİ PANO MENTEŞESİ)	4,00	100
OSKA 309	ALÜMİNYUM (GİZLİ PANO MENTEŞESİ)	1,70	100
OSKA 309 A	ZAMAK (GİZLİ PANO MENTEŞESİ)	1,70	100
OSKA 342	YENİ TİP SAC (GİZLİ PANO MENTEŞESİ)	1,80	100
OSKA 343	ZAMAK (GİZLİ PANO MENTEŞESİ)	3,20	100
OSKA 347	SAC PERÇİN VIDALI M5 SOM. (GİZLİ PANO MENTEŞESİ)	1,70	100
OSKA 348	ZAMAK - 110 DERECE (GİZLİ PANO MENTEŞESİ)	1,80	100
OSKA 349	ZAMAK (GİZLİ PANO MENTEŞESİ)	2,40	100
OSKA 354	SAC (GİZLİ PANO MENTEŞESİ)	2,80	100
OSKA 355	PANO ÖRTÜ SACI MENTEŞESİ	0,90	100
OSKA 356	GİZLİ PANO MENTEŞESİ	2,00	100



## PANO KAPAK MENTEŞELERİ

KOD	cinsi	AD. / ʘ	K. / AD.
OSKA 310	PANO KAP. MENT. (BÜYÜK - STATİK BOYALI )	4.00	50
OSKA 310 - K	PANO KAP. MENT. (BÜYÜK - KROM KAPLAMALI )	4.40	50
OSKA 310 - A	PANO KAP. MENT. (KÜÇÜK - STATİK BOYALI )	2.90	100
OSKA 310 - A - K	PANO KAP. MENT. (KÜÇÜK - KROM KAPLAMALI )	3.20	100
OSKA 311	180° GEÇME MENT. (KÜÇÜK - STATİK BOYALI )	1.70	100
OSKA 311 - K	180° GEÇME MENT. (KÜÇÜK - KROM KAPLAMALI )	1.90	100
OSKA 311 - P	180° GEÇME MENT. (KÜÇÜK - PLASTİK )	0.80	100
OSKA 311 - P-1	180° GEÇME MENT. (YENİ - PLASTİK )	0.80	100
OSKA 312	180° GEÇME MENT. (BÜYÜK - STATİK BOYALI )	2.40	100
OSKA 312-1	180° GEÇME MENT. (BÜYÜK - KROM KAPLAMALI )	2.60	100
OSKA 330-1-0	YATAKLI MENTEŞE (STATİK BOYALI-SİYAH )	2.60	100
OSKA 330-2-0	YATAKLI MENTEŞE (KROM KAPLAMALI )	2.90	100
OSKA 331	YENİ TİP PANO KAP. MENT. (STATİK BOYALI-SİYAH )	2.80	100
OSKA 333	KENAR MENTEŞESİ (STATİK BOYALI 180° - SİYAH )	2.80	100
OSKA 344	PANO KAPAK MENTEŞESİ , STATİK BOYALI	5.00	50



## YAYLI PANO KİLİTLERİ

KOD	cinsi	AD. / ʘ	K. / AD.
OSKA 201	YAYLI PANO KİLİDİ (DOUBLE)	2,40 TL	100
OSKA 201 - SB	YAYLI PANO KİLİDİ (DOUBLE-STATİK BOYALI - SİYAH)	2,40 TL	100
OSKA 201 - A	YAYLI PANO KİLİDİ (ÜÇGEN)	2,40 TL	100
OSKA 201 - A-1	YAYLI PANO KİLİDİ (ÜÇGEN-STATİK BOYALI-SİYAH)	2,40 TL	100
OSKA 201 - B	YAYLI PANO KİLİDİ (KARE)	2,40 TL	100
OSKA 201 - B-1	YAYLI PANO KİLİDİ (KARE-STATİK BOYALI-SİYAH)	2,40 TL	100
OSKA 201 - P	PLASTİK YAYLI PANO KİLİDİ (DOUBLE - ZAMAK GÖBEK)	1.70 TL	100
OSKA 201 - PU	PLASTİK YAYLI PANO KİLİDİ (ÜÇGEN - ZAMAK GÖBEK)	1.70 TL	100
OSKA 201 - PK	PLASTİK YAYLI PANO KİLİDİ (KARE - ZAMAK GÖBEK)	1.70 TL	100
OSKA 201 - PG	PLASTİK YAYLI PANO KİLİDİ (PLASTİK GÖBEK )	1.20 TL	100
OSKA 202	YAYLI PANO KİLİDİ (İSPANYOLET MANDALLI)	2.80 TL	100
OSKA 204	YAYLI PANO KİLİDİ (KELEBEK ANAHTARLI- METAL)	3.00 TL	100
OSKA 204 - SB	YAYLI PANO KİLİDİ (STATİK BOYALI - KELEBEK NAHTARLI)	3.00 TL	100
OSKA 205	YAYLI PANO KİLİDİ (KELEBEK ANAHTARLI- PLASTİK )	1.40 TL	100
OSKA 216	BİLYALI PANO KİLİDİ (ÜÇGEN)	2,30 TL	100
OSKA 230	SÜRGÜLÜ KİLİT (PLASTİK 1,20 mm.)	0,50 TL	500
OSKA 230-1	MINİ SÜRGÜLÜ KİLİT ( PLASTİK 1,20 mm.)	0,30 TL	500
OSKA 231	DÖRTGEN YAYLI PANO KİLİDİ (PLASTİK-SİYAH-ZAMAK)	1,30 TL	100
OSKA 231-1	DÖRTGEN YAYLI PANO KİLİDİ (PLASTİK-GRİ-ZAMAK)	1.30 TL	100
OSKA 231-2	DÖRTGEN YAYLI P. KİLİDİ (PLST. KOVAN-SİYAH)	1.60 TL	100
OSKA 231-3	DÖRTGEN YAYLI P. KİLİDİ (PLST. KOVAN-GRİ)	1.60 TL	100
OSKA 232	SİLİNDİRLİ KELEBEK KİLİT (STATİK BOYALI - SİYAH )	5.80 TL	100
OSKA 232-1	SİLİNDİRLİ KELEBEK KİLİT (KROM KAPLAMA )	6,20 TL	100
OSKA 242	SİLİNDİRLİ YAYLI PANO KİLİDİ (PASLANMAZ TOZ KAPAKLI)	4,40 TL	100
OSKA 243	SİLİNDİRLİ YAYLI PANO KİLİDİ (PASLANMAZ TOZ KAPAKLI)	4,00 TL	100
OSKA 244	SİLİNDİRLİ YAYLI PANO KİLİDİ (PASLANMAZ TOZ KAPAKLI)	4,00 TL	100
OSKA 245	ASMALI BİLYALI PANO KİLİDİ ( Ø 22mm-SAĞ VE SOL)	3,00 TL	100
OSKA 246	T KOLLU PANO KİLİDİ	8.00 TL	50
OSKA 247	L KOLLU PANO KİLİDİ	8.00 TL	50
OSKA 255	YAYLI PANO KİLİDİ (KELEBEK - ANAHTARLI - METAL)	2,80 TL	100
OSKA 255-1	YAYLI PANO KİLİDİ (KOVAN PLASTİK-KELEBEK METAL)	2,40 TL	100
OSKA 256	YAYLI PANO KİLİDİ (KELEBEK ANAHTARLI-PLASTİK)	1,40 TL	100
OSKA 256-1	YAYLI PANO KİLİDİ (KOVAN METAL-KELEBEK PLASTİK)	2,00 TL	100
OSKA 250	DÖRTGEN YAYLI PANO KİLİDİ (METAL MANDALLI-GRİ)	1,80 TL	100
OSKA 250-1	DÖRTGEN YAYLI PANO KİLİDİ (METAL MANDALLI-SİYAH)	1,80 TL	100

## ŞALT KAPAK KİLİTLERİ

233-30



KOD	Cinsi	AD. / ʘ	K. / AD.
OSKA 233-30	SALT KAPAK KİLİDİ (30 mm.)	4,20 TL	100
OSKA233-35	SALT KAPAK KİLİDİ (35 mm.)	4,40 TL	100
OSKA233-40	SALT KAPAK KİLİDİ (40 mm.)	4,60 TL	100
OSKA233-50	SALT KAPAK KİLİDİ (50 mm.)	5,00 TL	100
OSKA233-60	SALT KAPAK KİLİDİ (60 mm.)	5,20 TL	100

## MİNİ YAYLI PANO KİLİTLERİ KİLİTLERİ



KOD	Cinsi	AD. / ʘ	K. / AD.
OSKA 236	MİNİ YAYLI PANO KİLİDİ (KROM KAPLAMA - KOLLU)	1.90 TL	100
OSKA 236-1	MİNİ YAYLI PANO KİLİDİ (SİYAH STATİK BOYALI - KOLLU)	1.90 TL	100
OSKA 237	MİNİ YAYLI PANO KİLİDİ (DOUBLE-KROM KAPLAMALI)	1.90 TL	100
OSKA 237-1	MİNİ YAYLI PANO KİLİDİ (DOUBLE - STATİK BOYALI)	1.90 TL	100
OSKA 238	MİNİ YAYLI PANO KİLİDİ (ÜÇGEN-KROM KAPLAMALI)	1.90 TL	100
OSKA 238-1	MİNİ YAYLI PANO KİLİDİ (ÜÇGEN-STATİK BOYALI - SİYAH)	1.90 TL	100
OSKA 239	MİNİ YAYLI PANO KİLİDİ (KARE-KROM KAPLAMALI)	1.90 TL	100
OSKA 239-1	MİNİ YAYLI PANO KİLİDİ (KARE - STATİK BOYALI - SİYAH)	1.90 TL	100
OSKA 240	MİNİ YAYLI PANO KİLİDİ (TORNAVİDA BAŞLI-KROM)	1.90 TL	100
OSKA 240-1	MİNİ YAYLI PANO KİLİDİ (TORNAVİDA BAŞLI-STATİK BOYALI)	1.90 TL	100
OSKA 241	MİNİ YAYLI PANO KİLİDİ (PLASTİK KELEBEK)	1,10 TL	100

## KLİPS GEÇMELİ YAYLI PANO KİLİTLERİ

KOD	Cinsi	AD. / ʘ	K. / AD.
OSKA 257	TUTAMAKLI PLS. YAYLI PANO KİLİDİ (1333 ŞİFRELİ)	3.80 TL	100
OSKA 257-1	TUTAMAKLI PLS. YAYLI PANO KİLİDİ (DB GÖBEK)	1.60 TL	100
OSKA 257-2	TUTAMAKLI PLS. YAYLI PANO KİLİDİ (ÜÇGEN GÖBEK)	1.60 TL	100
OSKA 257-3	TUTAMAKLI PLS. YAYLI PANO KİLİDİ (KARE GÖBEK)	1.60 TL	100
OSKA 258	KLİPS GEÇMELİ PLS YAYLI PANO KİLİDİ (1333 ŞİFRELİ)	3.80 TL	100
OSKA 258-1	KLİPS GEÇMELİ PLS YAYLI PANO KİLİDİ (DB GÖBEK)	1.60 TL	100
OSKA 258-2	KLİPS GEÇMELİ PLS YAYLI PANO KİLİDİ (ÜÇGEN GÖBEKLİ)	1.60 TL	100
OSKA 258-3	KLİPS GEÇMELİ PLS YAYLI PANO KİLİDİ (KARE GÖBEKLİ)	1.60 TL	100
OSKA 205-1	KLİPS GEÇMELİ PLS KELEBEK KİLİT	1.30 TL	100

## YAYLI PANO KİLİTLERİ VE ANAHTARLARI

KOD	Cinsi	AD. / ʘ	K. / AD.
OSKA 203-1	YAYLI PANO KİLİT ANAH. (DOUBLE)	1.10	100
OSKA 203 -1-1	YAYLI PANO KİLİT ANAH. (ÜÇGEN)	1.10	100
OSKA 203 -1-2	YAYLI PANO KİLİT ANAH. (KARE)	1.10	100
OSKA 203-2	YAYLI PANO KİLİT ANAH. (MİNİ DOUBLE)	0.70	100
OSKA 203-2-1	YAYLI PANO KİLİT ANAH. (KÜÇÜK ÜÇGEN)	0.90	100
OSKA 203-2-2	YAYLI PANO KİLİT ANAH. (KÜÇÜK KARE)	0.90	100
OSKA 203-2-3	YAYLI PANO KİLİT ANAH. (MİNİK ÜÇGEN)	0.70	100
OSKA 203-2-4	YAYLI PANO KİLİT ANAH. (MİNİK KARE)	0.70	100
OSKA 203-3	YAYLI PANO KİLİT ANAH. (PLASTİK)	0.24	100
OSKA 203-4	YAYLI PANO KİLİT ANAH. (ÜÇGEN-YENİ)	1.00	100
OSKA 203-5	YAYLI PANO KİLİT ANAH. (KÜÇÜK DOUBLE)	0.90	100

## PLASTİK PANO KİLİTLERİ



KOD	Cinsi	AD. / ʘ	K. / AD.
OSKA 221	ALYEN ANAHTARLI PANO KİLİDİ	3.40	100
OSKA 221 - A	ALYEN ANAHTAR	0.40	100
OSKA 222	KALDIR ÇEVİR PANO KİLİDİ (PLASTİK)	1.30	100
OSKA 223	MANDALLI KİLİT (PLASTİK) - YENİ TİP	3.00	100
OSKA 224	PANO MANDALI (PLASTİK)	0.30	100
OSKA 020	PLASTİK FONKSİYONEL KİLİT	1.90	100
OSKA 021	PLAS. FONKSİYONEL KİLİT (OTOMATİK)	2.40	100
OSKA 030-M1	YENİ TİP PLS DİLLİ - YENİ TİP	1.40	100
OSKA 030-M2	YENİ TİP ÇELİK DİLLİ - YENİ TİP	1.90	100

## ÇEKMECE, DOSYA VE DOLAP KİLİTLERİ



KOD	CİNSİ	AD. / ʘ	K. / AD.
OSKA 101	T-1 MAN. KİLİT (ŞİFRELİ)	3.30	100
OSKA 101 -1	T-1 MAN. KİLİT (BİRBİRİNİ AÇAR)	3.30	100
OSKA 101 -2	KANCALI MANDAL-ŞİFRELİ	3.30	100
OSKA 101-3	MANDALLI KİLİT (H=20 mm - ŞİFRELİ)	3.30	100
OSKA 101-4	ŞİFRELİ - PASLANMAZ TOZ KAPAKLI	3.90	100
OSKA 103	ASMALI MANDALLI KİLİT	2.80	100
OSKA 103 -E	EĞRİ MANDALLI	2.80	100
OSKA 104	EĞRİ MANDALLI KİLİT (ŞİFRELİ)	3.30	100
OSKA 105	T ÇELİK DOLAP KOLLU KİLİT	8.50	50
OSKA 105-1	L ÇELİK DOLAP KOLLU KİLİT	8.50	50
OSKA 106	(YUVARLAK - STATİK BOYALI)	6.40	50
OSKA 106 -2	(KARE-STATİK BOYALI)	6.40	50
OSKA 106 -3	(KARE-KROM KAPLAMALI)	7.20	50
OSKA 106-4	(KARE-KROM KAPLAMALI)	6.00	50
OSKA 106-5	(KARE-KROM KAPLAMALI)	6.00	50
OSKA 106-5-1	(KARE-KROM KAPLAMALI)	7.20	50
OSKA 108	KELEBEK-SAĞ /SOL	3.00	100
OSKA 108-1	KELEBEK-SAĞ / SOL-TIRNAKLI	3.00	100
OSKA 111	KİLİT KARŞILIĞI	0.20	1000
OSKA 112	İSPAN. MANDALLI- ŞİFRELİ	3.30	100
OSKA 113	MAND. KİLİT (TORNAVİDA BAŞLI)	2.60	100
OSKA 114	MİNİ MAND. KİLİT (ŞİFRELİ)	3.30	100
OSKA 115	DOLAP KİLİDİ (PLASTİK)	4.40	50

## PİRİNÇ MANDALLI KİLİTLER



KOD	CİNSİ	AD. / ʘ	K. / AD.
OSKA-120	Kısa Mandallı Kilit (Pirinç)	9.00	50
OSKA-121	Uzun Mandallı Kilit (Pirinç)	9.60	50
OSKA-123	Kısa Üiversal Kilit (Pirinç)	9.20	50
OSKA-124	Uzun Üiversal Kilit (Pirinç)	9.80	50
OSKA-125	Kartoteks Kilit (Pirinç)	10.00	50
OSKA-126	Etejer Kilit (Pirinç)	9.20	50
OSKA-127	Alyeli Uzun Mandallı Kilit (Pirinç)	8.40	50
OSKA-128	Yarım Barel (Pirinç)	13.00	50

## KÜP MENTEŞELER

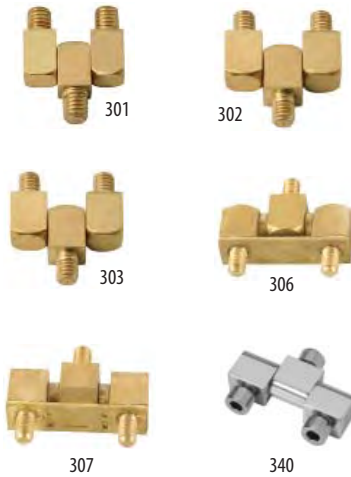

KOD	CİNSİ	AD. / ʘ	K. / AD.
OSKA-301	8 mm. Prinç (Somunlu)	1.40	200
OSKA-302	10 mm. Prinç (Somunlu)	1.80	200
OSKA-302-K	10 mm. Prinç (Krom Kaplamalı)	2.20	200
OSKA-303	12 mm. Prinç (Somunlu)	2.90	200
OSKA-303-K	12 mm. Prinç (Krom Kaplamalı)	3.40	200
OSKA-304	10 mm. Demir (Somunlu)	1.40	200
OSKA-305	12 mm. Demir (Somunlu)	1.90	200
OSKA-306	12 mm. Prinç (Bağlantılı)	4.60	100
OSKA-306-K	12 mm. Prinç (Bağ.-Krom Kap.)	5.20	100
OSKA-307	16 mm. Prinç (Bağlantılı)	8.00	100
OSKA-307-K	16 mm. Prinç (Bağ.-Krom Kap)	8.40	100
OSKA-332	12 mm Prinç (M6-Somunlu)	4.00	100
OSKA-340	Profil Ment. Prinç (Küçük-Kr. Kap.)	8.00	100
OSKA-341	Profil Ment. Prinç (Büyük-Kr. Kap.)	9.00	100

## PASLANMAZ MENTEŞELER

KOD	CİNSİ	AD. / ʘ	K. / AD.
OSKA-300-1	YAYLI MİL MENTEŞE (SAC)	2.50	100
OSKA-308-3	GİZLİ PANO MENTEŞESİ (M5 x 6 YSB CİVATALI - PASLANMAZ)	4.00	100
OSKA-342	GİZLİ PANO MENTEŞESİ (SAC)	4.00	100
OSKA-354	GİZLİ PANO MENTEŞESİ (SAC)	5.60	100
OSKA-356	GİZLİ PANO MENTEŞESİ (SAC)	5.00	100

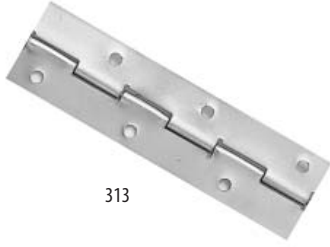

313

## SAC MENTEŞELER

KOD	Cinsi	AD. / ʘ	K. / AD.
OSKA-313	Cerman Menteşe (8 mm)	13.00	1 Dz.
OSKA-313-1	Cerman Menteşe (5 mm)	12.00	1 Dz.
OSKA-314	Cerman Menteşe (10 mm)	16.00	1 Dz.
OSKA-316	175 cm. Boy Ment.Beyaz (060 mm Sac)	2.70	50
OSKA-316-1	175 cm. Boy Ment.Beyaz (080 mm Sac)	3.70	50

## YAPRAK MENTEŞELER

## 40 x 40 YAPRAK MENTEŞELER

KOD	Cinsi	AD. / ʘ	K. / AD.
OSKA-317	40 x 40 ( STATİK BOYALI )	1.60	100
OSKA-317-1	40 x 40 (KENDİNDEN CİVATALI- BOYALI )	2.10	100
OSKA-317-1-2	40 x 40 (TEK TARAFI CİVATALI- BOYALI )	2.00	100
OSKA-321	40 x 40 ( KROM KAPLAMALI )	1.90	100
OSKA-321-1	40 x 40 (KENDİNDEN CİVATALI- KROM KAP)	2.40	100
OSKA-321-1-2	40 x 40 (TEK TARAFI CİVATALI- KROM KAP)	2.20	100
OSKA-325	40 x 40 ( PLASTİK )	1.00	500

## 50 x 50 YAPRAK MENTEŞELER

OSKA-318	50 x 50 ( STATİK BOYALI )	2.10	100
OSKA-318-1	50 x 50 (KENDİNDEN CİVATALI- BOYALI )	2.60	100
OSKA-318-1-2	50 x 50 (TEK TARAFI CİVATALI- BOYALI )	2.40	100
OSKA-322	50 x 50 ( KROM KAPLAMALI )	2.50	100
OSKA-322-1	50 x 50 (KENDİNDEN CİVATALI- KROM KAP)	3.00	100
OSKA-322-1-2	50 x 50 (TEK TARAFI CİVATALI- KROM KAP)	2.80	100
OSKA-326	50 x 50 ( PLASTİK )	1.10	500

## 50 x 63 YAPRAK MENTEŞELER

OSKA-319	50 x 63 (STATİK BOYALI)	2.60	100
OSKA-323	50 x 63 (KROM KAPLAMALI)	3.00	100
OSKA-327	50 x 63 (PLASTİK)	1.20	500

## 50 x 76 YAPRAK MENTEŞELER

OSKA-320	50 x 76 (STATİK BOYALI)	2.80	100
OSKA-324-1-2	50 x 76 (STATİK BOYALI)	2.80	100
OSKA-324	50 x 76 (KROM KAPLAMALI)	3.30	100
OSKA-324-1	50 x 76 (KROM KAPLAMALI)	3.30	100
OSKA-328	50 x 76 (PLASTİK)	1.40	500

## 60 x 60 YAPRAK MENTEŞELER

OSKA-329	60 x 60 (KENDİNDEN CİVATALI- BOYALI)	5.40	100
OSKA-329-1	60 x 60 (TEK TARAF CİVATALI BOYALI)	5.60	100
OSKA-329-1-2	60 x 60 (STATİK BOYALI)	4.60	100
OSKA-329-2	60 x 60 (KENDİNDEN CİVATALI- KROM KAP)	5.70	100
OSKA-329-2-1	60 x 60 (TEK TARAF CİVATALI-KAPLAMALI)	5.50	100
OSKA-329-2-2	60 x 60 (KAPLAMALI)	5.00	100

## 60 x 90 YAPRAK MENTEŞELER

OSKA 350	60 x 90 (KENDİNDEN CİVATALI- BOYALI)	6.60	100
OSKA 350-1	60 x 90 (TEK TARAF CİVATALI BOYALI)	6.00	50
OSKA 350-1-2	60 x 90 (STATİK BOYALI)	5.60	50
OSKA 352	60 x 90 (KENDİNDEN CİVATALI- KROM KAP)	7.00	50
OSKA 352-1	60 x 90 (TEK TARAF CİVATALI-KAPLAMALI)	6.60	50
OSKA 352-1-2	60 x 90 (KAPLAMALI)	6.00	50

## 60 x 120 YAPRAK MENTEŞELER

OSKA 351	60 x 120 (KENDİNDEN CİVATALI- BOYALI)	6.40	50
OSKA 351-1	60 x 120 (TEK TARAF CİVATALI BOYALI)	6.00	50
OSKA 351-1-2	60 x 120 (STATİK BOYALI)	5.80	50
OSKA 353	60 x 120 (KENDİNDEN CİVATALI- KROM KAP)	7.60	50
OSKA 353-1	60 x 120 (TEK TARAF CİVATALI-KAPLAMALI)	7.60	50
OSKA 353-1-2	60 x 120 (KAPLAMALI)	7.00	50







## KABİN KİLİTLERİ

KOD	CİNSİ	AD. / ʈ	K. / AD.
OSKA-252	Kabin Kilidi	22.00	30
OSKA-252-1	Kabin Kilidi Karşılığı	3.00	30
OSKA-253	Kabin Kilidi (Paslanmaz)	34.00	30
OSKA-254	Kabin Kil. (Siyah-Statik-Boyali-A.Ham.)	26.00	30
OSKA-260	Plastik Kabin Kilidi - YENİ	14.00	50



## KULPLAR

KOD	CİNSİ	AD. / ʈ	K. / AD.
OSKA-109	Çekmece Kulpu (Zamak 70mm)	1.60	50
OSKA-215	Armut Kulpu (Plastik M5)	0.30	1000
OSKA-703	PVC Kulpu (Elçek)	1.20	100
OSKA-706/115	Kapak Kulpu (Plastik)	1.60	100
OSKA-706/122	Kapak Kulpu (Plastik)	1.80	100
OSKA-706/A2	Makina Kapak Kulpu (L=200)	2.60	50
OSKA-706/A3	Makina Kapak Kulpu (L=300)	2.90	50
OSKA-706/A4	Makina Kapak Kulpu (L=400)	3.20	50
OSKA-706/A5	Makina Kapak Kulpu (L=500)	3.40	50
OSKA-720	Plastik Kulpu (M6-Pirinç Kör Som)	0.60	500
OSKA-720/1	Plastik Kulpu (M6)	0.26	500



## KAPUT MANDALLARI

KOD	CİNSİ	AD. / ʈ	K. / AD.
OSKA-721	Kaput mandalı büyük	1.90	100
OSKA-721-1	Kaput mandalı küçük	1.70	100



## ASKI KULAĞI VE MAPALAR

KOD	CİNSİ	AD. / ʈ	K. / AD.
OSKA-705	Metal Takviyeli - Plastik - Pano Askı Kulağı	1.90	100
OSKA-709	M8 Aybolt (Mapa)	1.40	100
OSKA-710	M10 Aybolt (Mapa)	2.00	100
OSKA-711	M12 Aybolt (Mapa)	2.80	50
OSKA-711/1	M14 Aybolt (Mapa)	4.60	50
OSKA-711/2	M16 Aybolt (Mapa)	4.60	50



## PLASTİK BAŞLI VİDALAR

KOD	CİNSİ	AD. / ʈ	K. / AD.
OSKA 707-TB-20	CİVA. M6 x 20 (YILDIZ TORNAVİDA BAŞLI)	0.28	100
OSKA 707-TB-25	CİVA. M6 x 25 (YILDIZ TORNAVİDA BAŞLI)	0.30	100
OSKA 707-TB-30	CİVA. M6 x 30 (YILDIZ TORNAVİDA BAŞLI)	0.32	100
OSKA 707-TB-35	CİVA. M6 x 35 (YILDIZ TORNAVİDA BAŞLI)	0.34	100
OSKA 707-10	M6 x 10 PLS. BAŞLI CİVATA	0.22	100
OSKA 707-15	M6 x 15 PLS. BAŞLI CİVATA	0.24	100
OSKA 707-20	M6 x 20 PLS. BAŞLI CİVATA	0.26	100
OSKA 707-25	M6 x 25 PLS. BAŞLI CİVATA	0.28	100
OSKA 707-30	M6 x 30 PLS. BAŞLI CİVATA	0.30	100
OSKA 707-35	M6 x 35 PLS. BAŞLI CİVATA	0.32	100



## SOMUNLAR

KOD	CİNSİ	AD. / ʈ	K. / AD.
OSKA-708	M6 Kafes Somun (1.7 - 2.5 mm Saçlar İçin)	0.20	500
OSKA-708/1	M8 Kafes Somun (3.2 - 4.1 mm Saçlar İçin)	0.44	500
OSKA-708/2	M5 Kafes Somun (1.7 - 2.5 mm Saçlar İçin)	0.20	500
OSKA-716	3/16 Kelebek Somun	0.06	5000
OSKA-716/1	M5 Kelebek Somun	0.06	5000
OSKA-716/2	M6 Kelebek Somun	0.06	5000
OSKA-716/3	M6 Kelebek Somun (Çelik)	0.20	100

## PROJE CEPLERİ



KOD	CİNSİ	AD. / ʘ	K. AD.
OSKA-226	Küçük - Yapışkan Bantlı	2.70	50
OSKA-227	Büyük - Yapışkan Bantlı	3.20	50

## SAYAÇ CAMLARI VE ÇERÇEVELERİ



KOD	CİNSİ	AD. / ʘ	K. AD.
OSKA-225	Plastik Çerçeve	0.30	500
OSKA-702	Sayaç Çerçeve	1.40	100
OSKA-717	Monofaze Sayaç Camı	2.40	100
OSKA-718	Trifaze Sayaç Camı	3.80	100
OSKA-719	Trifaze Sayaç Camı (Büyük)	8.00	100

## KABİN LASTİKLERİ



KOD	CİNSİ	MT. / ʘ	K. MT.
OSKA-402	Tel Örgülü İpli-Yandan Borulu	3.60	100
OSKA-402-1	Tel Örgülü İpli-Yandan Borulu-Çift Tırnaklı	3.60	100
OSKA-402-2	Tel Örgülü İpli-Üsten Borulu-Çift Tırnaklı	3.60	50
OSKA-402-3	PVC + Sünger - Yandan Borulu	3.60	100
OSKA-402-4	PVC + Sünger - Yandan Borulu - Küçük	3.60	100
OSKA-402-5	PVC+Sünger-Yandan Borulu-Küçük-Çift T.	3.60	100
OSKA-402-6	PVC+Sünger-Yandan Borulu-Çift Tırnaklı	3.60	100

## KABİN CAM LASTİKLERİ



KOD	CİNSİ	MT. / ʘ	K. MT.
OSKA-400-1	15 x 3 mm, 4 mm Oring dahil	6.00	50
OSKA-400-2	19 x 3 mm, 6 mm Oring dahil	7.00	50
OSKA-400-3	23.5 x 5 mm, 6 mm Oring dahil	7.60	50

## RACK KABİN FIRÇASI



KOD	CİNSİ	MT. / ʘ	K. MT.
OSKA-024	Kıl Kalınlığı 0.25-040mm Kıl Boyu : 5 cm	22.00	10
OSKA-025	Kıl Kalınlığı 0.25-040mm Kıl Boyu : 10 cm	42.00	10

## SAC KENAR FİTİLLERİ



KOD	CİNSİ	MT. / ʘ	K. MT.
OSKA-401	U-1 (İnce/Siyah-Kırmızı/Gri)	0.46	100
OSKA-403	U-1 (Kalın/Siyah-Kırmızı/Gri)	0.56	100

## POLİETİLEN CONTALAR

## 3 mm Polietilen Contalar

OSKA-KOD	Boyut	MT. / ʘ	K. MT.
OSKA-411	3*10 Yapışkanlı	0.30	25
OSKA-412	3*15 Yapışkanlı	0.40	25
OSKA-413	3*20 Yapışkanlı	0.48	25
OSKA-414	3*25 Yapışkanlı	0.56	25
OSKA-415	3*30 Yapışkanlı	0.70	25
OSKA-416	3*35 Yapışkanlı	0.84	25
OSKA-417	3*40 Yapışkanlı	0.96	25

## 5 mm Polietilen Contalar

KOD	CİNSİ	MT. / ʘ	K. MT.
OSKA-404	5*10 Yapışkanlı	0.38	20
OSKA-405	5*15 Yapışkanlı	0.50	20
OSKA-406	5*20 Yapışkanlı	0.60	20
OSKA-407	5*25 Yapışkanlı	0.70	20
OSKA-408	5*30 Yapışkanlı	0.80	20
OSKA-409	5*35 Yapışkanlı	0.90	20
OSKA-410	5*40 Yapışkanlı	1.00	20

## 10 mm Polietilen Contalar

OSKA-KOD	Boyut	MT. / ʘ	K. MT.
OSKA-421	10*10 Yapışkanlı	0.56	10
OSKA-422	10*15 Yapışkanlı	0.84	10
OSKA-423	10*20 Yapışkanlı	0.98	10
OSKA-424	10*25 Yapışkanlı	1.20	10
OSKA-425	10*30 Yapışkanlı	1.54	10
OSKA-426	10*35 Yapışkanlı	1.76	10
OSKA-427	10*40 Yapışkanlı	1.90	10

## EPDM CONTALAR

## 3 mm EPDM Contalar

KOD	CİNSİ	MT. / ʘ	K. MT.
OSKA-431	3*10 Yapışkanlı	0.56	10
OSKA-432	3*15 Yapışkanlı	0.80	10
OSKA-433	3*20 Yapışkanlı	1.08	10
OSKA-434	3*25 Yapışkanlı	1.34	10
OSKA-435	3*30 Yapışkanlı	1.68	10
OSKA-436	3*35 Yapışkanlı	1.82	10

## 5 mm EPDM Contalar

OSKA-KOD	Boyut	MT. / ʘ	K. MT.
OSKA-441	5*10 Yapışkanlı	0.78	10
OSKA-442	5*15 Yapışkanlı	0.98	10
OSKA-443	5*20 Yapışkanlı	1.30	10
OSKA-444	5*25 Yapışkanlı	1.60	10
OSKA-445	5*30 Yapışkanlı	1.90	10
OSKA-446	5*35 Yapışkanlı	2.24	10

## MONTAJ BANTLARI

KOD	CİNSİ	MT. / ʘ	K. MT.
OSKA-451	1*10 Çift Taraflı Yapışkanlı	0.60	50
OSKA-452	1*20 Çift Taraflı Yapışkanlı	0.80	50
OSKA-453	2*20 Çift Taraflı Yapışkanlı	1.20	25

## DC FANLAR



KOD	VOLT	AÇIKLAMA	AD. / \$	K. AD.
060-060-025/09	024 DC	60 x 60 x 25	2.50 \$	100
080-080-025/13	012 DC	80 x 80 x 25	2.50 \$	100
120-120-038/11	024 DC	120 x 120 x 25 – 38	4.70 \$	40
120-120-038/22	048 DC	120 x 120 x 38	6.70 \$	40
172-150-51/10	24 DC	172 x 150 x 51	16.70 \$	40

## AC FANLAR



KOD	VOLT	AÇIKLAMA	AD. / \$	K. AD.
080-080-025/07	024 DC	80 x 80 x 25	5.00 \$	100
080-080-038/05	012 DC	80 x 80 x 35	5.00 \$	50
090-090-025/18	024 DC	90 x 90 x 25	5.00 \$	50
120-120-025/01	048 DC	120 x 120 x 25 (Kablolu)	5.00 \$	50
120-120-038/14	24 DC	120 x 120 x 31	5.60 \$	40
120-120-038/01	24 DC	120 x 120 x 38 (Kablolu)	5.00 \$	40
120-120-038/02	24 DC	120 x 120 x 38 (Soketli)	5.00 \$	40
220-060/16	220 AC	Ø 210 x 60	22.50 \$	40
172-150-51/04	220 AC	172 x 150 x 51	16.50 \$	40
172-150-151/31	115 AC	172 x 150 x 51	16.70 \$	40

## SALZER YÜKSEK PERFORMANS FAN SETLERİ



KOD	VOLT	AÇIKLAMA	AD. / \$
FAN21	230 VAC	120 x 120 x 38 Sleeve Kablolu	8.50 \$
FAN36	230 VAC	120 x 120 x 38 Sleeve Soketli	8.50 \$
FAN37	230 VAC	120 x 120 x 25 Sleeve Kablolu	8.50 \$
FAN26	230 VAC	120 x 120 38 Ball Rulmanlı	13.50 \$
FAN32	230 VAC	120 x 120 x 38 Metal Rulmanlı	20.00 \$
FAN27	230 VAC	80 x 80 x 25 / 38	8.50 \$
FAN24	230 VAC	162 x 150 x 55 Rulmanlı	43.50 \$
FAN33	230 VAC	172 x 150 x 51 Rulmanlı	22.50 \$
FAN19	230 VAC	225 x 225 x 80 Rulmanlı	78.00 \$
FAN34	230 VAC	Ø 230 x 65 Rulmanlı	44.50 \$
FAN35	24 VDC	80 x 80 x 25 24 VDC	4.00 \$
FAN38	24 VDC	120 x 120 x 25 24 VDC	8.50 \$
FAN39	230 VAC	Ø 220 x 60 Ball Jiu Long-Rulmanlı	39.00 \$
FAN40	24 VDC	120 x 120 x 38 24 VDC	8.50 \$

## FAN AKSESUARLARI



KOD	VOLT	AÇIKLAMA	AD. / \$	K. AD.
MK080/08	080-080	METAL KORUMA KAPAĞI	0.45 \$	10
MK120/03	120-120	METAL KORUMA KAPAĞI	0.50 \$	10
MK172/06	172-150	METAL KORUMA KAPAĞI	0.80 \$	10
MK280/41	280-280	METAL KORUMA KAPAĞI	14.50 \$	10

## HAVALANDIRMA PANJURLARI



KOD	AÇIKLAMA	AD. / ₺	K. AD.
OSKA-701	150 x 150 mm - Elyaflı	4.00	50
OSKA-701/1	150 x 150 mm - Elyaflı Siyah	4.00	50
OSKA-701/2	250 x 250 mm - Elyaflı	14.00	10
OSKA-701/2-2	250 x 250 mm - Fan Aparatı (ABS)	8.00	10
OSKA-704/2	Fan Teli (17x15 Fan İçin)	2.60	10
OSKA-726	PLS Panjur	1.40	50

## PANO İÇİ AKSESUARLARI ve EKSPANLAMA KLEMENSLERİ

## KABLO EKSPANLAMA KLEMENSLERİ



KOD	CİNSİ	AD. / t
SF-SK 3-8	3 - 8 mm 18 x 14 x 26	☺
SF-SK 4-13.5	4 - 13.5 mm 20 x 20 x 31	☺
SF-SK 10-20	10 - 20 mm 16 x 24 x 40	☺
SF-SK 15-32	15 - 32 mm, 32 x 35 x 64	☺
SK 3-8	3-8 mm 18 x 14 x 26	☺
SK 4-13.5	4-13.5 mm 20 x 20 x 31	☺
SK 10-20	10 - 20 mm 26 x 24 x 40	☺
SK 15-32	15 - 32 mm 32 x 35 x 64	☺
SS-SK 3-8	3 - 8 mm 32 x 35 x 64	☺
SS-SK 4-13.5	4 - 13.5 mm 18 x 14 x 26	☺
SS-SK 10-20	10 - 20 mm 20 x 20 x 31	☺

## KABLO EKSPANLAMA KLEMENSLERİ



KOD	KALINLIK	AD. / t
SF-SKL1.5-3	1.5 - 3.0	☺
SF-SKL3-6	3.0 - 6.0	☺
SF-SKL6-8	6.0 - 8.0	☺
SF-SKL9-11	9.0 - 11	☺
SF-SKL12-16	12 - 16	☺
SF-SKL17-22	17 - 22	☺
SF-SKL23-29	23 - 29	☺

## KABLO TUTUCU PLAKALAR

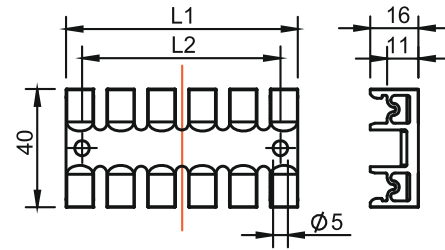
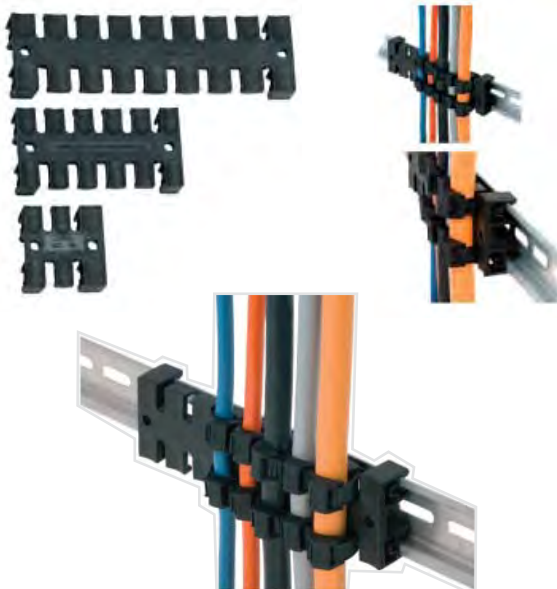

KOD	ÖLÇÜLER		AD. t
	L1	L2	
KZL 39	38.5 mm	28.3 mm	☺
KZL 80	79.5 mm	68.0 mm	☺
KZL 140	139.5 mm	128.1 mm	☺



**POLYOLEFİN MALZEMEDEN İMAL 2/1 ORANINDA DARALAN**  
**UL ww-1 SERTİFİKALI RoHS, ISO BELGELİ 600 V ÇALIŞMA SICAKLIĞI -55C + 125 °C**

KOD	MM	INC	AD. / \$	K. AD.
K-53000	1		0.078 \$	200
K-53001	1.2		0.078 \$	200
K-53002	1.5		0.078 \$	200
K-53003	1.6	1/16	0.078 \$	200
K-53004	2		0.081 \$	200
K-53005	2.4	3/32	0.084 \$	200
K-53006	2.5		0.090 \$	200
K-53007	3		0.106 \$	200
K-53008	3.2	1/8	0.106 \$	200
K-53009	3.5		0.111 \$	200
K-53010	4		0.120 \$	200
K-53011	4.5		0.132 \$	100
K-53012	4.8	3/16	0.132 \$	100
K-53013	5		0.144 \$	100
K-53014	6		0.156 \$	100
K-53015	6.4	1/4	0.156 \$	100
K-53016	7		0.172 \$	100
K-53017	8		0.186 \$	100
K-53018	9		0.198 \$	50
K-53019	9.5	3/8	0.198 \$	100
K-53020	10		0.210 \$	100
K-53021	11		0.222 \$	100
K-53022	12		0.252 \$	100
K-53023	12.7	1/2	0.252 \$	100
K-53024	13		0.276 \$	100
K-53025	14		0.324 \$	100
K-53026	16		0.480 \$	100
K-53027	17		0.575 \$	100
K-53028	18		0.600 \$	100
K-53029	19.1	3/4	0.600 \$	100
K-53030	20	4/5	0.708 \$	100
K-53031	22		0.816 \$	100
K-53032	25.4	1	0.864 \$	50
K-53033	30		1.560 \$	50
K-53034	32	1-1/4	1.560 \$	50
K-53035	35		1.980 \$	50
K-53036	38	1-1/2	2.016 \$	50
K-53037	40		2.04 \$	50
K-53038	51	2	3.00 \$	25
K-53039	60		4.44 \$	25
K-53040	70		5.76 \$	25
K-53041	76	3	6.00 \$	25
K-53042	80		6.60 \$	25
K-53043	90		7.56 \$	25
K-53044	102	4	7.80 \$	25
K-53045	120	5	12.00 \$	20
K-53046	150		18.00 \$	20
K-53047	180		24.00 \$	20

MM	MM	INC	M. / \$	K. AD.	M. / \$ K.RENGİ	M. / \$ SARI-YEŞİL
ŞEFFAF	1,6	1/16	0.084 \$	200	-	-
	2,4	3/32	0.096 \$	200	0.120 \$	0.30 \$
	2,5		0.132 \$	200	-	-
BEYAZ	3,2	1/8	0.144 \$	200	0.192 \$	0.324 \$
	3,5		0.156 \$	200	-	-
	4,8	3/16	0.174 \$	100	0.265 \$	0.372 \$
SARI	5		0.192 \$	100	-	-
	6,4	1/4	0.210 \$	100	0.333 \$	0.408 \$
	7		0.228 \$	100	-	-
MAVİ	9,5	3/8	0.276 \$	100	0.426 \$	0.576 \$
	10		0.300 \$	100	-	0.660 \$
	12		0.360 \$	100	-	-
KIRMIZI	12,7	1/2	0.380 \$	100	0.534 \$	0.720 \$
	16		0.672 \$	100	-	1.020 \$
	19,1	3/4	0.936 \$	100	-	1.320 \$
YEŞİL	20	4/5	1.100 \$	100	1.458 \$	1.488 \$
	25,4	1	1.488 \$	50	1.932 \$	1.980 \$
	32	1-1/4	1.980 \$	50	2.580 \$	2.678 \$
GRİ	35		2.760 \$	50	-	3.373 \$
	38	1-1/2	3.180 \$	50	3.970 \$	3.540 \$
	51	2	3.480 \$	50	4.620 \$	5.955 \$
	70		6.120 \$	25	-	-
	76	3	6.804 \$	25	-	11.70 \$

**3/1 İÇİ YAPIŞKANLI DARALAN MAKARON**

Daralmadan Önce mm	Daralmadan Sonra mm	M. / \$	K. AD.
3.2	1	1.20	200 m
4.8	1.6	1.32	100 m
6.4	2	1.68	100 m
9.5	3	2.22	50 m
10	3	2.30	1.20 Boy
12.7	4	2.40	1.20 Boy
19.1	5.6	3.60	1.20 Boy
28	9	6.12	1.20 Boy
30	10	7.20	120 Boy
35	10	7.35	1.20 Boy
38	13	8.52	1.20 Boy
43.2	12.7	10.42	1.20 Boy
52	16	12.30	1.20 Boy
75	22	19.00	1.20 Boy
95	29	27.00	1.20 Boy

## KABLO TOPLAMA ÇORABI



KOD	MİN. TUTMA ÇAPI	MAX. TUTMA ÇAPI	M. / €	K. AD.
OR - 3	3	7	0.35 €	100
OR - 6	6	13	0.42 €	100
OR - 8	8	11	0.55 €	100
OR - 10	10	15	0.65 €	100
OR - 12	12	19	0.80 €	50
OR - 15	15	27	1.05 €	50
OR - 20	20	28	1.15 €	50
OR - 25	25	34	1.40 €	25
OR - 30	30	37	1.70 €	25
OR - 40	40	45	2.40 €	25
OR - 50	50	65	2.70 €	25

## HELEZON PANO SİRALLERİ

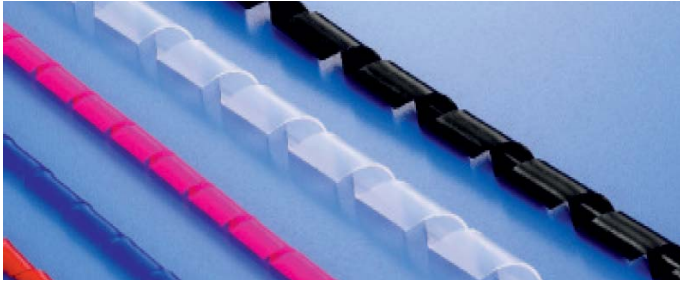

KOD	İÇ ÇAP	DIŞ ÇAP	MT. / ʘ	MT.
TORK TSPR6	4.1	6.2	0,266	10
TORK TSPR8	6.0	8.0	0,336	10
TORK TSPR10	7.5	10.0	0,630	10
TORK TSPR12	9.0	12.0	0,840	10
TORK TSPR15	12.0	15.0	0,910	10

## KABLO TOPLAMA SİRALLERİ



KOD	MİN. TUTMA ÇAPI	M. / ʘ	MT.
TORK TTSPR8	Siyah	1,540	5
TORK TTSPR15	Siyah	2,170	5
TORK TTSPR20	Siyah	3,220	5
TORK TTSPR 25	Siyah	4,390	5
TORK TTSPR32	Siyah	7,000	5

## 2.5 KV - CAM ELYAF MAKARONLAR



KOD	KESİT	M. / \$	K. AD.
EMTİ - CE 080	0.80	0.049 \$	100
EMTİ - CE 1	1	0.049 \$	100
EMTİ - CE 1,5	1,5	0.064 \$	100
EMTİ - CE 2	2	0.072 \$	100
EMTİ - CE 2,5	2,5	0.080 \$	100
EMTİ - CE 3	3	0.094 \$	100
EMTİ - CE 4	4	0.128 \$	100
EMTİ - CE 5	5	0.233 \$	100
EMTİ - CE 6	6	0.248 \$	100
EMTİ - CE 7	7	0.310 \$	50
EMTİ - CE 8	8	0.327 \$	50
EMTİ - CE 10	10	0.475 \$	50
EMTİ - CE 12	12	0.601 \$	50
EMTİ - CE 14	14	0.756 \$	50
EMTİ - CE 16	16	1.349 \$	50
EMTİ - CE 18	18	1.494 \$	50
EMTİ - CE 20	20	2.344 \$	25
EMTİ - CE 25	25	5.184 \$	25

## 6 KV H KLAS CAM+SİLİKON İZOLELİ MAKARONLAR



KOD	KESİT	M. / €	K. AD.
EMTİ - CS 1	1	0.285 €	200
EMTİ - CS 1,5	1,5	0.340 €	200
EMTİ - CS 2	2	0.408 €	200
EMTİ - CS 2,5	2,5	0.435 €	200
EMTİ - CS 3	3	0.545 €	100
EMTİ - CS 3,5	3,5	0.627 €	100
EMTİ - CS 4	4	0.708 €	100
EMTİ - CS 5	5	0.844 €	100
EMTİ - CS 6	6	1.000 €	100
EMTİ - CS 7	7	1.300 €	100
EMTİ - CS 8	8	1.499 €	100
EMTİ - CS 10	10	1.539 €	100
EMTİ - CS 12	12	2.248 €	50
EMTİ - CS 14	14	2.738 €	50
EMTİ - CS 16	16	3.545 €	50
EMTİ - CS 18	18	4.295 €	50
EMTİ - CS 20	20	4.905 €	25
EMTİ - CS 25	25	10.219 €	25
EMTİ - CS 30	30	13.625 €	25
EMTİ - CS 35	35	16.487 €	25
EMTİ - CS 40	40	20.029 €	25

**ERİYEN BANTLAR (U.D.)**



KOD	KESİT	M. / \$
BANT-19	19 mm x 0,8 mm x 8 mt 6-10 kV	☎
BANT-50	50 mm x 0,8 mm x 8 mt 6-10 kV	☎

**ERİYEN BANTLAR (SCAPA)**



KOD	KESİT	M. / €
SCAP-2501	19 mm x 0.50 mm x 10 yrd	4.75 €

**İZOLE BANT ÇEŞİTLERİ**



KOD	KESİT	RENK	M. / \$
GL-001	15 mm x 10 yrd.	Karışık Renkli	☎
GL-002	19 mm x 10 yrd	Karışık Renkli	☎
GL-003	50 mm x 25 yrd	Karışık Renkli	☎
YT-001	19 mm x 10 yrd	Siyah	☎
YT-002	30 mm x 25 mt	Siyah	☎
YT-003	50 mm x 25 mt	Siyah	☎
YT-004	19 mm x 25 mt	Siyah	☎
YT-005	19 mm x 10 yrd	Sarı - Yeşil	☎

**TEFLON BANTLAR**



KOD	KESİT	AD. / ı
TEFL - 001	12 mm x 0.076 mm 12 mm	☎

**KOLİ BANDI**



KOD	KESİT	AD. / ı
KLBO1	45 mm x 40 mt. Şef. Kah.	☎

**ELEKTRONİK BANT ARMATÜRLER**



KOD	CİNSİ	AD. / ı	K. AD.
LAMP-LP 04001	6 W T5 Ekleme Anahtarlı	☎	1
LAMP-LP 04002	8 W T5 Ekleme Anahtarlı	☎	1
LAMP-LP 04003	13 W T5 Ekleme Anahtarlı	☎	1
LAMP-LP 04004	8 W T5 Oynar Başlı	☎	1
LAMP-LP 04005	13 W T5 Oynar Başlı	☎	1
LAMP-LP 04006	8 W T5 Prizli Armatür	☎	1

**RALİNA DUYLAR; 35 W, 60 W**



KOD	CİNSİ	AD. / ı	K. AD.
SEBA - 91141	Düz	☎	24
SEBA - 91142	İpli	☎	24
SEBA - 91143	Anahtarlı	☎	24
SEBA - 91144	35 W Ralina	☎	30
SEBA - 91140	60 W Ralina	☎	30
SEBA-RLS001	Ralina Switch	☎	100

**LED'Lİ ŞARJLI IŞILDAKLAR**



KOD	CİNSİ	AD. / ı
PT-8828 60	LED Işıldak Pili	☎
PT-330L 60	LED Işıldak Şarjlı 6.4 Akülü	☎
PT-330L 120	LED Işıldak Şarjlı 6.4 Akülü	☎

**ÇİFT TARAFLI BANTLAR**



## SPREY ÇEŞİTLERİ



PERFECTS



YAĞSIZ KONTAK SPREY 200 ml



PERFECTS



YAĞLI KONTAK SPREY 200 ml



PERFECTS



KÖPÜK TEMİZLEYİCİ SPREY 200 ml



PERFECTS



LCD EKRAN TEMİZ. SPREY 200 ml



HAWCON



YAĞSIZ KONTAK SPREY 200 ml



HAWCON



YAĞLI KONTAK SPREY 200 ml



WD-40



PAS SÖKÜCÜ SPREY 200/400 ml



BETA



PLASTİK KONTAK SPREY 200 ml



BETA



PAS SÖKÜCÜ KONTAK SPREY 200 ml



WINKEL



ÇOK AMAÇLI PAS SÖK. SPREY 400 ml



WINKEL



ANTİSTATİK SPREY 400 ml



WINKEL



SOĞUTUCU SPREY 400 ml



WINKEL



KUVVETLİ PAS SÖK. SPREY 400 ml



WINKEL



SPREY VERNİK ŞEFFAF 400 ml



WINKEL



SPREY VERNİK KIRMIZI 400 ml